



View this document in HTML
crestron.com/docs/9462



Product Manual

DGE-1000

Digital Graphics Engine 1000

Have feedback on this document? Contact docfeedback@crestron.com.

The original language version of this document is U.S. English.
All other languages are a translation of the original document.

Regulatory Model: M202011001

Crestron product development software is licensed to Crestron dealers and Crestron Service Providers (CSPs) under a limited nonexclusive, nontransferable Software Development Tools License Agreement. Crestron product operating system software is licensed to Crestron dealers, CSPs, and end-users under a separate End-User License Agreement. Both of these Agreements can be found on the Crestron website at www.crestron.com/legal/software_license_agreement.

The product warranty can be found at www.crestron.com/warranty.

The specific patents that cover Crestron products are listed online at www.crestron.com/legal/patents.

Certain Crestron products contain open source software. For specific information, please visit www.crestron.com/opensource.

Crestron, the Crestron logo, AirMedia, Crestron Home, DigitalMedia, DM, and XiO Cloud are either trademarks or registered trademarks of Crestron Electronics, Inc. in the United States and/or other countries. HDMI, and the HDMI logo are either trademarks or registered trademarks of HDMI Licensing LLC in the United States and/or other countries. Active Directory, Azure, and Microsoft are either trademarks or registered trademarks of Microsoft Corporation in the United States and/or other countries. JavaScript is either a trademark or registered trademark of Oracle Corporation in the United States and/or other countries. DisplayPort is either a trademark or a registered trademark of Video Electronics Standards Association in the United States and/or other countries. Wi-Fi is either a trademark or registered trademark of Wi-Fi Alliance in the United States and/or other countries. Other trademarks, registered trademarks, and trade names may be used in this document to refer to either the entities claiming the marks and names or their products. Crestron disclaims any proprietary interest in the marks and names of others. Crestron is not responsible for errors in typography or photography.

©2024 Crestron Electronics, Inc.

Contents

- DGE-1000** 1
- Features** 2
- Specifications** 6
 - Product Specifications 6
 - Dimension Drawings 9
- Installation** 10
 - In the Box 10
 - Installation 11
 - Mount onto a Rack Rail 11
 - Mount onto a Flat Surface 12
 - Connections 13
 - Observe the LEDs 14
- Configuration** 15
 - Web Configuration 16
 - Action 18
 - Status 28
 - Settings 35
- Resources** 61
 - Crestron Support and Training 61
 - Programmer and Developer Resources 61
 - Product Certificates 61

DGE-1000

Digital Graphics Engine 1000

The Crestron® DGE-1000 digital graphics engine transforms an HD touch screen display into an advanced Crestron controller. The DGE-1000 features [Crestron HTML5](#) technology that may be used to create a custom graphical environment for controlling audio, video, lighting, shades, HVAC, security, and other amenities. It is also used for functions with dual-window video display and web browsing. Its low-profile, surface-mountable design allows for discreet installation behind a flat-panel display, under a table, or inside a lectern or equipment rack.

The DGE-1000 offers an HDMI® output to connect a display device, and includes two USB HID ports for touch screen, mouse, or keyboard input. Additional control ports are provided for controlling the display device and other equipment. The HDMI input allows an AirMedia® wireless presentation gateway or other high-definition video source to be connected and displayed onscreen. Additionally, H.264/H.265 and MJPEG streaming video signals can be received over a high-speed Ethernet connection, which also provides an interface to a Crestron control system.¹

Features



Key features include:

- Touch screen graphics engine for the Crestron® TSD-2220 or a third-party USB HID-compliant touch screen
- HDMI® output supports display resolutions up to 3840x2160@60Hz (2160p60)
- Displays dual-window or full screen video from HDMI and H.264 streaming sources
- Supports video input resolutions up to 1080p60 via HDMI
- Receives H.264 streaming video signals up to 1080p60/25 Mbps
- HDCP 1.4 compliant (HDMI only)
- Crestron® HTML5 technology used for custom user projects
- Built-in web browsing
- Supports Crestron Home® and Crestron General Web apps
- Onboard COM, HDMI, IR/serial, and high-speed Ethernet ports
- High-speed USB 2.0, 3.0 ports for USB HID-compliant peripheral devices
- Powered via PoE+ or power pack (sold separately)
- Enterprise-grade security and authentication
- Web or cloud-based configuration
- Compact, surface-mountable form factor

Touch Screen Interface

The DGE-1000 can be paired with the [TSD-2220](#) HD touch screen display to deliver a high-definition 21.5 in. touch screen control panel that is ideal for home, corporate, and government applications. It is also compatible with third-party touch screen displays to support a range of control, collaboration, video display, and interactive kiosk solutions.

Crestron HTML5 Technology

Crestron HTML5 User Interface is a collection of design components used for creating a JavaScript™ programming library that is compatible with HTML5. This library allows web application developers to create UI projects that communicate to Crestron control systems instead of normal HTTP servers.

HD Streaming Video

The DGE-1000 supports high-definition streaming video, making it possible to view security cameras and other video sources over the network via the touch screen display. Native support for H.264, H.265 and MJPEG formats allows the DGE-1000 to display live streaming video from an IP camera, a streaming encoder ([DM-TXRX-100-STR](#) or similar), or a [DigitalMedia™ switcher](#).¹

HDMI Input

An HDMI input is provided for connecting and displaying an HD video source. Wireless presentation is also supported by connecting an [AirMedia® gateway](#) to the HDMI input, allowing for laptops and mobile devices to connect to the DGE-1000 over Wi-Fi® communications.²

HDCP Support

Support for HDCP (High-bandwidth Digital Content Protection) ensures seamless compatibility with content-protected optical disc, television, and streaming sources.

Web Browsing

Using its built-in Crestron General Web app or a web browser, the DGE-1000 provides access to online program guides and other web-based services. It can also be used to control DVRs and other devices.³

Onscreen Keyboard

Typing in passwords, URLs, and text searches is facilitated using the onscreen multi-language keyboard.

Onboard Control Ports

The DGE-1000 provides built-in RS-232 and IR ports for programmable control of the connected display and other devices via a control system. When connected to a control system via Ethernet, the DGE-1000 offers a gateway for controlling the display device directly through its HDMI connection, which reduces the need for dedicated serial cables or IR emitters. Additional control capabilities are available by using CEC (Consumer Electronics Control) that is embedded within the HDMI out signal.

Low-Profile Installation

The DGE-1000 mounts conveniently to a wall, ceiling, or other flat surface. Its compact, surface-mountable form factor fits easily behind a flat panel display, beneath a tabletop, or inside a lectern or other furniture. It can even be attached directly to a single rack rail in the back of an equipment cabinet. The DGE-1000 can be powered using the included wall mount power pack or via PoE (Power over Ethernet) for a true single-wire solution.

Crestron Home® OS Control

The DGE-1000 can be used to control a [Crestron Home OS](#) whole home solution via a connected [TSD-2220](#) or third-party touch screen display. Select the Crestron Home app from the connected display to control lighting, shades, climate, media, security, and cameras, including the ability to create and recall scenes that create a desired ambiance throughout a home. Additionally, the DGE-1000 supports streaming high-definition video to the connected display directly from the Crestron Home app.

Enterprise-Grade Security

The DGE-1000 employs enterprise-grade networking with robust security features such as 802.1X authentication, TLS encryption, HTTPS connectivity, and Active Directory® service integration. These

features help to protect your network and to ensure compliance with your organization's network policies. Cloud-based provisioning and management streamlines the process of configuring, monitoring, and updating each DGE-1000 on the network. Additional support for SNMP allows the DGE-1000 to be monitored by your IT administrator.

XiO Cloud® Service

The DGE-1000 is compatible with the XiO Cloud® service, which is an IoT (Internet of Things) based platform for remotely provisioning, monitoring, and managing Crestron devices across an enterprise or an entire client base. Built on the Microsoft® Azure® software platform and utilizing Microsoft's industry-leading Azure IoT Hub technology, XiO Cloud enables installers and IT managers to deploy and manage thousands of devices simultaneously. Unlike other virtual machine-based cloud solutions, Azure services provide unlimited scalability to suit the ever-growing needs of an enterprise. For more information, visit www.crestron.com/xiocloud.

Notes:

1. The DGE-1000 supports up to two simultaneous streaming inputs with a maximum combined total bitrate of 25 Mbps.
2. The HDMI® input signal cannot be downscaled more than 4 times. For instance, a 1920x1080 source signal can be displayed no smaller than 480x270 pixels.
3. Web browsing, weather information, and certain other functions require an internet connection.
4. HDMI connections require an appropriate adapter or interface cable to accommodate a DVI or Dual-Mode DisplayPort™ signal. [CBL-HD-DVI](#) interface cables are available separately.
5. The output resolution is with or without reduced blanking.
6. The output resolution is with reduced blanking only.

Specifications

Product specifications for the DGE-1000.

Product Specifications

Graphics Engine

Crestron HTML5 technology, landscape or portrait orientation, local and remote annotation, multilanguage web browser³, multilanguage onscreen keyboard, screensaver, scalable dual streaming video windowing, displays any combination of HDMI[®] and streaming sources^{1,2}, setup and diagnostics via web browser, onscreen UI, or cloud

Languages

Onscreen Keyboard	Arabic, Chinese (Simplified), Croatian, Czech, Danish, Dutch, English (UK), English (US), Finnish, French (Canada), French (Switzerland), German, Hebrew, Hungarian, Italian, Japanese, Norwegian Bokmal, Polish, Portuguese, Russian, Serbian, Spanish, Swedish, Turkish
Web Browser	Arabic, Chinese (Simplified), Chinese (Traditional), Czech, Danish, Dutch, English (US), Finnish, French, German, Greek, Hebrew, Hungarian, Italian, Japanese, Korean, Norwegian, Polish, Portuguese, Portuguese (Brasil), Romanian, Russian, Slovak, Spanish, Swedish, Thai

Communications

Ethernet	100/1000 Mbps, auto-switching, autonegotiating, autodiscovery, full/half duplex, TCP/IP, UDP/IP, DHCP, SSL, TLS ⁵ , SSH, SFTP (SSH File Transfer Protocol), IEEE 802.1x, Active Directory authentication, HTTPS web browser setup and XiO Cloud service, 802.3af compliant
USB Host	USB 2.0 and 3.0, Supports TSD-2220 touch screen display and most third-party USB HID compliant peripherals
USB Device	For computer console (installer setup and firmware updates)
RS-232	2-way device control and monitoring up to 115.2k baud with hardware and software handshaking (via control system)
IR/Serial	1-way device control via infrared up to 1.1 MHz or serial TTL/RS-232 (0-5V) up to 19200 baud (via control system)
HDMI (Input)	HDCP 1.4, EDID; Supports management of HDCP and EDID
HDMI (Output)	HDCP 2.2, EDID, CEC; Supports management of HDCP and EDID

Pointing Device Support

Compatible with the TSD-2220 touch screen display and most third-party USB HID compliant touch screens, mice, and keyboards

Streaming Decoder

Video Formats	H.264 and H.265 (MPEG-4 part 10 AVC, MJPEG)
Audio Formats	AAC stereo
Bitrates	Up to 20 Mbps
Resolutions	Up to 1080p30

Video

Input Signal Types	HDMI (DVI and dual-mode DisplayPort™ signal compatible ⁴)
Output Signal Types	HDMI (DVI compatible ⁴)
Maximum Input Resolutions	HDMI Input: 1920x1080@60Hz (HD 1080p60);

NOTE: Interlaced video is not supported. All video inputs will be scaled to the selected HDMI.

HDMI Output Resolutions	1280x720@50Hz (720p50), 1280x720@60Hz (720p60), 1280x800@60Hz ⁵ , 1366x768@60Hz ⁵ , 1440x900@60Hz ⁵ , 1600x900@60Hz ⁶ , 1600x1200@60Hz, 1680x1050@60Hz ⁵ , 1920x1080@50Hz (1080p50), 1920x1080@60Hz (1080p60), 3840x2160@30Hz(2160p30) 3840x2160@50Hz(2160p50) 3840x2160@60Hz(2160p)
-------------------------	---

NOTE: All video inputs are scaled to the selected HDMI output resolution.

Audio

Input Signal Types	HDMI (dual-mode DisplayPort compatible ⁴)
Output Signal Types	HDMI
Input/Output Format	2 channel LPCM

Connectors and Card Slots

IR	(1) 2-pin 3.5 mm detachable terminal block; IR/Serial output port for display device control; IR output up to 1.1 MHz; 1-way serial TTL/RS-232 (0-5V) up to 19200 baud
----	--

NOTE: IR port 2 is not used. IRP2 emitter is sold separately.

COM	(1) 5-pin 3.5 mm detachable terminal block; Bidirectional RS-232 port for display device control; Up to 115.2k baud, hardware and software handshaking support
AUDIO OUT	(1) 5-pin 3.5 mm detachable terminal block; Balanced/unbalanced stereo line-level audio output; Maximum Output Level: 4 Vrms balanced, 2 Vrms unbalanced; Output Impedance: 200 ohms balanced, 100 ohms unbalanced
HDMI Input	(1) HDMI Type A connector; HDMI digital video/audio input; (DVI & Dual-Mode DisplayPort compatible)
HDMI Output	(1) HDMI Type A connector; HDMI digital video/audio output (DVI compatible ²)
USB	(2) USB Type A connectors; USB 2.0 host port for USB conferencing peripheral; USB 3.0 host port for USB conferencing peripheral; (1) USB Type B connector; USB 3.0 device port for computer console
LAN PoE+	(1) 8-pin RJ-45 connector; 100Base-TX/1000Base-T Ethernet port and PoE+ Class 4

24 V 1.25A (1) 2.1 x 5.5 mm DC power connector; 24VDC power input; [PW-2412WU](#) power pack sold separately

Controls and Indicators

PWR	(1) Green LED, indicates operating power supplied via the local power pack or PoE+
RESET	(1) Recessed push button for hardware reset
SETUP	(1) Red LED and (1) recessed push button for onscreen IP address display
ONLINE	(1) Green LED, indicates control system connection
HDMI IN/OUT	(2) Green LEDs, indicate HDMI signal presence at the HDMI input/output
LAN PoE+	(2) LEDs, green LED indicates Ethernet link status, amber LED indicates Ethernet activity

Power

Power over Ethernet	IEEE 802.3af Class 4 Powered Device
Power Pack (Sold Separately)	Input: 100-240VAC, 50/60 Hz; Output: 1.25A @ 24VDC; Model: PW-2412WU
Power Consumption	14 W (typical)

Environmental

Temperature	32° to 104°F (-0° to 40° C)
Humidity	10% to 90% RH (non-condensing)
Heat Dissipation	47.8 BTU/hr

Construction

Chassis	Metal, black finish, with (2) integral mounting flanges, vented sides
Mounting	Freestanding, surface mount, or attach to a single rack rail

Dimensions

Height	1.26 in. (33 mm)
Width	7.40 in. (188 mm)
Depth	6.54 in. (166 mm)

Weight

1.9 lb (0.86 kg)

Compliance

Regulatory Model: M202011001

Notes:

1. The DGE-1000 supports up to two simultaneous streaming inputs with a maximum combined total bitrate of 25 Mbps.
2. The HDMI® input signal cannot be downscaled more than 4 times. For instance, a 1920x1080 source signal can be displayed no smaller than 480x270 pixels.
3. Web browsing, weather information, and certain other functions require an internet connection.
4. HDMI connections require an appropriate adapter or interface cable to accommodate a DVI or Dual-Mode DisplayPort™ signal. [CBL-HD-DVI](#) interface cables are available separately.
5. The output resolution is with or without reduced blanking.
6. The output resolution is with reduced blanking only.

Dimension Drawings

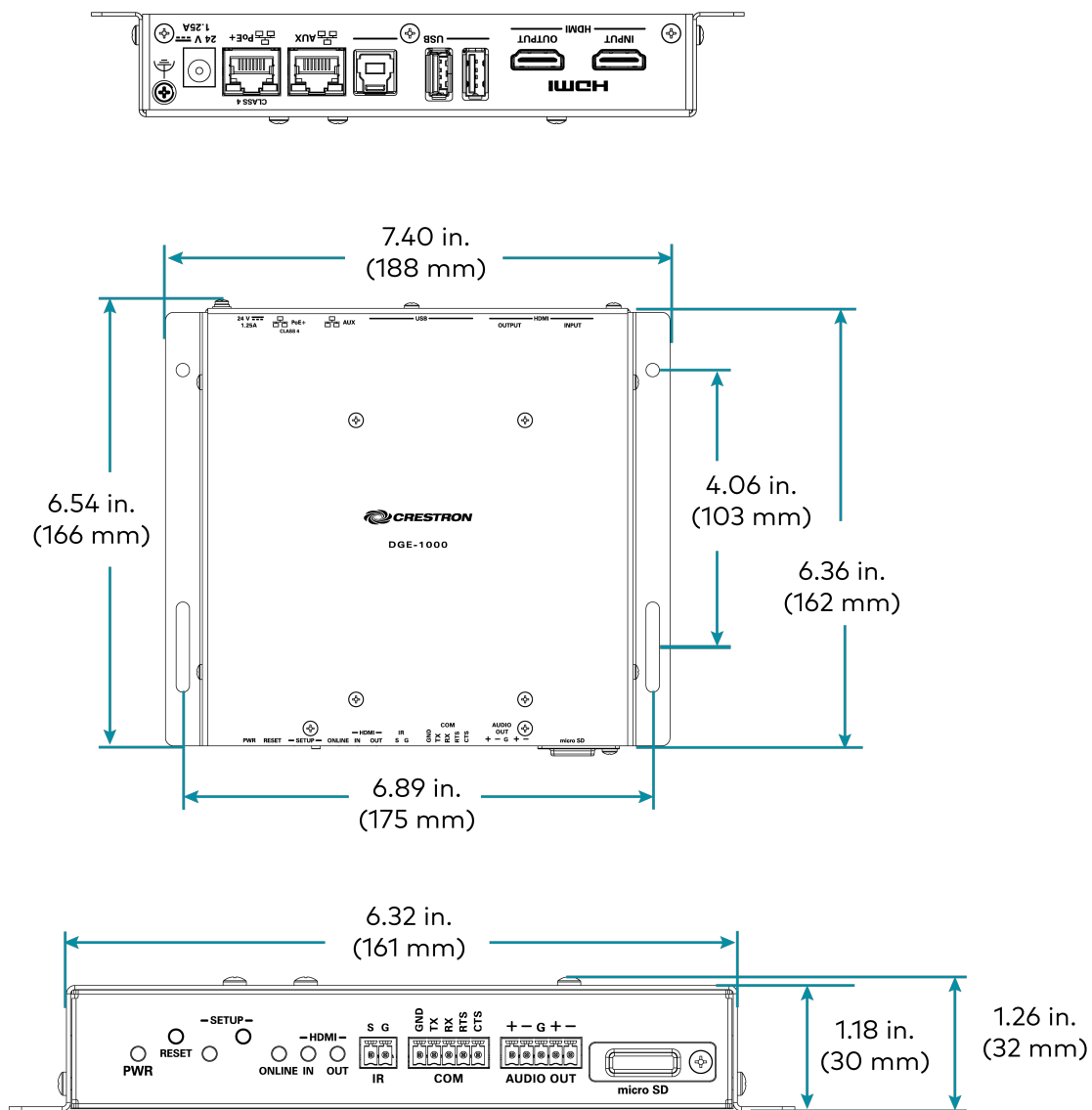

Installation

In the Box

Qty.	Description
1	DGE-1000, Digital Graphics Engine 1000

Additional Items

4	Anchor, Wall, Plastic (2057414)
4	Screw, Metal, Black (2057420)
1	Connector, 2-Pin (2057409)
2	Connector, 5-Pin (2057410)

Installation

The device can be mounted onto a rack rail or flat surface.

Mount onto a Rack Rail

The device can be mounted onto a front or rear rack rail. To mount the device:

1. Position either the left or right mounting flange so that the holes align with the holes in the rack rail.
2. Secure the device to the rack rail using two rack mount screws (not included).

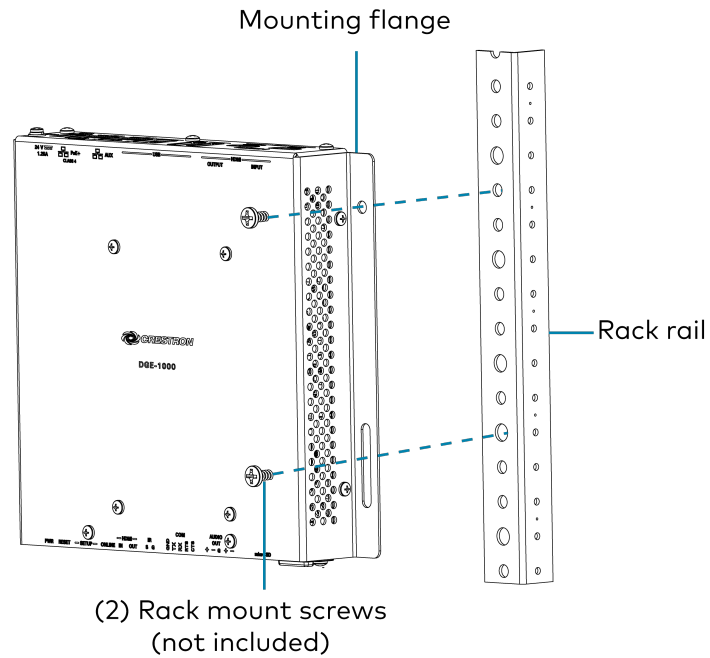

Mount onto a Flat Surface

Using the included mounting screws and anchors, mount the device onto a flat surface such as a wall or the underside of a table. Use the mounting dimensions below to determine the mounting hole locations.

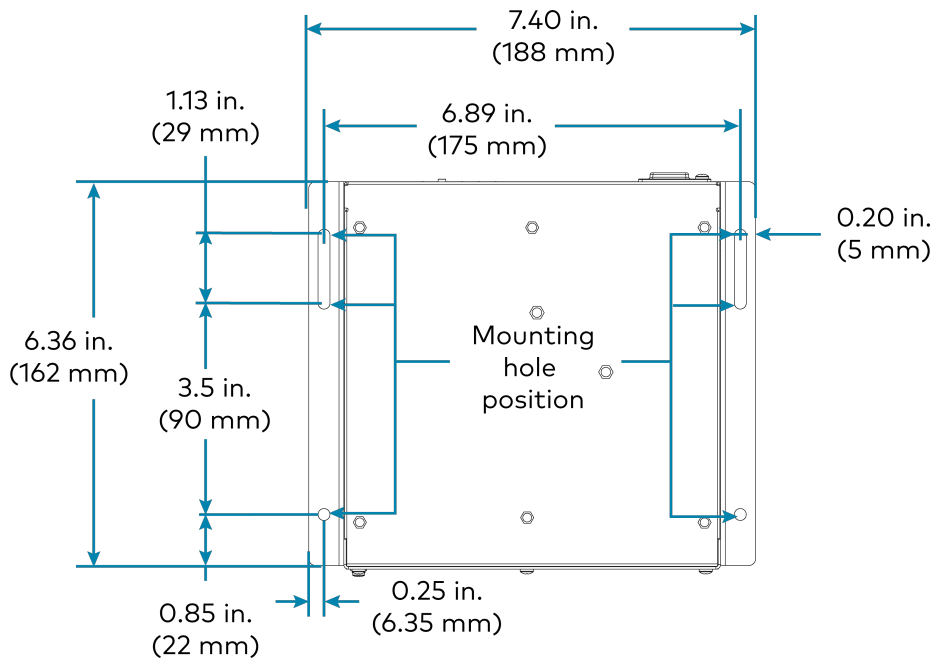
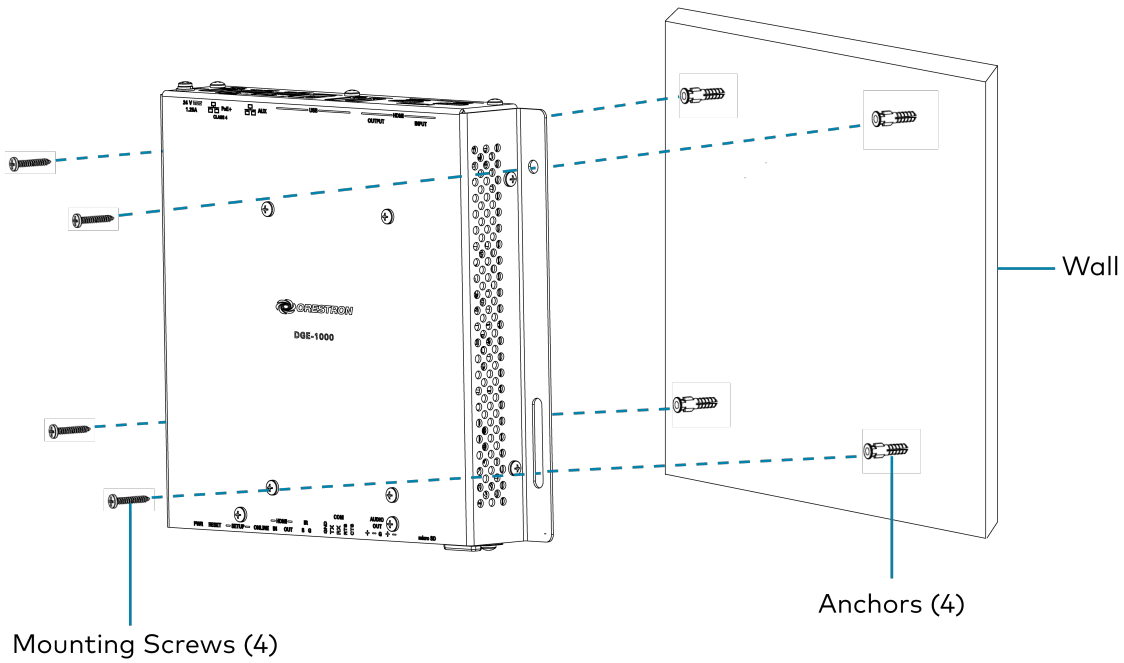

Connections

Top Panel Connections:

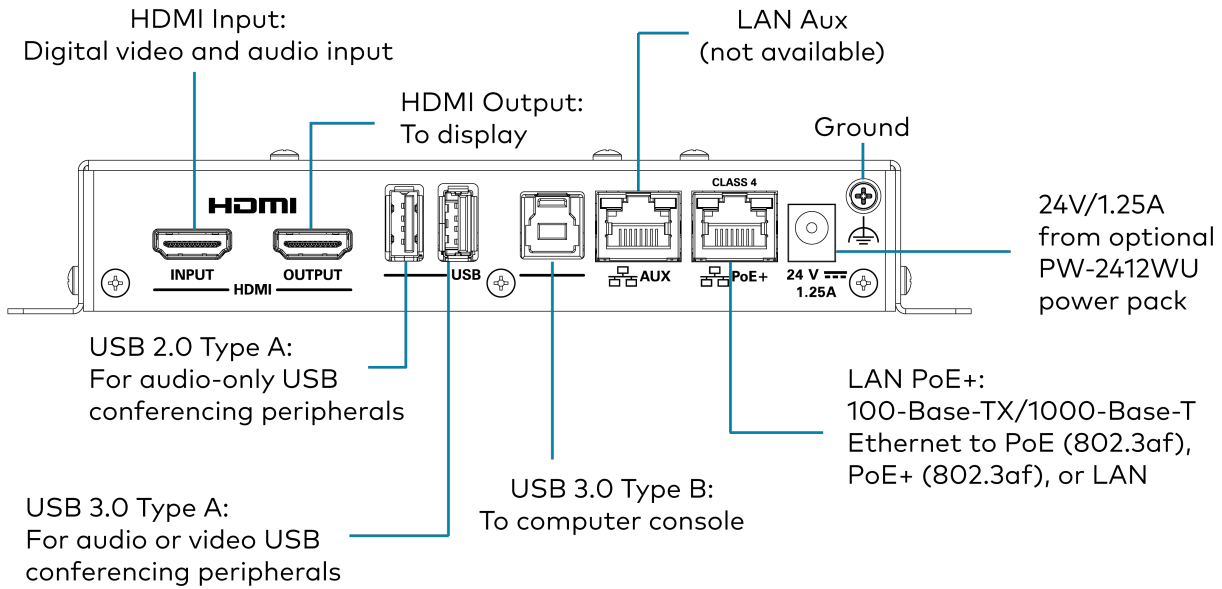

Bottom Panel Connections

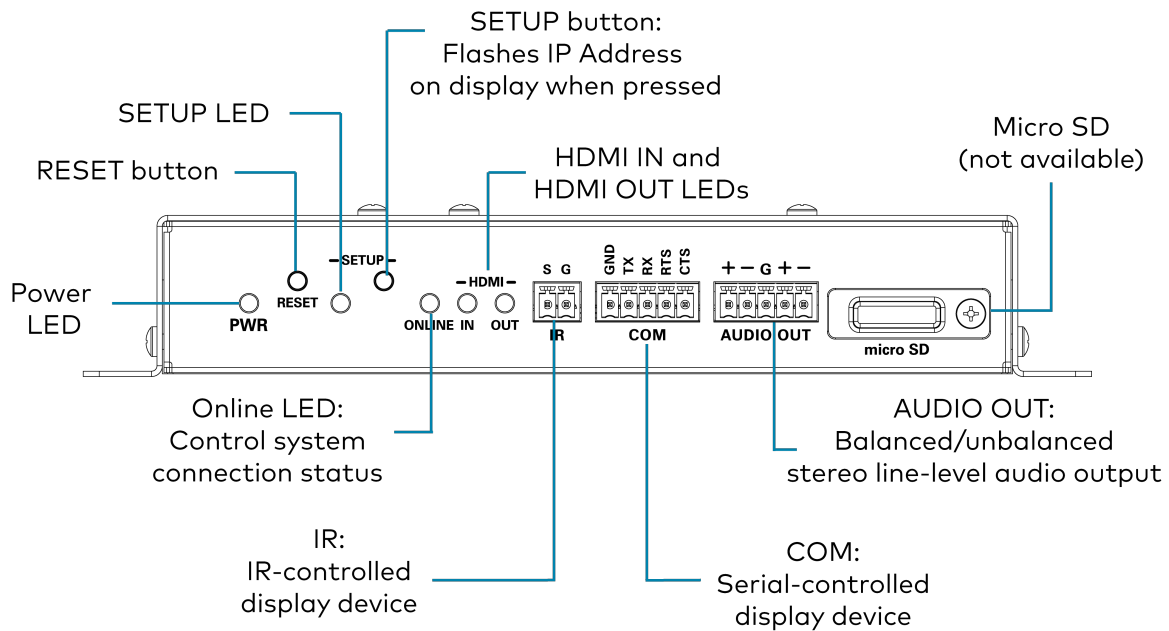

Observe the LEDs

Refer to the following table for information about the LED indicators on the device.

LED Indicator	Color	Meaning
Power	Green	Power is applied to the device. The device is operational.
	Amber	Power is applied to the device. The device is booting.
Setup	White	The setup button was pressed.
Online	Green	The device is connected to a Crestron Control System.
HDMI Input	Green	A video signal is detected at the HDMI input.
HDMI Output	Green	A video signal is transmitted to the HDMI output.
LAN PoE+	Green	An Ethernet link is established.
	Flashing amber	Data activity is occurring on the Ethernet link.

Configuration

Prior to configuration, ensure the device is running the latest firmware. To update the firmware, refer to [Update Firmware on page 19](#).

This section provides the following information:

- [Web Configuration](#)

Web Configuration

The DGE-1000 is configured using the web configuration interface. The web configuration interface is accessible from a web browser. The web configuration interface is also accessible through [XiO® Cloud Service](#).

NOTE: The device has to be connected with a network to access the web UI.

To access the web configuration interface:

1. Connect the device to the same network as the host computer.
2. Use the **Device Discovery tool** in the **Crestron Toolbox™** software to discover the device and its IP address on the network.
3. Open a web browser.
4. Copy the device IP address from the toolbox and paste it into the browser URL field.

NOTE: If you are creating a user account for the first time, follow step 5. If you are an existing user, follow step 6.

5. Create a user account following the steps below:
 - a. Enter a username in the **Username** field.
 - b. Enter a password in the **Password** field. Re-enter the same password in the **Confirm Password** field.

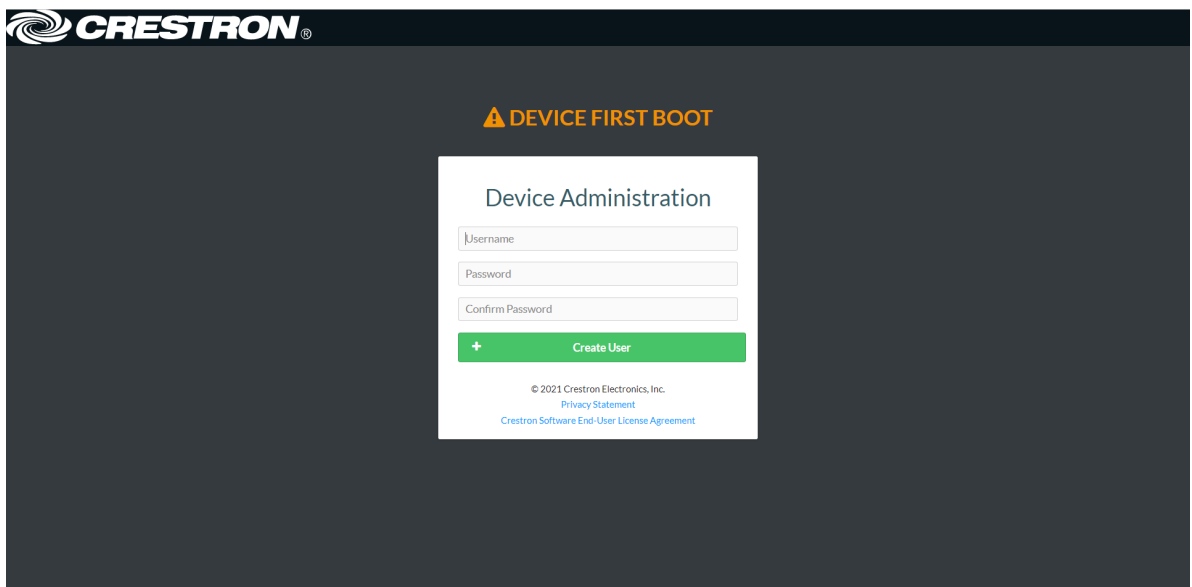

- c. Click **Create User**. The Device Administration page appears.

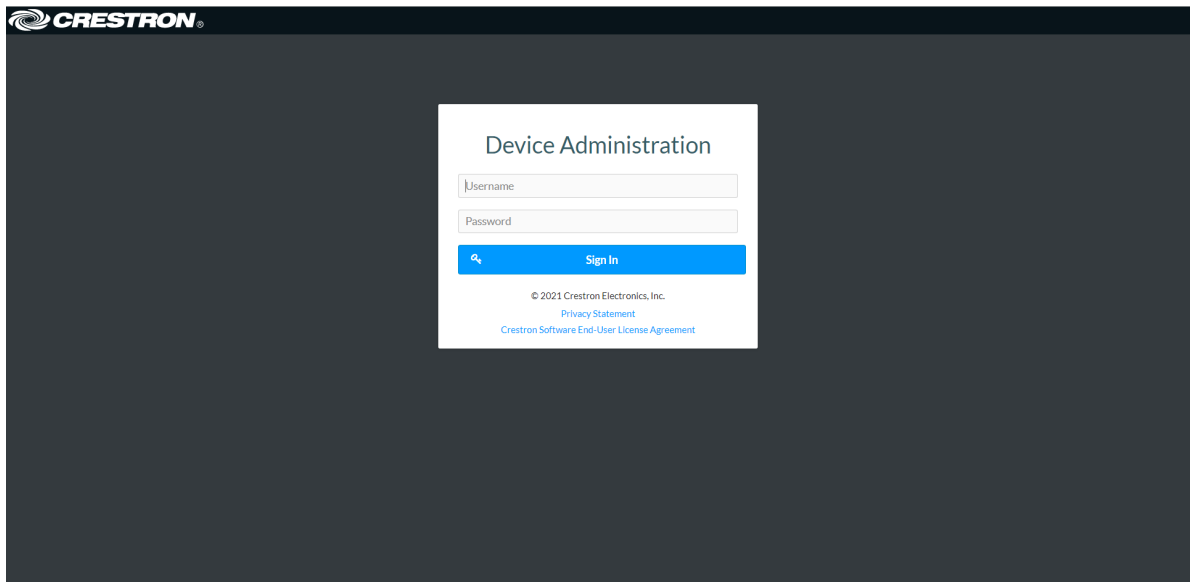

6. Enter the username and password in their respective fields and select **Sign In** to continue. The web user interface is displayed.

Web User Interface

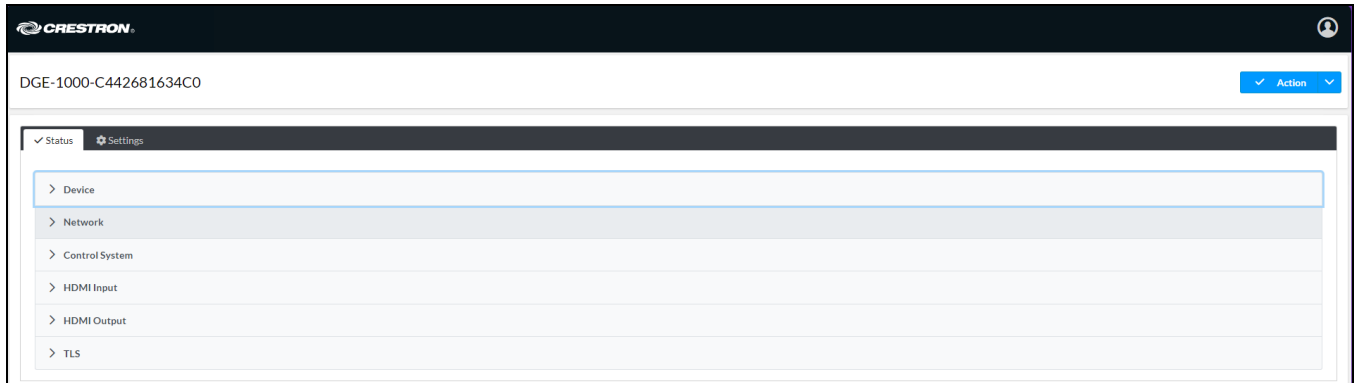

The web configuration interface displays the following :

- **Status:** Used to monitor device status
- **Settings:** Used to configure the settings
- **Action:** Used to access common device functions

Action

The **Action** drop-down menu is displayed at the top right side of the interface and provides quick access to common device functions, such as:

- Save Changes
- Revert
- Update Firmware
- Restore
- Reboot
- Download Logs
- Manage EDIDs
- Manage Certificates
- Enter Setup
- Enter Standby
- Upload User Project
- App Upgrade

Action Menu

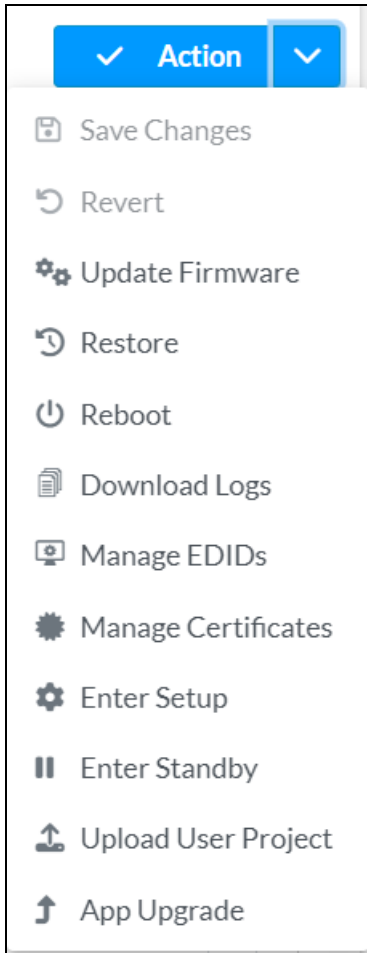

Once any changes have been made to the device configuration, the **Action** button changes to a **Save Changes** button. Select **Save Changes** to save the changes done to the configuration settings.

The **Action** menu provides the following selections:

Save Changes

Select **Save Changes** to save any changes made to the configuration settings.

Revert

Select **Revert** to revert the device back to the last saved configuration settings.

Update Firmware

Select **Update Firmware** to upgrade DGE-1000 firmware manually with a downloaded PUF (package update file).

To update the device firmware PUF through the web user interface:

1. Visit the appropriate device product page or www.crestron.com/Support/Resource-Library to download the latest firmware PUF.
2. Select **Update Firmware**. The **Update Firmware** dialog box is displayed.
3. Select **Browse**, and then navigate to the firmware PUF on the host computer.
4. Select the firmware PUF, and then select **Open**.
5. Select **Load** to load the PUF to the device. The upload progress is shown in the dialog box.
6. Once the device completes the firmware upgrade, select **OK**.

Select the **x** button to close the **Update Firmware** dialog box at any time during the upgrade process. Selecting the **x** button before the PUF is uploaded to the device cancels the upgrade.

Update Firmware Dialog Box

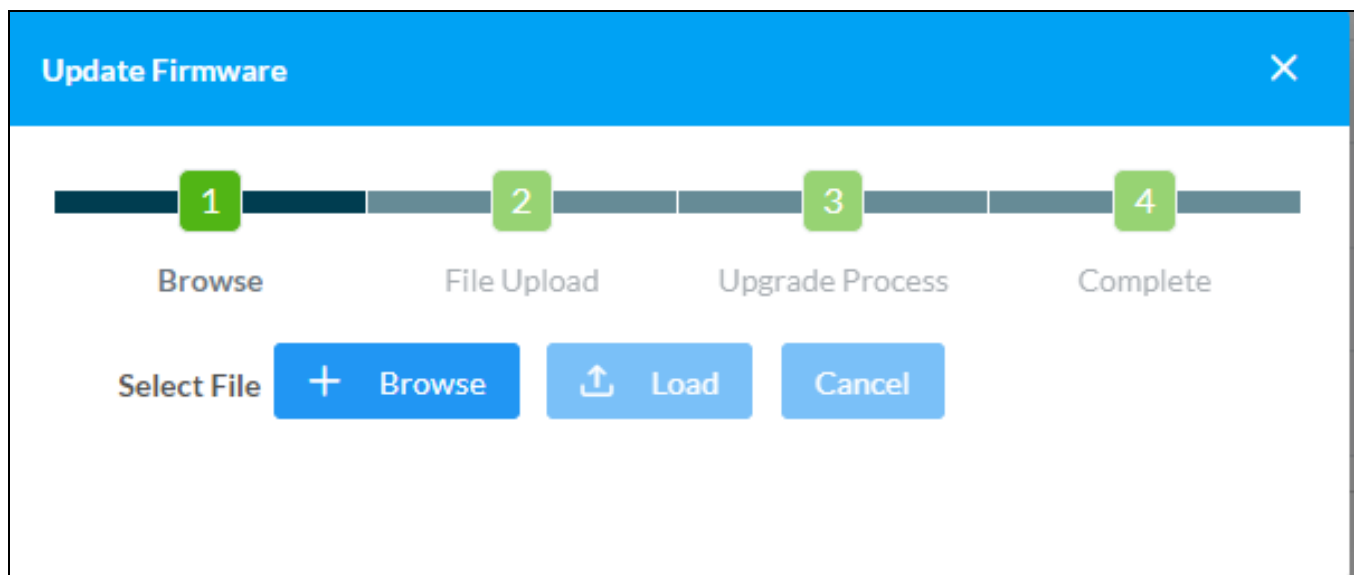

Restore

Select **Restore** to factory restore the device configuration settings. After **Restore** is selected, a dialog box is displayed asking whether the device settings should be restored to factory defaults. Select **Yes** to restore the settings or **No** to cancel the restore.

Reboot

Select **Reboot** to restart the device. After **Reboot** is selected, a dialog box is displayed asking whether the device should be restarted. Select **Yes** to restart the device or **No** to cancel the restart.

Download Logs

Select **Download Logs** to download the device message logs for diagnostic purposes. The message files download as a compressed .tgz file. Once the compressed file is downloaded, extract the message log files to view them.

Manage EDIDs

Select **Manage EDIDs** to manage Extended Display Identification Data (EDID) profiles that are installed in the device. The **Manage EDIDs** window opens.

Default EDIDs

Select **Default EDIDs** to view the EDIDs preinstalled in the device.

Manage EDIDs - Default EDIDs

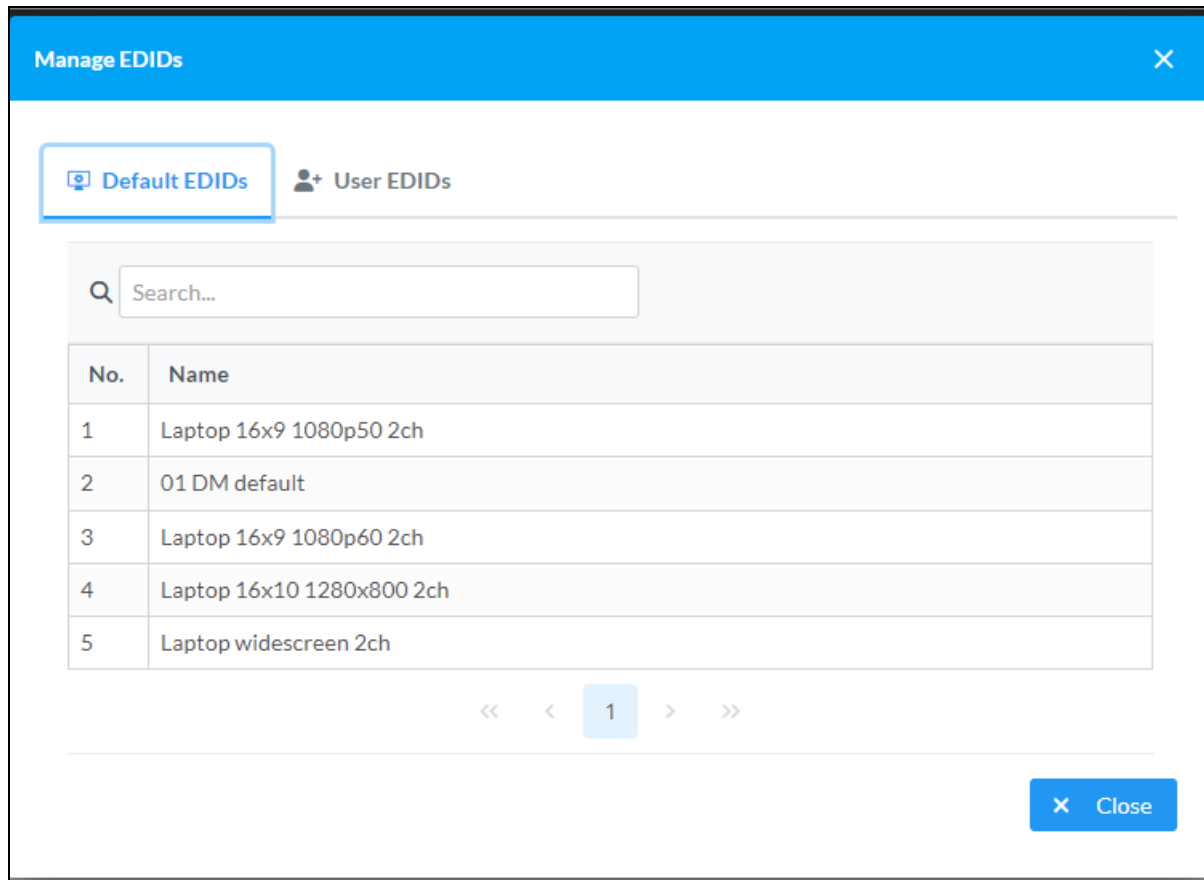

The screenshot shows a window titled "Manage EDIDs" with a blue header and a close button (X) in the top right corner. Below the header, there are two tabs: "Default EDIDs" (selected) and "User EDIDs". A search bar with a magnifying glass icon and the text "Search..." is positioned above a table. The table has two columns: "No." and "Name". It contains five rows of data. Below the table, there are navigation arrows: a double left arrow, a single left arrow, a page number "1" in a light blue box, a single right arrow, and a double right arrow. In the bottom right corner of the window, there is a blue button with a white "X" icon and the text "Close".

No.	Name
1	Laptop 16x9 1080p50 2ch
2	01 DM default
3	Laptop 16x9 1080p60 2ch
4	Laptop 16x10 1280x800 2ch
5	Laptop widescreen 2ch

- Enter text in the **Search...** field to find and display EDIDs that match the search term(s). EDIDs are listed in table format. If the EDIDs span multiple pages, use the navigation arrows on the bottom of the page to move forward or backward through the pages, or select a page number to navigate to that page.
- Select **Close** to close the **Manage EDIDs** window.

User EDIDs

Select **User EDIDs** to manage EDIDs installed by users.

Manage EDIDs - User EDIDs

No.	Name	Actions
No records found		

Enter text in the **Search...** field to find and display EDIDs that match the search term(s). EDIDs are listed in table format. If the EDIDs span multiple pages, use the navigation arrows on the bottom of the page to move forward or backward through the pages, or select a page number to navigate to that page.

Select **Add EDID** to upload a EDID file. The **File Upload** dialog box displays.

File Upload Dialog Box

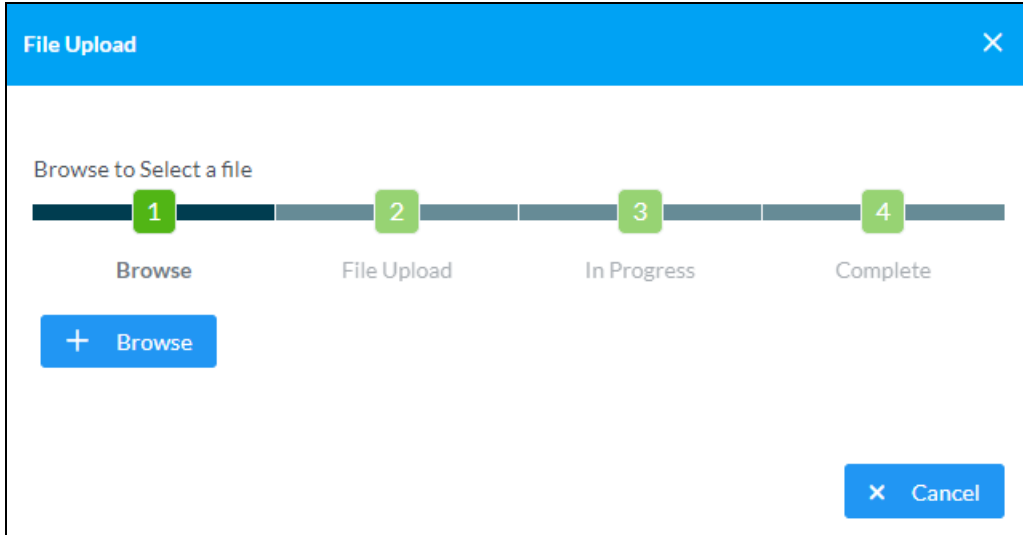

To upload an EDID file:

1. Select **Browse**.
2. Navigate to the EDID file on the host computer.
3. Select the EDID file, and then select **Open**.
4. Select **Load** to load the EDID file to the device. The upload progress is shown in the dialog box.
5. Once the device completes the upload, select **OK**.

Select the **x** button to close the **File Upload** dialog box at any time during the upload process. Selecting the **x** button before the file is uploaded to the device cancels the uploading.

Select **Cancel** to cancel the **Manage EDIDs** window.

Manage Certificates

Select **Manage Certificates** to add, remove, and manage certificates used in 802.1x and other protected networks. The following certificate tabs are displayed:

Manage Certificates

Manage Certificates ×

[Root](#) [Intermediate](#) [Machine](#) [Web Server](#) [Client](#)

Search...

Name	Expiry Date	Actions
AAA Certificate Services	Dec 31 23:59:59 2028	
AC RAIZ FNMT-RCM	Jan 1 00:00:00 2030	
AC RAIZ FNMT-RCM SERVIDORES SEGUROS	Dec 20 09:37:33 2043	
ACCVRAIZ1	Dec 31 09:37:37 2030	
Actalis Authentication Root CA	Sep 22 11:22:02 2030	
AffirmTrust Commercial	Dec 31 14:06:06 2030	
AffirmTrust Networking	Dec 31 14:08:24 2030	

<< < 1 2 3 4 5 > >>

[Add Root Certificate](#)

- **Root:** The Root certificate is used to validate the network's authentication server. The device has a variety of Root certificates, self-signed by trusted CAs (Certificate Authorities), and preloaded into the device.
- **Intermediate:** The Intermediate certificates are non-self-signed certificates used to validate the authentication server. The network administrator will provide these certificates if the network does not use self-signed Root certificates.
- **Machine:** The Machine certificate is an encrypted PFX file that is used by the authentication server to validate the device identity. The Machine certificate will be provided by the network administrator, along with the certificate password.
- **Web Server:** The Web Server certificate is a digital file that contains information about the identity of the web server.
- **Client:** The Client certificate tab is to add new client

Search

Type a search term into the **Search...** text field to search for and display CAs that match the search term.

The following information is provided for each type of CA:

- **Name:** The CA name
- **Expiry Date:** The date and time that the CA is set to expire

If the CAs span multiple pages, use the navigation arrows on the bottom of the page to move forward or backward through the pages, or select a page number to navigate to that page.

Add Certificate

Add Certificate Dialog Box

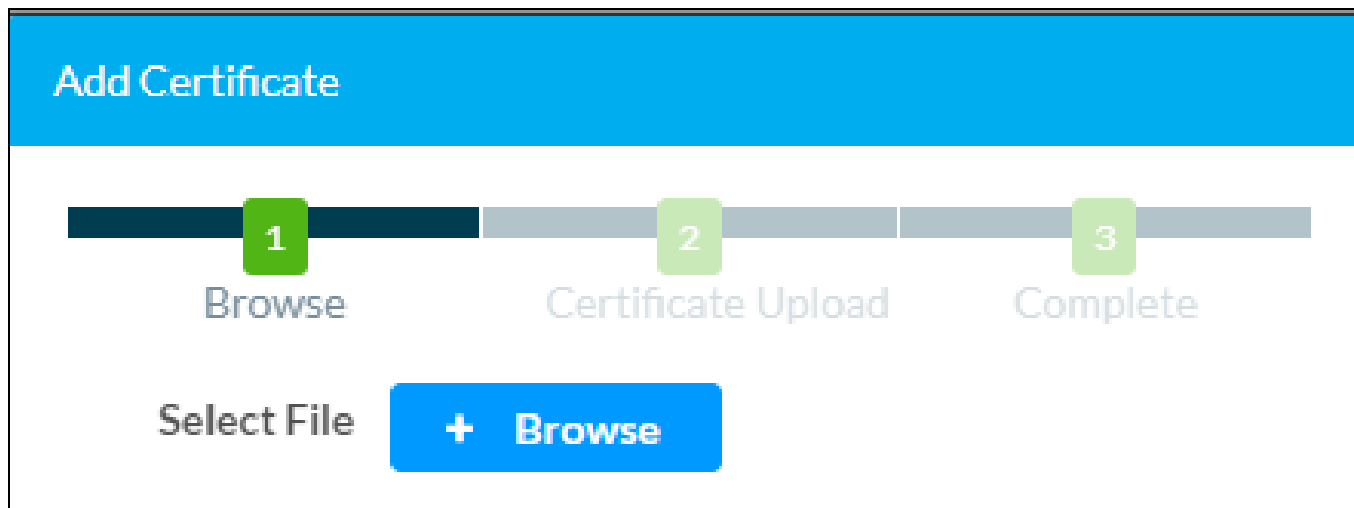

1. Select **Add [Type] Certificate** to add a Certificate Authority (CA) of one of the five available types (**Root, Intermediate, Machine, Web Server** or **Client**) to the list of CAs. The **Add Certificate** pop-up dialog box is displayed.
2. Select the **+ Browse** button.
3. Navigate to the CA file on the host computer.
4. Select the CA file, and then click **Open**.
5. Select **Load** to load the CA file to the device. The upload progress is shown in the dialog box.
6. Once the device has completed the upload, click **OK**.

Delete Certificate

1. Select the corresponding certificate tab.
2. Select the trashcan button  in the **Actions** column to delete the certificate. A pop-up dialog box is displayed asking if the CA should be deleted.
3. Select **Yes** to delete the certificate or **No** to cancel.

Enter Setup

Select **Enter Setup** to force the device to enter its built-in setup interface.

Enter Standby

Select **Enter Standby** to force the device to enter standby mode.

Upload User Project

Select **Upload User Project** to upload a custom user project to the device. A **Project Upload** dialog box opens.

Project Upload Dialog Box

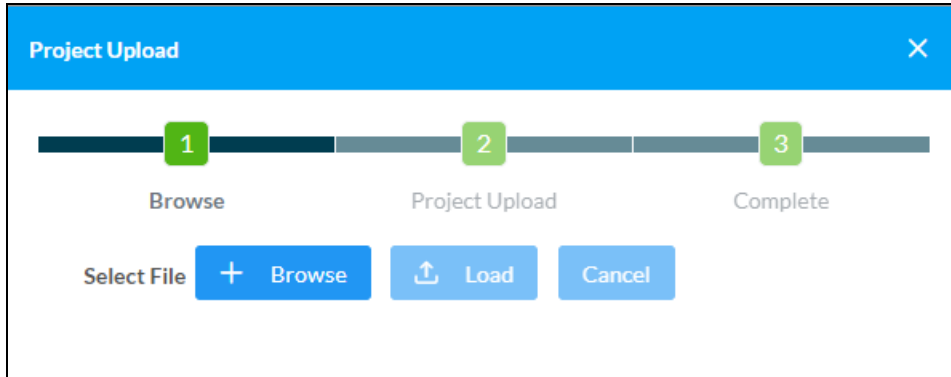

NOTE: This selection is available only if the device is running in user project mode.

To upload a custom user project:

1. Select **Browse**, and then navigate to the project .vtz file on the host computer.
2. Select the project .vtz file, and then select **Open**.
3. Select **Load** to load the project .vtz file to the device. The upload progress is shown in the dialog box.
4. Once the device completes the project upload, select **OK**.

Select the **x** button to close the **Project Upload** dialog box at any time during the upgrade process.

Selecting the **x** button before the project file is uploaded to the device cancels the upload.

App Upgrade

Select **App Upgrade** to update the currently selected application. The update progress is shown in a pop-up window.

Once the update is complete, select **OK** to close the pop-up window.

Status

Select **Status** to display collapsible accordions for viewing the status of the Device, Network, Control System, HDMI Input, HDMI Output and TLS.

Select an accordion name to expand the section. If the section is expanded, select the accordion name again to collapse it.

Status screen

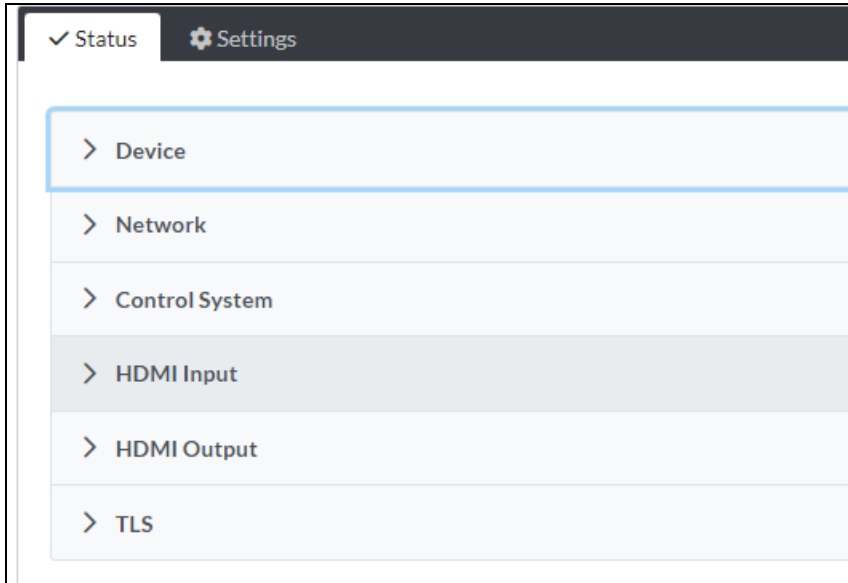

Device

Select **Device** to view general device information.

Status – Device

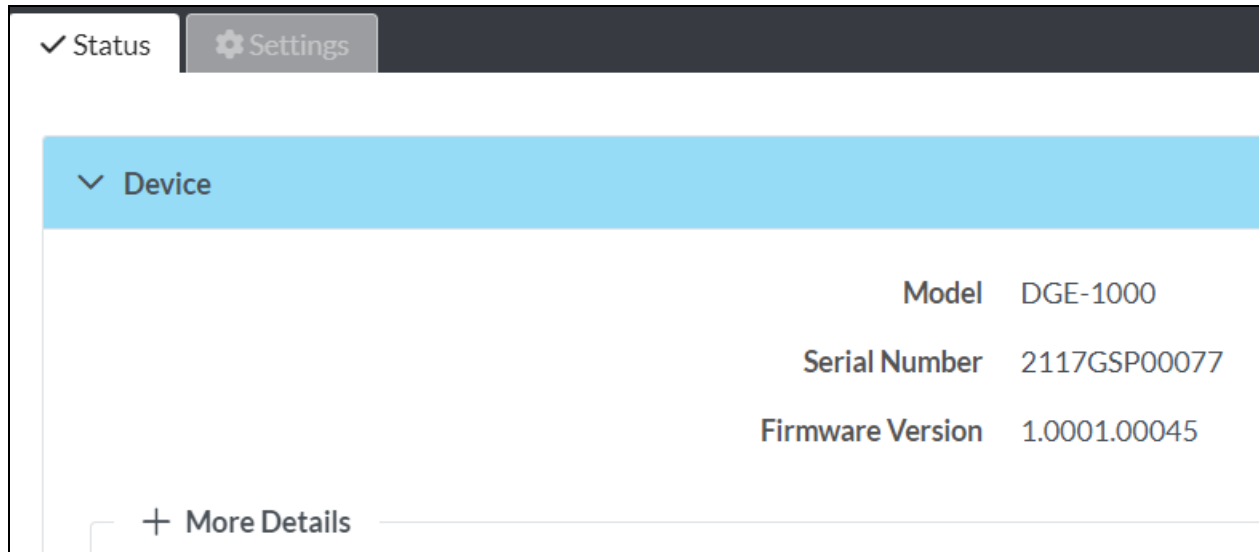

The screenshot shows a web interface with two tabs: 'Status' (selected) and 'Settings'. Below the tabs is a 'Device' section with a blue header and a dropdown arrow. The section contains a table of device information:

Model	DGE-1000
Serial Number	2117GSP00077
Firmware Version	1.0001.00045

At the bottom of the section is a '+ More Details' link.

The following Device information is displayed:

- **Model:** The device model name
- **Serial Number:** The device serial number
- **Firmware Version:** The firmware version loaded onto the device

Select **+More Details** at the bottom of the tab to display an expanded section that shows additional information. Select **- More Details** to collapse the section.

Network

Select **Network** to view the status of the network settings for the device.

Status – Network

Network	
Hostname	DGE-1000-C442681634C0
Domain	localdomain
DNS Servers	49.205.72.130(DHCP),183.82.243.66(DHCP)
— Adapter 1	
DHCP	On
IP Address	192.168.0.101
Subnet Mask	255.255.255.0
Default Gateway	192.168.0.1
Link Active	True
MAC Address	c4.42.68.16.34.c0

The following Network information is displayed:

- **Host Name:** The device hostname
- **Domain:** The device domain name
- **DNS Servers:** The DNS (domain name server) addresses used to resolve the device domain to an IP address

Control System

Select **Control System** to view the status of the device control system connection.

Status – Control System

Control System

Encrypt Connection OFF

IP Table

IP ID	Room Id	IP Address/Hostname	Type	Server Port	Connection	Status
No records found						

The following **Control System** information is displayed:

- **Encrypt Connection:** Indicates whether the connection between the control system and the device is encrypted.
- **IP Table:** Displays the IP table information for the control system connection:
 - **IP ID:** The IP ID used to connect the device to a control system
 - **Room ID:** The control system room ID that the device is associated with (for connections to the Crestron Virtual Control server-based control system)
 - **IP Address/Hostname:** The control system IP address or hostname
 - **Type:** The control system type
 - **Server Port:** The control system server port
 - **Connection:** The control system connection type
 - **Status:** The control system connection status

HDMI Input

Select **HDMI Input** to view the status of a device connected to the HDMI input.

Status – HDMI Input

▼ HDMI Input	
Sync Detected	No
Resolution	0x0@0
Source HDCP	Inactive
— More Details	
HDCP State	Non-HDCP Source
Interlaced	No
Horizontal Resolution	0
Vertical Resolution	0
Frames Per Second	0
Aspect Ratio	No signal
Audio Format	No Audio
Audio Channels	0

The following HDMI Input information is displayed:

- **Sync Detected:** Indicates whether a sync is present between the source connected to the HDMI input and the device.
- **Resolution:** The resolution of the source connected to the HDMI input.
- **Source HDCP:** Indicates whether HDCP is active or inactive.

Select **+ More Details** at the bottom of the tab to display an expanded section that shows additional information. Select **- More Details** to collapse the section.

HDMI Output

Select **HDMI Output** to view the status of a display device connected to the HDMI output.

Status – HDMI Output

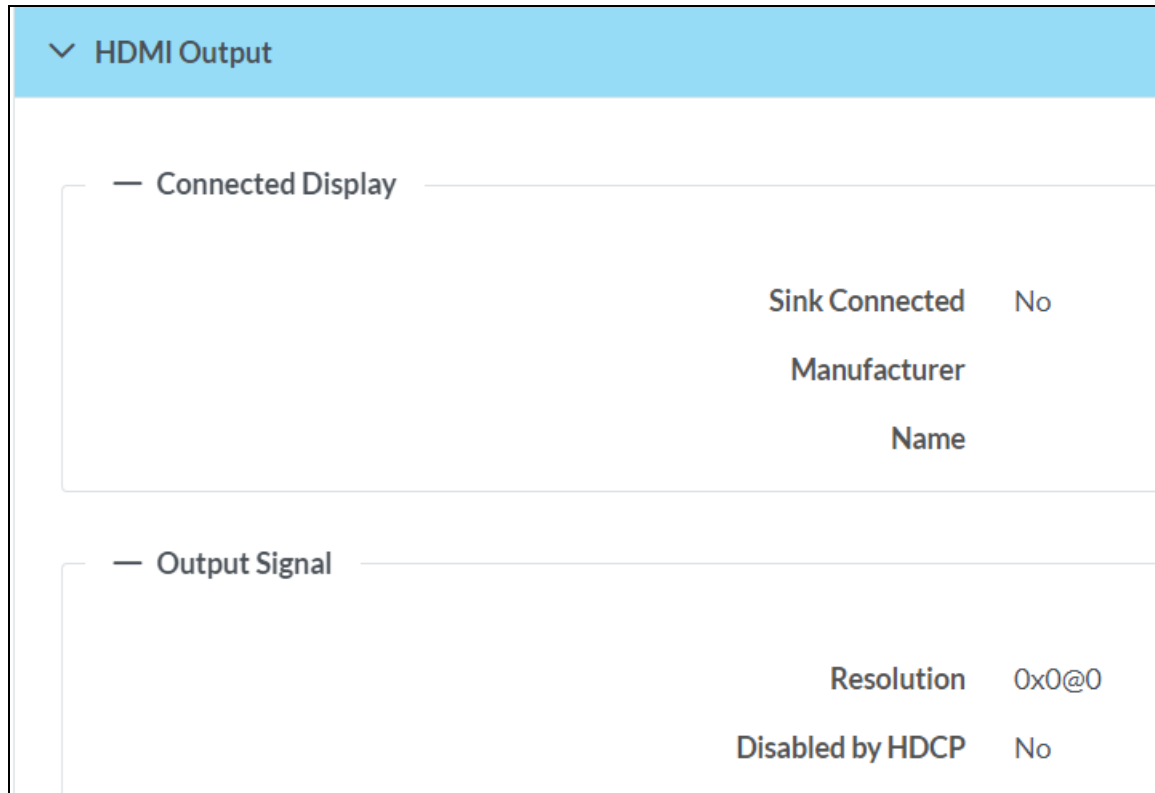

The screenshot shows a user interface for 'HDMI Output' status. It has a light blue header with a dropdown arrow and the text 'HDMI Output'. Below the header, there are two main sections: 'Connected Display' and 'Output Signal'. Each section has a minus sign icon to its left. The 'Connected Display' section contains three rows of data: 'Sink Connected' with the value 'No', 'Manufacturer', and 'Name'. The 'Output Signal' section contains two rows of data: 'Resolution' with the value '0x0@0' and 'Disabled by HDCP' with the value 'No'.

Connected Display	
Sink Connected	No
Manufacturer	
Name	

Output Signal	
Resolution	0x0@0
Disabled by HDCP	No

Select the **+** (plus) icon next to **Connected Display** to view the following display settings:

- **Sink Connected:** Reports whether or not a display is connected
- **Manufacturer:** The manufacturer name of the display device
- **Name:** The name of the display device

Select the **+** (plus) icon next to **Output Signal** to view the following output signal settings:

- **Resolution:** The resolution and frame rate of the display device
- **Disabled by HDCP:** Reports whether or not the display signal is disabled by HDCP

Select **+ More Details** at the bottom of the tab to display an expanded section that shows additional information. Select **- More Details** to collapse the section.

TLS

Select **TLS** to view the status of the **TLS** (Transport Layer Security).

Status - TLS

▼ TLS	
TLS Compatibility	TLS1.2
Disable trust list verification	false
Disable DNS host name verification	false
Disable extended key usage verification	false

The following **TLS** information is displayed:

- **TLS Compatibility:** Displays TLS compatibility status.
- **Disable trust list verification:** If not disabled in the settings, **false** is displayed.
- **Disable DNS host name verification:** If not disabled in the settings, **false** is displayed.
- **Disable extended key usage verification:** If not disabled in the settings, **false** is displayed.

Settings

Select **Settings** to display collapsible accordions for viewing and configuring the System Setup, Auto Update, HDMI Input, HDMI Output, Access Control and TLS settings. Once any changes have been made to the device configuration, the **Action** button becomes a **Save Changes** button. Select **Save Changes** to save changes to the configuration settings. If a reboot is required after changes have been saved, select **Yes** to reboot the device or **No** to cancel the reboot.

Select an accordion name to expand the section. If the section is expanded, select the accordion name again to collapse it.

Settings screen

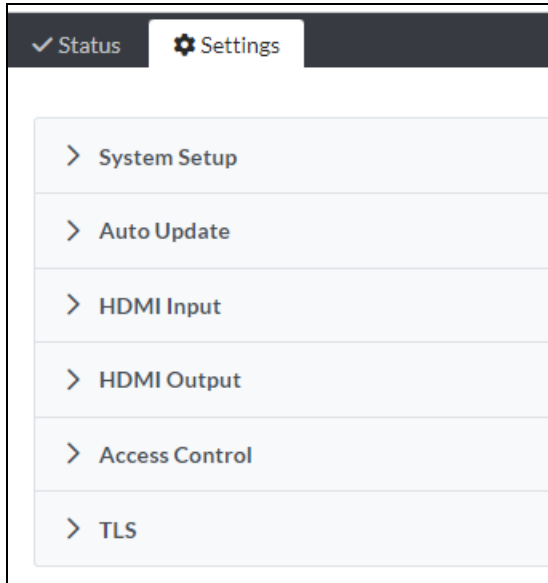

System Setup

Select **System Setup** to modify General Settings, Network, Date/Time, Control System, Cloud Settings, Button Toolbar, Device Display, 802.1x Configuration and Device Audio settings.

Settings - System Setup

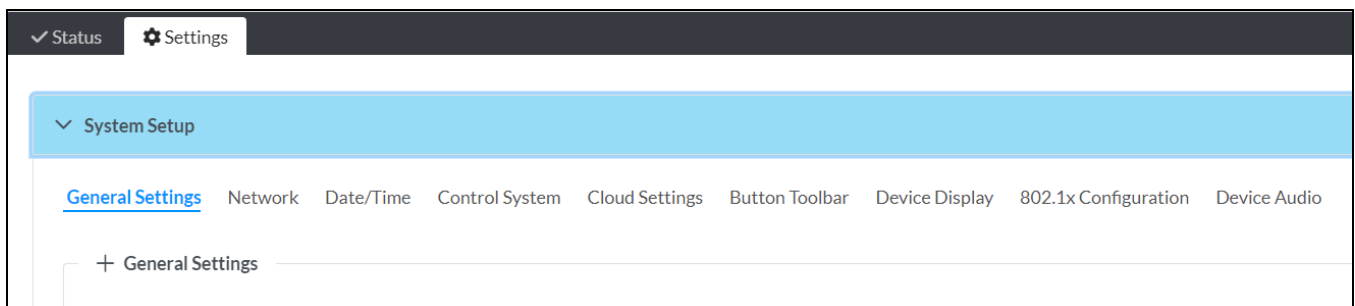

General Settings

Select **General Settings** to configure general device settings.

System Setup – General Settings

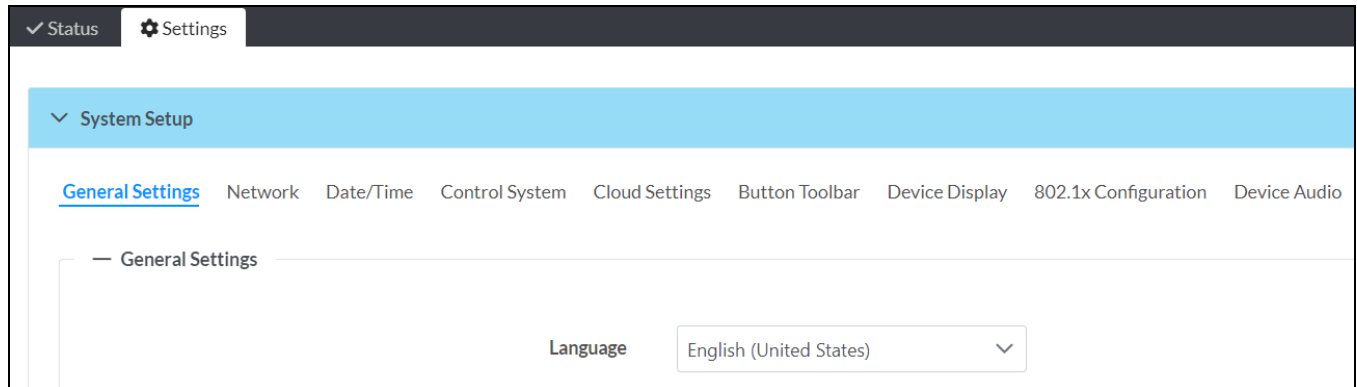

✓ Status Settings

System Setup

[General Settings](#) Network Date/Time Control System Cloud Settings Button Toolbar Device Display 802.1x Configuration Device Audio

— General Settings

Language English (United States) ▾

Language: Select the **Language** from the drop-down list.

Network

Select **Network** to configure the device network settings.

System Setup - Network

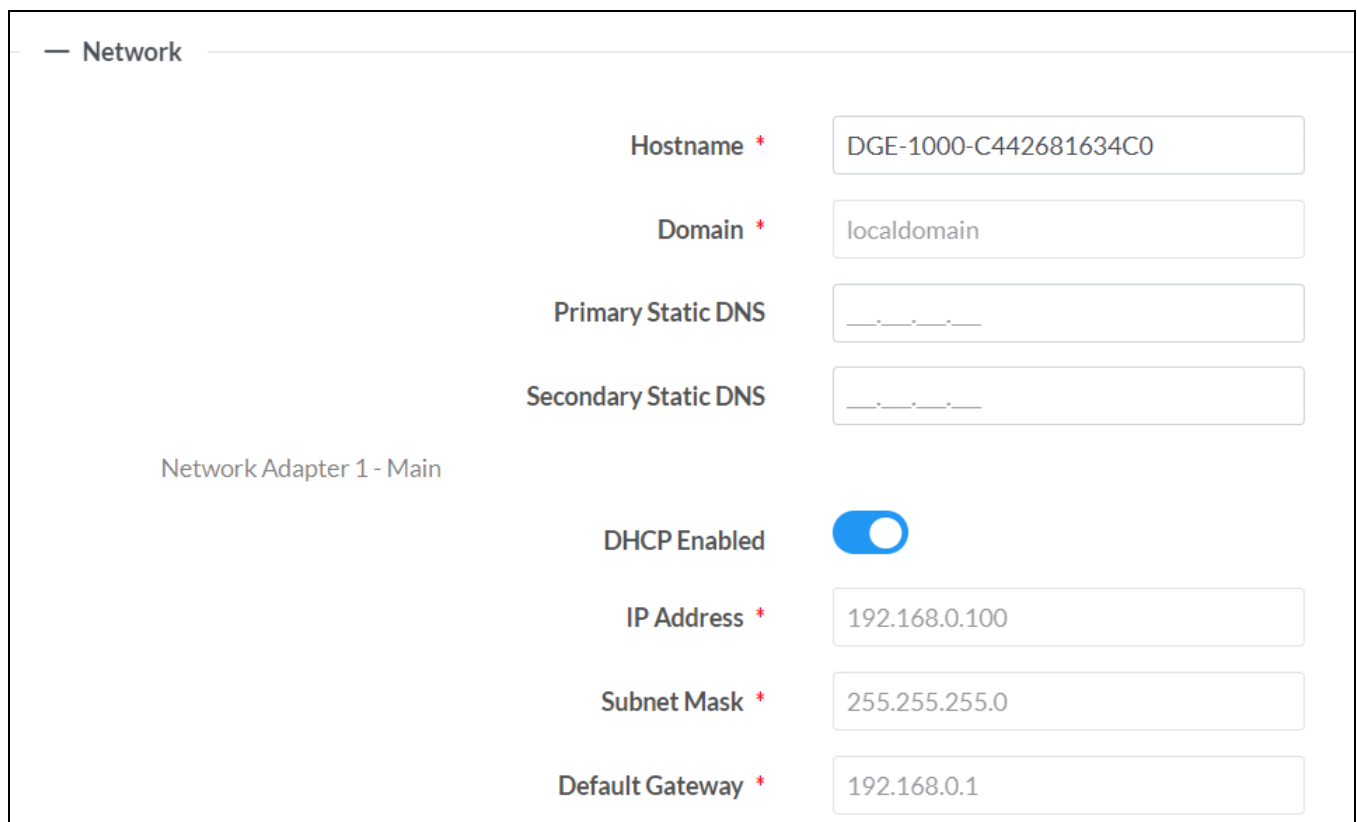

— Network

Hostname * DGE-1000-C442681634C0

Domain * localdomain

Primary Static DNS

Secondary Static DNS

Network Adapter 1 - Main

DHCP Enabled

IP Address * 192.168.0.100

Subnet Mask * 255.255.255.0

Default Gateway * 192.168.0.1

- **Host Name:** Enter the device host name (22 characters or less).
- **Domain:** Enter the fully qualified domain name on the network (optional). This field is prefilled when the DHCP toggle is turned on.

NOTE: A host name and domain name can act as an alternative to the IP address for connecting client computers to the device.

- **Primary Static DNS:** Enter the primary DNS address.
- **Secondary Static DNS:** Enter the secondary DNS address.
- **Network Adapter 1 - Main**
 - **DHCP Enabled:** Turn the toggle on to use DHCP for the Ethernet connection. When enabled, the IP address, subnet mask, and default gateway settings are automatically filled. If the toggle is off, these settings must be entered manually.
 - **IP Address:** Enter the device IP address on the network. This field is prefilled when the DHCP toggle is on.
 - **Subnet Mask:** Enter the device subnet mask address on the network. This field is prefilled when the DHCP toggle is on.
 - **Default Gateway:** Enter the gateway router address on the network. This field is prefilled when the DHCP toggle is on.

System Setup - Network

Network Proxy Settings

Proxy

HTTP Settings

HTTP Proxy

HTTP Proxy Address *

HTTP Proxy Port *

Username

Password

HTTPS Settings

HTTPS Proxy

HTTPS Proxy Address *

HTTPS Proxy Port *

Username

Password

- **Network Proxy Settings**
 - **Proxy:** Turn the toggle on to configure the device for use with a proxy server.
- **HTTP Settings**
 - **HTTP Proxy:** Turn the toggle on to allow the device to use an HTTP proxy server.
 - **HTTP Proxy Address:** Enter the IP address or the FQDN of the HTTP proxy server.
 - **HTTP Proxy Port:** Select the port number of the HTTP proxy server using the drop-down list.
 - **Username:** Enter the username required for the HTTP proxy server.
 - **Password:** Enter the password required for the HTTP proxy server.

- **HTTPS Settings**

- **HTTPS Proxy:** Turn the toggle on to allow the device to use an HTTPS proxy server.
- **HTTPS Proxy Address:** Enter the IP address or the FQDN of the HTTPS proxy server.
- **HTTPS Proxy Port:** Select the port number of the HTTPS proxy server using the drop-down list.
- **Username:** Enter the username required for the HTTPS proxy server.
- **Password:** Enter the password required for the HTTPS proxy server.

Date/Time

Select **Date/Time** to configure the settings for the device internal clock.

System Setup – Date/Time

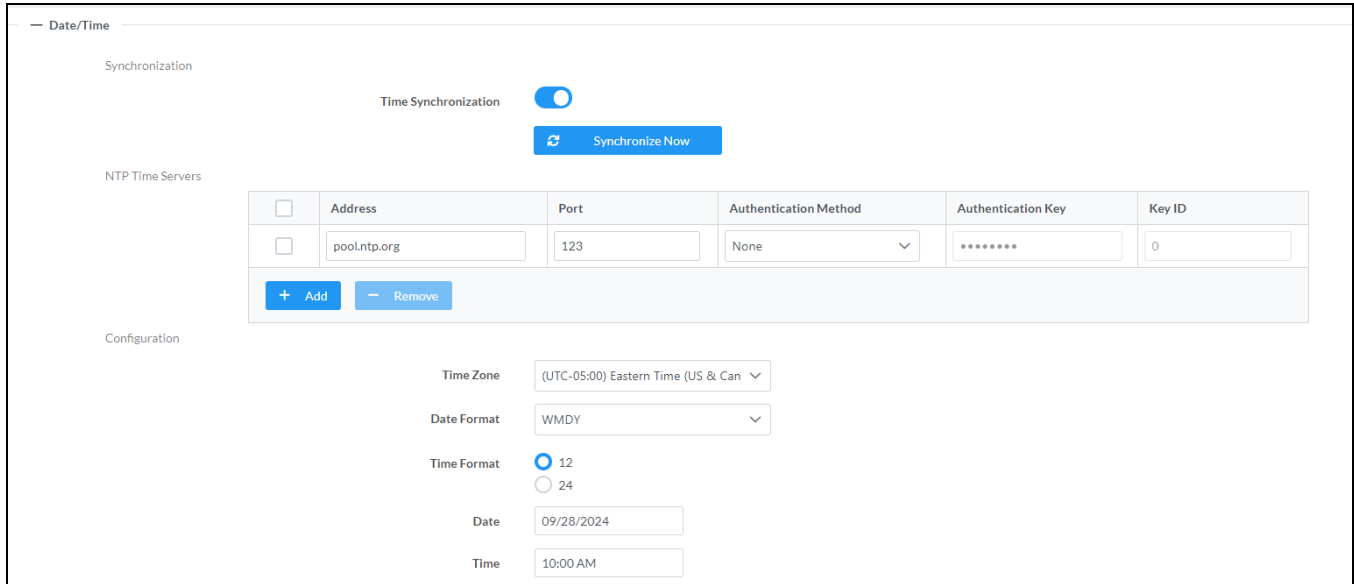

— Date/Time

Synchronization

Time Synchronization

NTP Time Servers

<input type="checkbox"/>	Address	Port	Authentication Method	Authentication Key	Key ID
<input type="checkbox"/>	poolntp.org	123	None	*****	0

Configuration

Time Zone: (UTC-05:00) Eastern Time (US & Can)

Date Format: WMDY

Time Format: 12 24

Date: 09/28/2024

Time: 10:00 AM

- Synchronization: The device internal clock can be synchronized with a time server.
 - **Time Synchronization:** Turn the toggle on to use time synchronization via SNTP (Simple Network Time Protocol).
 - **Synchronize Now:** With **Time Synchronization** turned on, select **Synchronize Now** to synchronize the receiver with the SNTP server(s) entered in the **NTP Time Servers** table.
- **NTP Time Servers:** With Time Synchronization turned on, use the provided table to enter information regarding the SNTP server(s) used to synchronize the date and time for the device.
 - Select **Add** to add a new SNTP server entry into the table.
 - Enter the following information for each entry:
 - Enter the SNTP server address into the **Address** text field.
 - Enter the SNTP server port into the **Port** text field.
 - Use the **Authentication Method** drop-down list to select the authentication method used to access the SNTP server (if one exists).
 - If an authentication method is selected, enter the key used to authenticate against the SNTP server into the **Authentication Key** text field.
 - If an authentication method is selected, enter the ID for the key used to authenticate against the SNTP server into the **Key ID** text field.
 - To remove an entry, fill the checkbox to the left of the table entry, and then select **Remove**.

- **Configuration:** The device internal clock can be configured manually.
 - **Time Zone:** Select a **Time Zone** for the device using the drop-down list.
 - **Date Format:** Select the format that the date will appear on the display device using the drop-down list (MDY, DMY, or YMD).
 - **Time Format:** Select the format that the time will appear on the display device (12 hour or 24 hour).
 - **Date:** Select the date for the device using the pop-up calendar that is displayed.

Control System

Select **Control System** to connect and configure a control system with the device. The device can be controlled by a Crestron control system or by a virtual control system's SIMPL or SIMPL# program.

System Setup – Control System

System Setup

General Settings Network Date/Time **Control System** Cloud Settings Button Toolbar Device Display 802.1x Configuration Device Audio

Control System

Encrypt Connection

Control System Username

Control System Password

IP Table

<input type="checkbox"/>	IP ID	IP Address/Hostname	Room Id
No records found			

+ Add x Remove

- **Encrypt Connection:** Turn the toggle on to use SSL encryption for communication with the control system. SSL can be used with or without a CA certificate. When **Encrypt Connection** is toggled on, the username and password for the control system is required.
 - **Control System Username:** The username for the control system.
 - **Control System Password:** The password for the control system.
- **IP Table:** Select **Add** to add an IP table connection between the device and the control system.
 - **IP ID:** Enter an IP ID for connecting the device to the control system.

NOTES:

- The control system will search the related ID while entering the IP ID.
 - The IP ID must match the IP ID defined in the control system's SIMPLWindows or SIMPL# program.
- **IP Address/Hostname:** Enter the control system IP address or hostname.
 - **Room ID:** Enter a room ID to associate with the device (for connections with the Crestron Virtual Control server-based control system).

Cloud Settings

Select **Cloud Settings** to configure the device's connection to the XiO Cloud® service. By default, the **Cloud Configuration Service Connection** toggle is turned on.

System Setup - Cloud Settings

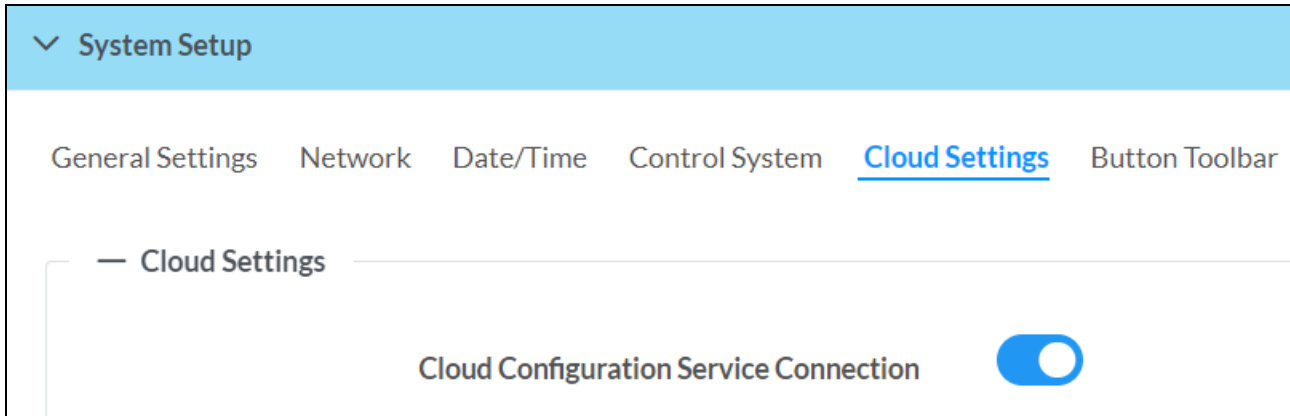

Button Toolbar

Select **Button Toolbar** to display the following virtual toolbar button settings.

System Setup - Button Toolbar

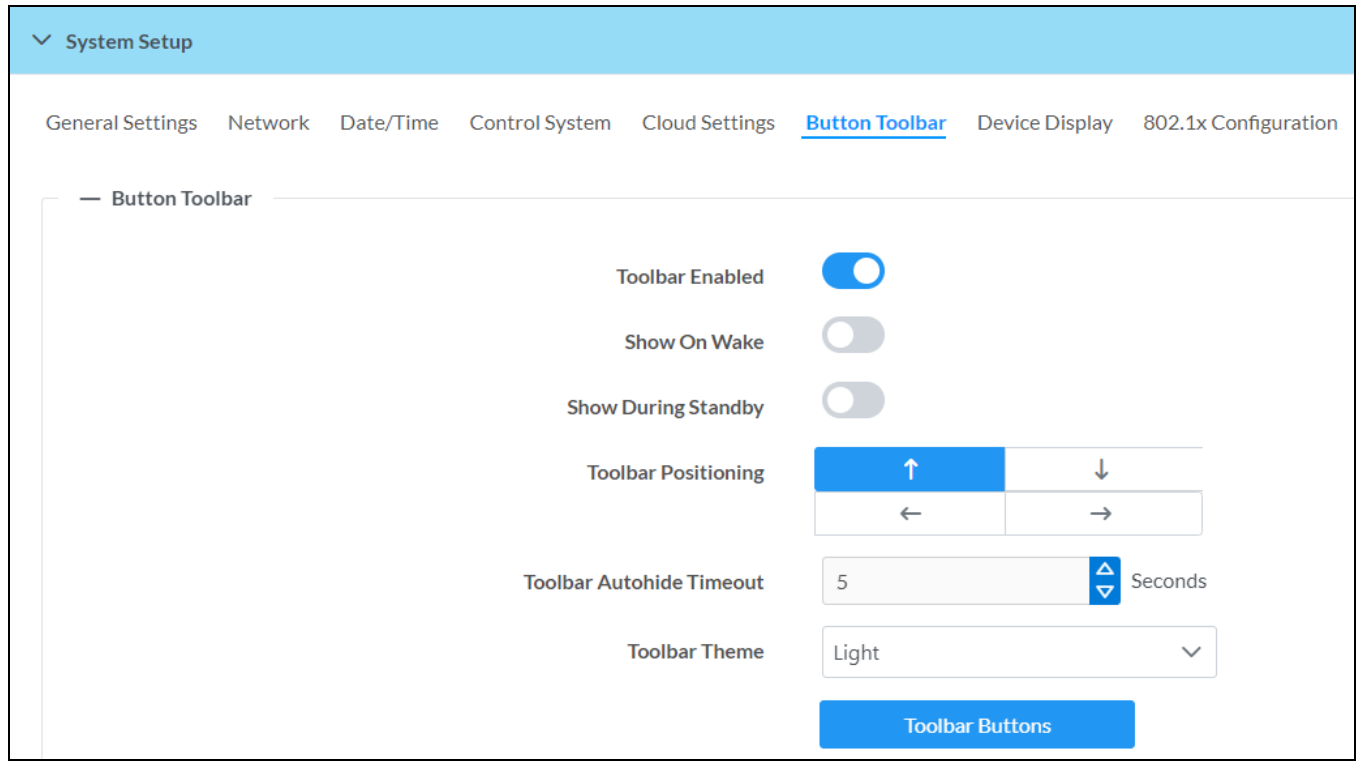

The screenshot shows the 'System Setup' interface with the 'Button Toolbar' section selected. The settings are as follows:

- Toolbar Enabled:** A toggle switch that is turned on (blue).
- Show On Wake:** A toggle switch that is turned off (grey).
- Show During Standby:** A toggle switch that is turned off (grey).
- Toolbar Positioning:** A control with four directional arrows: up, down, left, and right. The up arrow is highlighted in blue.
- Toolbar Autohide Timeout:** A numeric input field set to '5' with a 'Seconds' label and a small up/down arrow icon.
- Toolbar Theme:** A drop-down menu currently set to 'Light'.

At the bottom of the section is a blue button labeled 'Toolbar Buttons'.

- **Toolbar Enabled:** Turn the toggle on to enable the button toolbar.
- **Show On Wake:** Turn the toggle on to show the virtual toolbar when the device wakes from standby timeout.
- **Show During Standby:** Turn the toggle on to show the virtual toolbar during standby timeout.
- **Toolbar Positioning:** Select the arrows to position the toolbar as preferred.
- **Toolbar Autohide Timeout:** Select a duration (in seconds) that must elapse before the virtual toolbar is automatically hidden.
- **Toolbar Theme:** Select Light or Dark theme using the drop-down list.

Device Display

Select **Device Display** to use the device display buttons.

System Update - Device Display

System Setup

General Settings Network Date/Time Control System Cloud Settings Button Toolbar Device Display 802.1x Configuration

— Device Display

Setup

Screensaver and Standby

Local Setup Sequence

Standby Timeout * Minutes

Screensaver Enabled

24 Hour Digital Clock Enabled

Outdoor Temperature Enabled



Indoor Temperature Enabled

Date Enabled

Date Format

Text Color *

Text Outline Color *

Text Font Face	<input type="text" value="Roboto-Regular"/>
Header Text Line 1	<input type="text"/>
Header Text Line 2	<input type="text"/>
Header Text Justification *	<input type="radio"/> Left <input type="radio"/> Center <input checked="" type="radio"/> Right
Header Text Bidirectional Text Direction *	<input checked="" type="radio"/> Left-To-Right <input type="radio"/> Right-To-Left
Background Image URL	<input type="text"/> 
Video URL	<input type="text"/>
Logo Setting	<input type="radio"/> None <input checked="" type="radio"/> Crestron <input type="radio"/> Custom
Logo URL	<input type="text"/> 

- **Setup**
 - **Local Setup Sequence:** Turn the toggle on to allow local access to the setup screens using a five-finger press.
- **Screensaver and Standby**
 - **Standby Timeout:** Select a **Standby Timeout** duration (1–120 minutes) by using the up/down arrow buttons or by entering a duration in the field.
 - **Screensaver Enabled:** Turn the toggle on to show a screensaver on the device during standby timeout.
 - **24 Hour Digital Clock Enabled:** Turn the toggle on to display a 24-hour digital clock on the device during standby timeout.
 - **Outdoor Temperature Enabled:** Turn the toggle on to display the outdoor temperature on the device during standby timeout.
 - **Indoor Temperature Enabled:** Turn the toggle on to display the indoor temperature on the device during standby timeout.
 - **Date Enabled:** Turn the toggle on to display the date on the device during standby timeout.
 - **Date Format:** Use the drop-down list to select a date display format.
 - **Text Color:** Select to display a pop-up window for selecting the screensaver text color, or enter a hex value for a specific color.
 - **Text Outline Color:** Select to display a pop-up window for selecting the screensaver text outline color, or enter a hex value for a specific color.
 - **Text Font Face:** Use the drop-down list to select a font for the screensaver text.
 - **Header Text Line 1:** Enter text to be displayed on the first header text line of device screensaver.
 - **Header Text Line 2:** Enter text to be displayed on the second header text line of device screensaver.
 - **Header Text Justification:** Select one of the radio buttons (**Left, Center, or Right**) to select how the header text is justified on the device screensaver.
 - **Header Text Bidirectional Text Direction:** Select one of the radio buttons (**Left-To-Right or Right-To-Left**) to determine the language text direction on the device screensaver.
 - **Background Image URL:** Enter a **Background Image URL** to be used by the device screensaver.
 - **Video URL:** Enter a **Video URL** to be used by the device screensaver.
 - **Logo Setting:** Select one of the radio buttons (**None, Crestron, and Custom**) to select a logo type to use on the device screensaver.
 - **Logo URL:** If **Logo Setting** is set to **Custom**, enter a custom **Logo URL** to be used by the device screensaver.

802.1x Configuration

Select **802.1x Configuration** to display selections for configuring IEEE 802.1x network authentication for device security.

System Setup - 802.1x Configuration

The screenshot shows the 'System Setup' interface with the '802.1x Configuration' page selected. The navigation bar includes 'General Settings', 'Network', 'Date/Time', 'Control System', 'Cloud Settings', 'Button Toolbar', 'Device Display', '802.1x Configuration', and 'Device Audio'. The main content area is titled '802.1x Configuration' and contains the following settings:

- Network Isolation:** A toggle switch that is currently turned off.
- IEEE 802.1x Authentication:** A toggle switch that is currently turned off.
- Authentication Method:** A dropdown menu set to 'EAP MSCHAP V2- password'.
- Domain:** An empty text input field.
- User Name:** An empty text input field.
- Password:** A text input field with masked characters (dots).
- Enable Authentication Server Validation:** A toggle switch that is currently turned off.
- Select Trusted Certificate Authority(ies):** A list box with a search icon and a scrollbar. The visible items are:
 - AAA Certificate Services
 - AC RAIZ FNMT-RCM
 - SERVIDORES SEGUROS

- **Network Isolation:** Turn the toggle on to use 802.1x authentication for the device.
- **EEE 802.1x Authentication:** Turn the toggle on to use 802.1x authentication for the device.
- **Authentication Method:** Select an 802.1x authentication method (**EAP-TLS Certificate** or **EAP MSCHAP V2- password**) from the drop-down list.
- **Domain:** If **EAP MSCHAP V2- password** is selected for Authentication Method, enter a domain name for authentication.
- **Username:** If **EAP MSCHAP V2- password** is selected for Authentication Method, enter a username for authentication.
- **Password:** If **EAP MSCHAP V2- password** is selected for Authentication Method, enter a password for authentication.
- **Enable Authentication Server Validation:** Turn the toggle on to use server validation for elevated security.
- **Select Trusted Certificate Authorities:** Select trusted CAs (Certificate Authorities) from the provided CAs to be used for server validation:
 - Select the corresponding check box for each CA that you wish to make a trusted CA.
 - Enter a search term into the text field to search for and display CAs that match the search term.
 - Select the check box in the search field to select all CAs as trusted CAs.

Device Audio

Select **Device Audio** to use the device audio settings.

The screenshot shows the 'System Setup' interface with the 'Device Audio' tab selected. The settings are as follows:

Setting	Value
Panel Mute	Off (toggle)
Panel Volume	75 %
Media Mute	Off (toggle)
Media Volume	100 %

- **Panel Mute:** Turn the toggle on to mute the main device volume.
- **Panel Volume:** Enter a value (1–100) for the main device volume level.
- **Media Mute:** Turn the toggle on to mute the device media volume.
- **Media Volume:** Enter a value (1–100) for the device media volume level.

NOTE: Media Mute and Media Volume are functional for a connected video display.

Auto Update

Select **Auto Update** to configure the auto update feature. The auto update feature allows the device to automatically scan for firmware updates and install the updates as needed.

Settings - Auto Update

Auto Update

Auto Update

Schedule

Auto Update

Custom URL

Custom URL Path

Day of Week

Time of Day

Poll Interval Minutes

Update Now

- **Auto Update:** Turn the toggle on to allow automatic updates.
- **Custom URL:** Turn the toggle on to use a custom update server URL. If turned off, the server URL will default to the standard Crestron update server.
- **Custom URL Path:** If Custom URL is turned on, enter the custom URL path for the update server.
- **Schedule:** Set the schedule for when the device checks for updates.
 - **Day of Week:** Select the day of the week when the device will check for updates. Select **Daily** to have the device check for updates every day.
 - **Time of Day:** Enter a time of day (in 24-hour format) when the device will check for updates on the scheduled day.
 - **Poll Interval:** Enter the polling interval (in minutes) for when the device will poll the server for updates.

HDMI Input

Select **HDMI Input** from the navigation menu to display collapsible accordions for configuring the HDMI input settings.

Select an accordion name to expand the section. If the section is expanded, select the accordion name again to collapse it.

Settings - HDMI Input

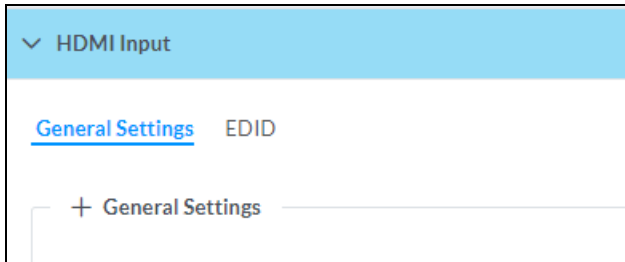

General Settings

Expand the **General Settings** accordion to configure general settings for the HDMI input.

Settings - HDMI Input - General Settings

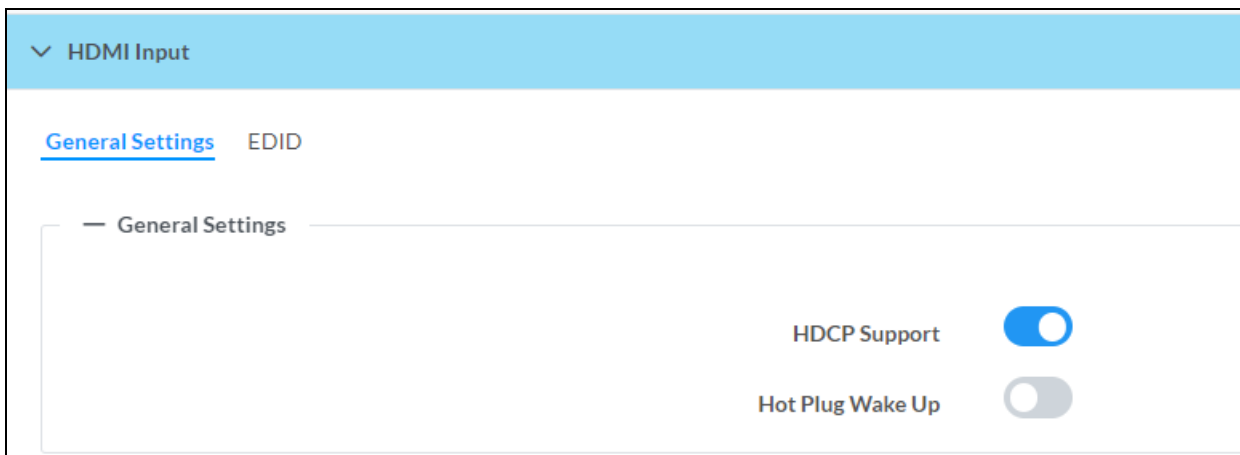

- **HDCP Support:** Turn the toggle on to activate HDCP (high-bandwidth digital content protection) support for the HDMI input.

When HDCP Support is turned on, source signals that require HDCP compliance are allowed to pass through to the display that is connected to the HDMI output. When HDCP Support is turned off, source signals that require HDCP compliance are not allowed to pass through to the connected display.

NOTE: When HDCP Support is turned on, the connected display must also be HDCP compliant.

- **Hot Plug Wake Up:** Turn the toggle on to have the display wake when a source is plugged into the HDMI input while the Digital Graphics Engine is running.

EDID

EDID is a data structure provided by a digital display to describe its capabilities for a video source (such as a graphics card or a set-top box). EDID allows a source device to identify the types of monitors that are connected to it.

Expand the EDID accordion to configure EDID (extended display identification data) settings for the HDMI input.

Settings - HDMI Input - EDID

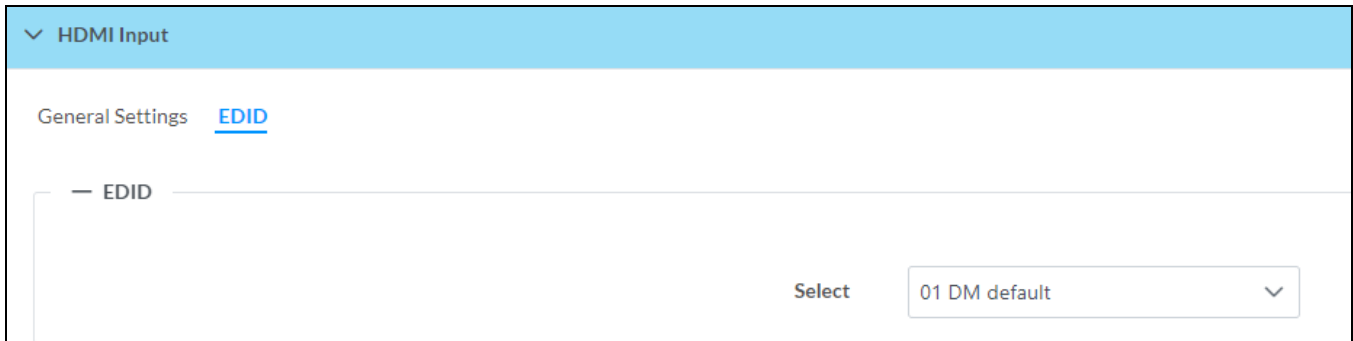

The screenshot shows a settings interface for the HDMI input. At the top, there is a blue header with a downward arrow and the text "HDMI Input". Below this, there are two tabs: "General Settings" and "EDID", with "EDID" being the active tab. Under the "EDID" tab, there is a section titled "EDID" with a minus sign to its left. To the right of this section, there is a "Select" label followed by a drop-down menu. The drop-down menu currently displays "01 DM default" and has a downward arrow on its right side.

Use the **Select** drop-down list to select an EDID profile for the HDMI input.

HDMI Output

Select **HDMI Output** from the navigation menu to display collapsible accordions for configuring the HDMI output settings.

Select an accordion name to expand the section. If the section is expanded, select the accordion name again to collapse it.

Settings - HDMI Output

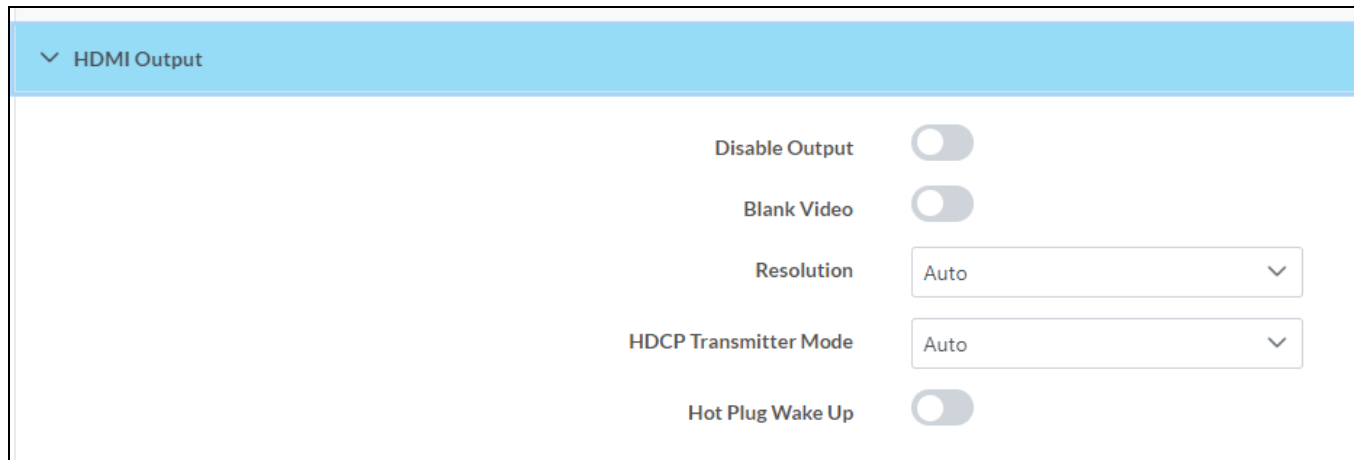

▼ HDMI Output

Disable Output

Blank Video

Resolution

HDCP Transmitter Mode

Hot Plug Wake Up

- **Disable Output:** Turn the toggle on to disable the HDMI output. When the output is disabled, no video signal will be passed to the display connected to the HDMI output.
- **Blank Video:** If Disable Output is disabled, turn the toggle on to use output blanking for the HDMI output.
- **Resolution:** Use the drop-down list to select a compatible resolution for the HDMI output signal.
- **HDCP Transmitter Mode:** Use the drop-down list to select a HDCP transmitter mode for the HDMI output.
 - When **HDCP Transmitter Mode** is set to **Auto**, the device uses HDCP if support is detected on the display device.
 - When **HDCP Transmitter Mode** is set to **Follow Input**, the device uses HDCP if support is detected on the HDMI input.
 - When **HDCP Transmitter Mode** is set to **Force Highest**, the device uses the latest version of HDCP, regardless of whether or not support is detected on the display device.
 - When **HDCP Transmitter Mode** is set to **Never Authenticate**, the device never uses HDCP transmitter mode, regardless of support.
- **Hot Plug Wake Up:** Turn the toggle on to wake the display when a source is plugged into the HDMI output while the Digital Graphics Engine is running.

Access Control

Select **Access Control** to configure the **Current User**, **Users**, and **Groups** features.

Settings - Access Control

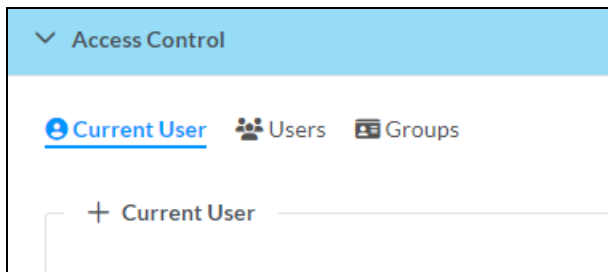

Current User

Select the **Current User** tab to view and edit information for the current device user.

Settings - Access Control - Current User

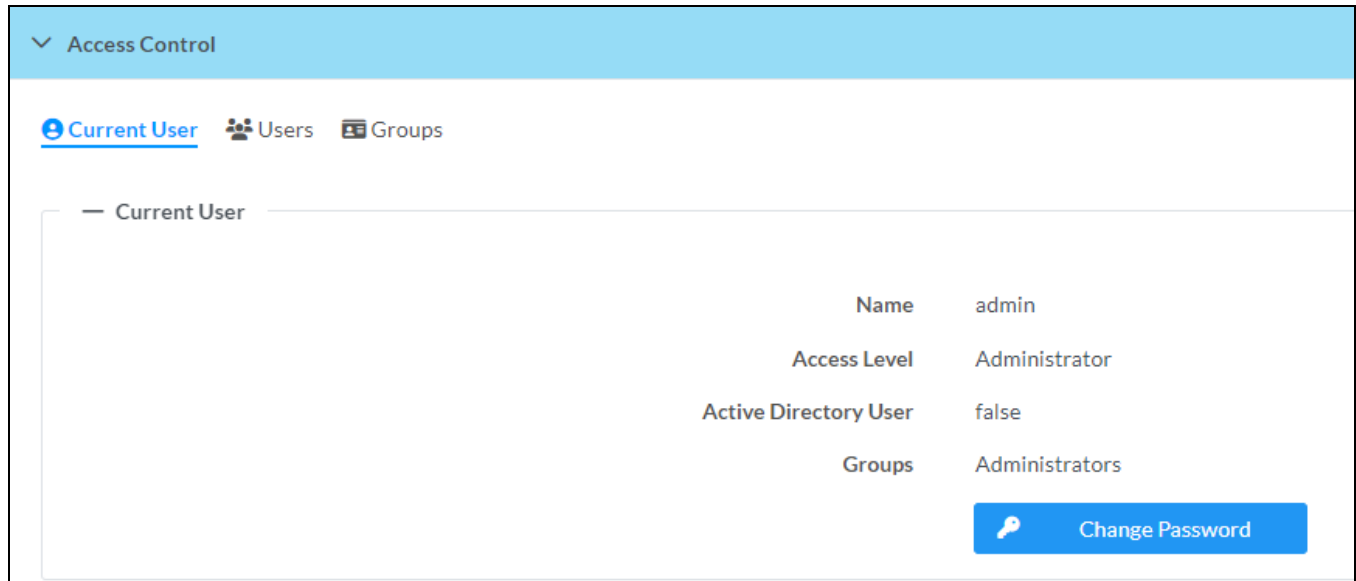

The following settings are displayed for the current user:

- **Name:** The chosen username
- **Access Level:** The access level granted to the user (**Administrator**, **Programmer**, **Operator**, **User**, or **Connect**)
- **Active Directory User:** Reports whether the current user is **True** (authenticated) or **False** (not authenticated) through Active Directory® software.

NOTE: A user must be added to an Active Directory group before the user is authenticated.

- **Groups:** Any groups of which the current user is a member

Select **Change Password** to change the password for the current user. The **Change Password** dialog box is displayed.

Change Password Dialog Box

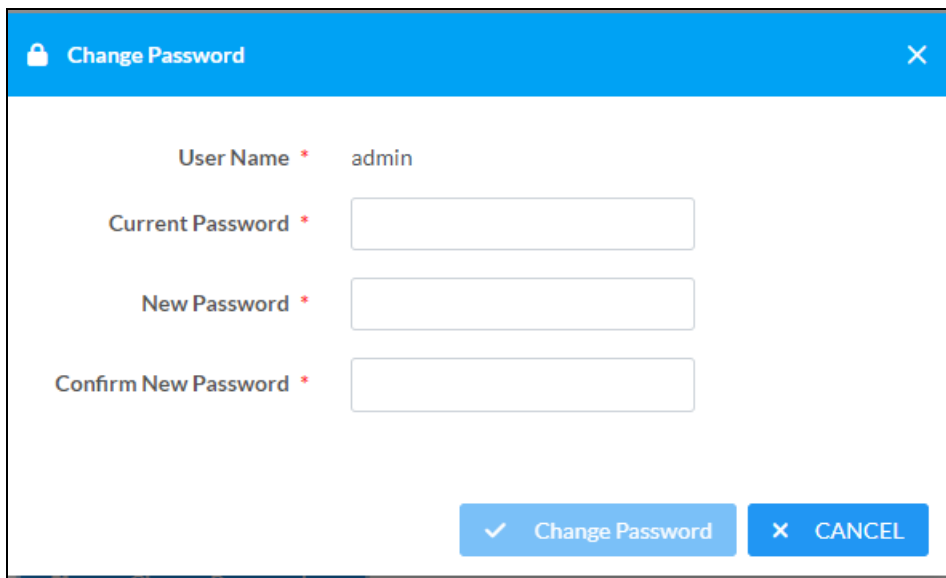

The image shows a 'Change Password' dialog box with a blue header bar containing a lock icon and a close button. The main area is white and contains four labeled input fields: 'User Name *' with the value 'admin', 'Current Password *', 'New Password *', and 'Confirm New Password *'. At the bottom right, there are two buttons: 'Change Password' with a checkmark icon and 'CANCEL' with an 'X' icon.

Enter the existing password in the **Current Password** field. Then, enter a new password in the **New Password** field, and reenter the password in the **Confirm Password** field.

Select **Change Password** to save the new password, or select **Cancel** to cancel the change.

Users

Select **Users** to view and edit user information.

Settings - Access Control - Users

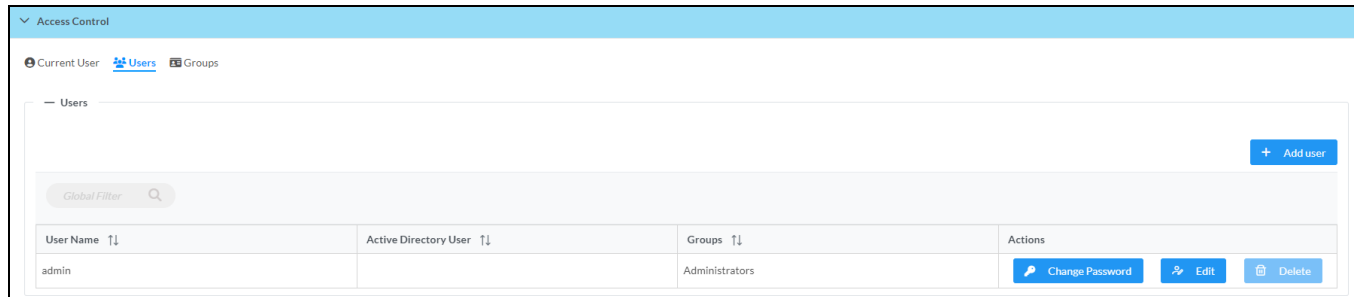

Enter text into the **Search Users** field to find and display users that match the search term(s).

Users are listed in table format. The following information is displayed for each user:

- **User Name:** The chosen username
- **Active Directory User:** Reports whether the user is authenticated through Active Directory

NOTE: A user must be added to an Active Directory group before the user is authenticated.

- **Groups:** Any groups of which the current user is a member
- **Actions:**
 - Select **Change Password** to change the password for the current user.
 - Select **Edit User** to update **Temporary Password** and **Groups**.

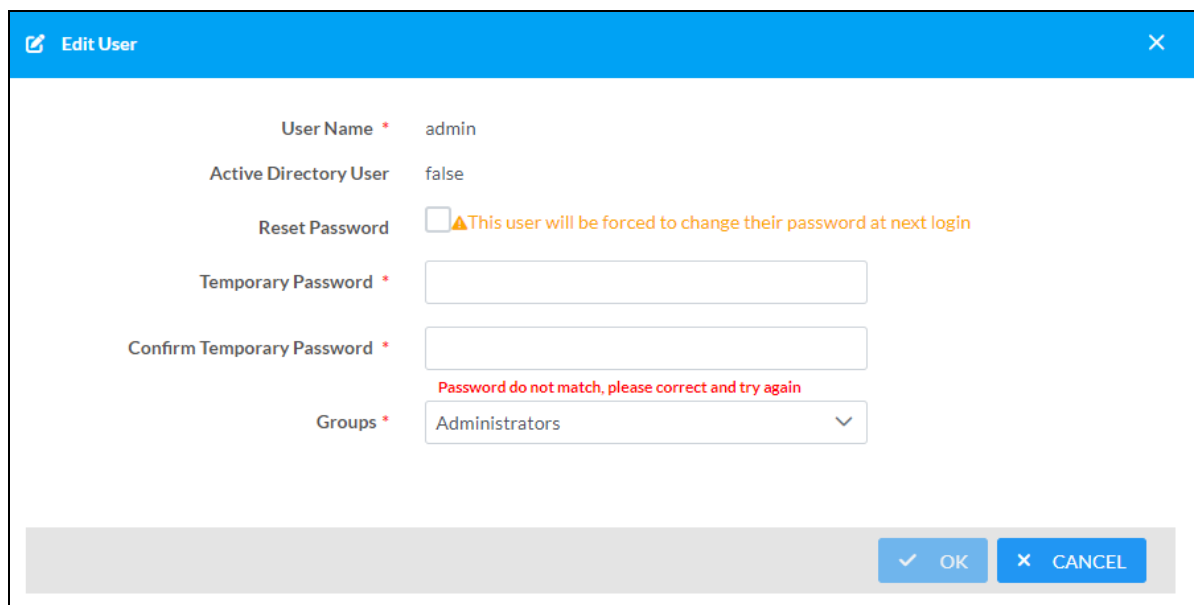

Select **Add User** to add a new user. The **Add User** dialog box is displayed.

Add User Dialog Box

The image shows a dialog box titled "Add user". It contains the following fields and controls:

- User Name ***: A text input field.
- Active Directory User**: A toggle switch.
- Password ***: A text input field.
- Confirm New Password ***: A text input field.
- Groups ***: A drop-down menu.

At the bottom right of the dialog, there are two buttons: **OK** (with a checkmark icon) and **CANCEL** (with an X icon).

- **User Name:** Enter the User Name in the **User Name** field.
- **Active Directory User:** Turn the toggle on for the **Active Directory User** to authenticate the **User Name**.
- **Password:** Enter a password in the **Password** field.
- **Confirm New Password:** Re-enter the password in the **Confirm New Password** field.
- **Groups:** Select **Groups** from the drop-down list.

Select **OK** to save, or select **Cancel** to cancel the change.

Groups

Settings - Access Control - Groups

Select **Groups** to view and edit group settings. Digital Graphics Engine groups are used to group users by access level and Active Directory authentication settings.

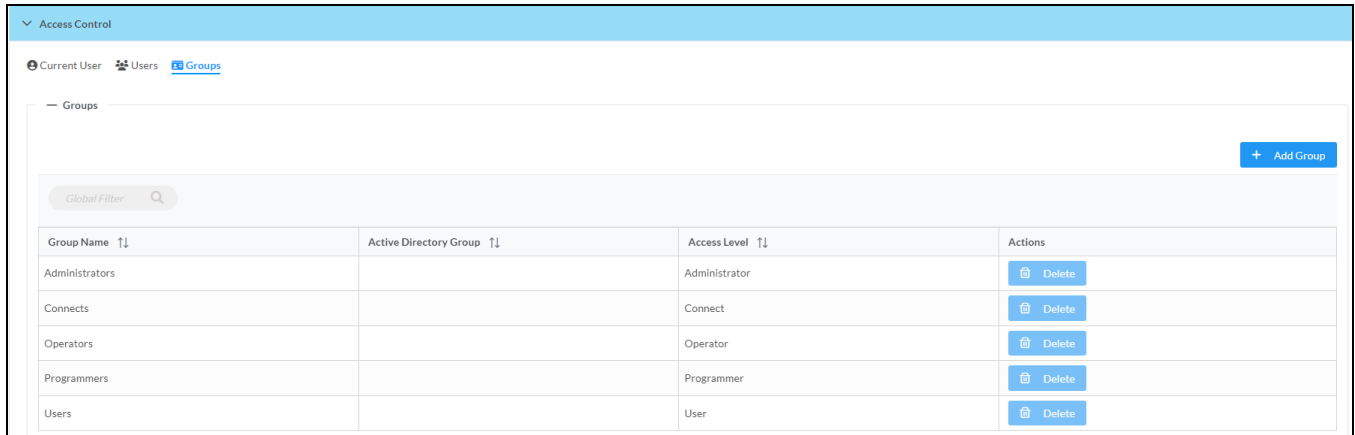

Enter text in to the **Global Filter** field to find and display groups that match the search term(s). Groups are listed in table format. The following information is displayed for each group:

- **Group Name:** The chosen group name
- **Active Directory Group:** Reports whether the user is authenticated through Active Directory

NOTE: Active Directory provides an additional layer of authentication for the groups and users. Active directory group and user names are stored in the device console along with a unique SID (security identifier). When an Active Directory user attempts to authenticate against the console, the console first checks the user credentials. If the Active Directory authentication is successful, Active Directory queries the console for the user or group's SID. The user is granted access to the device only if at least one SID match is found.

- **Access Level:** The **Access Level** for the selected group (**Administrator, Programmer, Operator, User, or Connect**)

An **Actions** column is also provided for each group that allows various actions to be performed. The following selections may be selected from the **Actions** column.

Select **Add Group** to add a new user. The **Add Group** dialog box is displayed.

Add Group Dialog Box

- **Group Name:** Enter the Group Name in the **Group Name** field.
- **Active Directory Group:** Turn the toggle on for the **Active Directory Group** to authenticate the **Group Name**.
- **Access Level:** Select **Access Level** from the drop-down list.

Select **OK** to save, or select **Cancel** to cancel the change.

TLS

Select **TLS** to configure the settings of the **TLS** (Transport Layer Security).

Status - TLS

The following **TLS** information is displayed:

- **Disable trust list verification:** If enabled, the device will check that the certificate received from the control system is trusted by this device.
- **Disable DNS host name verification:** If enabled, the device will check that the certificate received has the hostname of the control system that is trying to connect to.
- **Disable extended key usage verification:** If enabled, the device will check that the certificate received from the control system has an "Extended Key Usage" field and has "TLS Web Server Authentication" enabled.

Resources

The following resources are provided for the DGE-1000.

NOTE: You may need to provide your Crestron.com web account credentials when prompted to access some of the following resources.

Crestron Support and Training

- [Crestron True Blue Support](#)
- [Crestron Resource Library](#)
- [Crestron Online Help \(OLH\)](#)
- [Crestron Technical Institute \(CTI\) Portal](#)

Programmer and Developer Resources

- help.crestron.com: Provides help files for Crestron programming tools such as SIMPL, SIMPL#, and Crestron Toolbox™ software
- developer.crestron.com: Provides developer documentation for Crestron APIs, SDKs, and other development tools

Product Certificates

To search for product certificates, refer to the [Product Certificates](#) section of the Crestron Resource Library.

