



View this document in HTML
crestron.com/docs/9259



Product Manual

DM[®] Essentials

4K60 4:4:4 Endpoints

Have feedback on this document? Contact docfeedback@crestron.com.

The original language version of this document is U.S. English.
All other languages are a translation of the original document.

Regulatory Model: M202045001, M202046002, M202046003, M202046004, M202047002, M202047003, M202047004, M202047005, M202047006

Crestron product development software is licensed to Crestron dealers and Crestron Service Providers (CSPs) under a limited nonexclusive, nontransferable Software Development Tools License Agreement. Crestron product operating system software is licensed to Crestron dealers, CSPs, and end-users under a separate End-User License Agreement. Both of these Agreements can be found on the Crestron website at www.crestron.com/legal/software_license_agreement.

The product warranty can be found at www.crestron.com/warranty.

The specific patents that cover Crestron products are listed online at www.crestron.com/legal/patents.

Certain Crestron products contain open source software. For specific information, please visit www.crestron.com/opensource.

Crestron, the Crestron logo, .AV Framework, DM, and DM Lite are either trademarks or registered trademarks of Crestron Electronics, Inc. in the United States and/or other countries. Dolby Digital and Dolby Vision are either trademarks or registered trademarks of Dolby Laboratories in the United States and/or other countries. DTS is either a trademark or registered trademark of DTS, Inc. in the United States and/or other countries. HDMI and the HDMI logo are either trademarks or registered trademarks of HDMI Licensing LLC in the United States and/or other countries. TOSLINK is either a trademark or registered trademark of Toshiba Electronics Devices & Storage Corporation in the United States and/or other countries. USB Type-C and USB-C are either trademarks or registered trademarks of USB Implementers Forum, Inc. in the United States and/or other countries. DisplayPort is either a trademark or registered trademark of Video Electronics Standards Association in the United States and/or other countries. Other trademarks, registered trademarks, and trade names may be used in this document to refer to either the entities claiming the marks and names or their products. Crestron disclaims any proprietary interest in the marks and names of others. Crestron is not responsible for errors in typography or photography.

HDMI

©2025 Crestron Electronics, Inc.

Contents

Overview	1
Models	2
Features	4
DM Essentials Interoperability	6
4K60 4:4:4 and HDR Support	6
Integrated Web Server (Certain Models Only)	6
Automatic Switching of Inputs (Certain Models Only)	6
USB-C DisplayPort Input with Charging Capability (Certain Models Only)	7
Analog Audio Embedding (Certain Models Only)	7
Analog Audio De-Embedding (Certain Models Only)	7
S/PDIF Optical Digital Audio Return (Certain Models Only)	8
USB 2.0 Data Extension (Certain Models Only)	8
Ethernet Pass-Through Capability (Certain Models Only)	8
Surface-Mountable or Wall Plate Design	8
Physical Description	9
Surface-Mountable Transmitters	9
Wall Plate Transmitters	24
Surface-Mountable Receivers	32
Wall Plate Receivers	38
Specifications	42
Installation	44
Installation Guidelines	45
DM Essentials Cabling	45
HDMI Cabling	46
Power Connection	46
Surface-Mountable Device Installation	49
In the Box	49
Installing a Surface-Mountable Device	51
Connecting a Surface-Mountable Device	59
Wall Plate Device Installation	81
In the Box	81
Installing a Wall Plate Device	82
Connecting a Wall Plate Device	92
Configuration	111
Accessing the Web Interface	111
Navigating the Web Interface	114
Saving Configuration Changes	115
Viewing Status Information	117
Device	118

Occupancy Sensor	120
Input/Output	121
Network	122
Control System	123
Configuring Setup and Operational Settings	124
System Setup	125
Inputs	134
Outputs	139
Bring Your Own Meeting (BYOM)	151
Routing	152
Configuring Security Settings	160
SSL Mode	161
Authentication Management	161
Configuring IEEE 802.1X Settings	173
Management	175
Rebooting the Device	175
Restoring Factory Default Settings	177
Using the Web Interface	177
Using the SETUP Button	178
Using Crestron Toolbox Software	178
Updating Firmware	179
Downloading Message Logs	181
Managing Certificates	182
Managing Root Certificates	183
Managing Intermediate Certificates	187
Managing Machine Certificates	190
Managing Web Server Certificates	194
Managing EDIDs	199
Viewing Default EDIDs	200
Managing User EDIDs	202
Managing Device Drivers	205
Viewing Default Drivers	206
Managing User Drivers	208
Downloading a Configuration File	213
Uploading a Configuration File	214
Managing an Occupancy Sensor	216
Adding an Occupancy Sensor	217
Removing an Occupancy Sensor	218
Managing Schedules	219
Adding a Schedule	220
Deleting a Schedule	224
Resources	227
Crestron Support and Training	227
Programmer and Developer Resources	227

Product Certificates227

Overview

DM® Essentials 4K60 4:4:4 extenders transport various signal types over CATx cable in point-to-point applications. Consisting of a wide variety of DM Essentials transmitters and receivers, the extenders offer the capability to transport HDMI®, USB-C® DisplayPort™ (DisplayPort Alt Mode), analog audio, RS-232, IR, and USB 2.0 signals. The transmitters and receivers support video resolutions up to 4K60 with 4:4:4 color sampling.

A CAT5e or higher cable is used to connect a DM Essentials 4K60 4:4:4 transmitter to a DM Essentials 4K60 4:4:4 receiver. For 1080p, WUXGA, and 2K signals, a cable length of up to 230 ft (70 m) is supported. For UHD and 4K signals, a cable length of up to 130 ft (40 m) is supported.

In addition to interoperability between a DM Essentials 4K60 4:4:4 transmitter and receiver, various extenders (model dependent) are also interoperable with DMPS Essentials switchers and with DM Essentials 4K60 4:2:0 transmitters and receivers. A CAT5e or higher cable is used to connect a DM Essentials 4K60 4:4:4 extender to a DMPS Essentials switcher or DM Essentials 4K60 4:2:0 extender.

DM Essentials 4K60 4:4:4 extenders are available as surface-mountable devices and as wall plate devices. Surface-mountable devices are designed for mounting onto a flat surface such as a wall. Wall plate devices are designed for installation into an electrical box.

This section provides information about the following:

- [Models](#)
- [Features](#)
- [Physical description](#)

Models

The following table provides a list of DM Essentials 4K60 4:4:4 transmitters and receivers.

NOTE: For assistance in selecting DM Essentials transmitters and receivers, use the [DMPS Essentials and DM Essentials Product Selector](#) tool on the Crestron website.

Model	Description
TRANSMITTERS	
Transmitters, Surface-Mountable	
HD-TX-4KZ-101	HDMI® Signal Extension over CATx Cable
HD-TXA-4KZ-101	HDMI and Analog Audio Signal Extension over CATx Cable
HD-TXC-4KZ-101	HDMI, RS-232, and IR Signal Extension over CATx Cable
HD-TXCA-4KZ-101	HDMI, RS-232, IR, and Analog Audio Signal Extension over CATx Cable
HD-TX-4KZ-111	USB-C® DisplayPort™ Signal Extension over CATx Cable
HD-TX-4KZ-201	2x1 Auto-Switcher, HDMI Signal Extension over CATx Cable
HD-TX-4KZ-211-CHGR	2x1 Auto-Switcher, HDMI and USB-C DisplayPort Signal Extension over CATx Cable with Device Charging
HD-TX-4KZ-401	4x1 Auto-Switcher, HDMI Signal Extension over CATx Cable
HD-TX-4KZ-421-CHGR	4x1 Auto-Switcher, HDMI and USB-C DisplayPort Signal Extension over CATx Cable with Device Charging
HD-TXU-4KZ-111-E	USB C DisplayPort, USB 2.0, and Ethernet Signal Extension over CATx Cable
HD-TXU-4KZ-211	2x1 Auto-Switcher for HDMI, USB-C DisplayPort, and USB 2.0 Signal Extension over CATx Cable
HD-TXU-4KZ-211-CHGR	2x1 Auto-Switcher for HDMI, USB-C DisplayPort, and USB 2.0 Signal Extension over CATx Cable with Device Charging
Transmitters, Wall Plate	
HD-TX-4KZ-101-1G-B	HDMI Signal Extension over CATx Cable, 1 Gang, Black
HD-TX-4KZ-101-1G-W	HDMI Signal Extension over CATx Cable, 1 Gang, White
HD-TXA-4KZ-101-1G-B	HDMI and Analog Audio Signal Extension over CATx Cable, 1 Gang, Black
HD-TXC-4KZ-101-1G-B	HDMI, RS-232, and IR Signal Extension over CATx Cable, 1 Gang, Black
HD-TXC-4KZ-101-1G-W	HDMI, RS-232, and IR Signal Extension over CATx Cable, 1 Gang, White
HD-TX-4KZ-111-1G-B	USB-C DisplayPort Signal Extension over CATx Cable, 1 Gang, Black
HD-TX-4KZ-111-1G-W	USB-C DisplayPort Signal Extension over CATx Cable, 1 Gang, White

Model	Description
HD-TX-4KZ-211-2G-B	2x1 Auto-Switcher, HDMI and USB-C DisplayPort Signal Extension over CATx Cable, 2 Gang, Black
HD-TX-4KZ-211-2G-W	2x1 Auto-Switcher, HDMI and USB-C DisplayPort Signal Extension over CATx Cable, 2 Gang, White
HD-TXU-4KZ-111-2G-B	USB C DisplayPort and USB 2.0 Signal Extension over CATx Cable, 2 Gang, Black
HD-TXU-4KZ-111-2G-W	USB C DisplayPort and USB 2.0 Signal Extension over CATx Cable, 2 Gang, White

RECEIVERS

Receivers, Surface-Mountable

HD-RX-4KZ-101	HDMI Signal Extension over CATx Cable
HD-RXA-4KZ-101	HDMI and Analog Audio Signal Extension over CATx Cable
HD-RXC-4KZ-101	HDMI, RS-232, and IR Signal Extension over CATx Cable
HD-RXCA-4KZ-101	HDMI, RS-232, IR, and Analog Audio Signal Extension over CATx Cable
HD-RXU-4KZ-101-E	HDMI, USB 2.0, and Ethernet Signal Extension over CATx Cable
HD-RXU-4KZ-202	2x2 Auto-Switcher for HDMI and USB 2.0 Signal Extension over CATx Cable

Receivers, Wall Plate

HD-RX-4KZ-101-1G-B	HDMI Signal Extension over CATx Cable, 1 Gang, Black
HD-RXC-4KZ-101-1G-B	HDMI, RS-232, and IR Signal Extension over CATx Cable, 1 Gang, Black
HD-RXU-4KZ-101-2G-B	HDMI and USB 2.0 Signal Extension over CATx Cable, 2 Gang, Black

Features

Key features of DM Essentials 4K60 4:4:4 extenders include:

- DM Essentials transmitter interoperability with a DM Essentials receiver or DMPS Essentials switcher
- DM Essentials receiver interoperability with a DM Essentials transmitter or DMPS Essentials switcher
- Point-to-point extension of various signal types over a CAT5e or higher cable:
 - HDMI (all models excluding the HD-TX[U]-4KZ-111 Series)
 - USB-C DisplayPort (DisplayPort Alt Mode) (HD-TX-4KZ-111/211/421 Series, HD-TXU-4KZ-111 Series, and HD-TXU-4KZ-211 Series only)
 - Analog audio (HD-TXA[CA]-4KZ-101 Series and HD-RXA[CA]-4KZ-101 Series only)
 - Bidirectional RS-232 and IR pass-through (HD-TXC[A]-4KZ-101 Series and HD-RXC[A]-4KZ-101 Series only)
 - USB 2.0 (HD-TXU-4KZ Series and HD-RXU-4KZ Series only)
 - Ethernet (HD-TXU-4KZ-111-E and HD-RXU-4KZ-101-E only)
- DM Essentials transmission distance up to 130 ft (40 m) for UHD and 4K signals or up to 230 ft (70 m) for 1080p, WUXGA, and 2K signals
- 4K60 video with 4:4:4 color sampling
- HDR10, HDR10+, and Dolby Vision® video formats
- Enterprise-grade security (HD-TXU-4KZ-211 Series and HD-RXU-4KZ-202 only)
- Compliance with HDCP 2.3
- Integrated web server for device configuration and management (HD-TXU-4KZ-211 Series and HD-RXU-4KZ-202 only)
- EDID pass-through capability (all models excluding HD-TXU-4KZ-211 Series and HD-RXU-4KZ-202)
- EDID management (HD-TXU-4KZ-211 Series and HD-RXU-4KZ-202 only)
- CEC (Consumer Electronics Control) pass-through capability (all models excluding HD-TXU-4KZ-211 Series and HD-RXU-4KZ-202)
- Automatic display control using CEC (HD-TXU-4KZ-211 Series and HD-RXU-4KZ-202 only)
- Automatic switching of inputs on multi-input transmitters
- S/PDIF optical digital audio return (HD-TXCA-4KZ-101 and HD-RXCA-4KZ-101 only)
- USB-C DisplayPort input with charging capability (HD-TX-4KZ-211-CHGR, HD-TX-4KZ-421-CHGR, and HD-TXU-4KZ-211-CHGR only)
- Interoperability with a Crestron 3-Series® or later control system (HD-TXU-4KZ-211 Series and HD-RXU-4KZ-202 only)
- XiO Cloud® service support (HD-TXU-4KZ-211 Series and HD-RXU-4KZ-202 only)
- .AV Framework™ technology support (HD-TXU-4KZ-211 Series and HD-RXU-4KZ-202 only)
- Surface-mountable or wall plate design

- Power from one of the following:
 - Local 24VDC power pack
 - Remote surface-mountable DM Essentials transmitter or receiver (all models excluding HD-TXU-4KZ-211 Series and HD-RXU-4KZ-202)
 - Remote DMPS Essentials switcher (all models excluding HD-TXU-4KZ Series and HD-RXU-4KZ Series), HD-RXU-4KZ-101 Series, and
- Power pack included with surface-mountable DM Essentials transmitters and receivers

DM Essentials Interoperability

The DM Essentials output port of a DM Essentials 4K60 4:4:4 transmitter is designed for connection to a DM Essentials input port of a DM Essentials receiver or DMPS Essentials switcher. Similarly, the DM Essentials input port of a DM Essentials 4K60 4:4:4 receiver is designed for connection to a DM Essentials output port of a DM Essentials transmitter or DMPS Essentials switcher.

NOTE: For support of USB 2.0 data extension, HD-TXU-4KZ Series transmitters are designed to interoperate with HD-RXU-4KZ Series receivers only. Similarly, HD-RXU-4KZ Series receivers are designed to interoperate with HD-TXU-4KZ Series transmitters only.

For DM Essentials 4K60 4:4:4 extenders that can be paired with a DMPS Essentials switcher, the DM Essentials extender can be configured and controlled only when paired with the DMPS Essentials switcher. The web interface of the switcher can be used to configure the DM Essentials extender. In addition, control system programming and .AV Framework™ software support of the DM Essentials extender is hosted by the switcher. Supported DMPS Essentials switchers are the HD-PS Series (HD-PS622, HD-PS621, HD-PS402, and HD-PS401) and the HD-RX-4K-210-C-E(-POE).

NOTES:

- With the exception of HD-TXU-4KZ Series and HD-RXU-4KZ Series extenders, DM Essentials 4K60 4:4:4 extenders are also interoperable with DM Essentials 4K60 4:2:0 extenders (for example, the HD-TX-101-C-E transmitter and the HD-RX-101-C-E receiver).
- The [DMPS Essentials and DM Essentials Product Selector](#) tool is provided on the Crestron website for assistance in selecting DM Essentials transmitters and receivers in addition to DMPS Essentials switchers.

4K60 4:4:4 and HDR Support

DM Essentials 4K60 4:4:4 extenders support video resolutions up to 4K60 with 4:4:4 color sampling. HDR10, HDR10+, and Dolby Vision® video formats are also supported.

Integrated Web Server (Certain Models Only)

The HD-TXU-4KZ-211, HD-TXU-4KZ-211-CHGR, and HD-RXU-4KZ-202 include a web server that enables device configuration and management of the corresponding device. In addition, the web interface provided by the web server of an HD-TXU-4KZ-211 Series transmitter can be used to configure the HD-RXU-4KZ-202. Conversely, the web interface of the HD-RXU-4KZ-202 can be used to configure an HD-TXU-4KZ-211 Series transmitter.

Automatic Switching of Inputs (Certain Models Only)

NOTE: Automatic switching of inputs is applicable to the following multi-input devices: HD-TX-4KZ-201, HD-TX-4KZ-401, HD-TX-4KZ-211-CHGR, HD-TX-4KZ-421-CHGR, HD-TX-4KZ-211-2G, HD-TXU-4KZ-211, HD-TXU-4KZ-211-CHGR, and HD-RXU-4KZ-202.

When a multi-input HD-TX-4KZ Series transmitter is used with a DMPS Essentials switcher, the web interface of the switcher or control system programming can be used to configure the AV switching behavior of the transmitter. When a multi-input HD-TXU-4KZ Series transmitter is used with an HD-RXU-4KZ-202, the web interface of the transmitter or control system programming can be used to configure the AV switching behavior of the HD-RXU-4KZ-202. Conversely, the web interface of the HD-RXU-4KZ-202 or control system programming can be used to configure the AV switching behavior of a multi-input HD-TXU-4KZ-Series transmitter.

Automatic switching of the inputs can occur based on the last connected input or on the routing priority assigned to each input. In addition, one or more input selection push buttons on the front of the multi-input device enable the desired input to be selected manually.

USB-C DisplayPort Input with Charging Capability (Certain Models Only)

NOTE: Charging capability provided by a USB-C DisplayPort input is applicable to the HD-TX-4KZ-211-CHGR, HD-TX-4KZ-421-CHGR, and HD-TXU-4KZ-211-CHGR transmitters only.

The HD-TX-4KZ-211-CHGR and HD-TXU-4KZ-211-CHGR include one USB-C DisplayPort input with charging capability. The HD-TX-4KZ-421-CHGR includes two USB-C DisplayPort inputs with charging capability. When the transmitters are powered by the included power pack, a USB-C DisplayPort input can charge the connected AV source (for example, a laptop) with up to 60W of power. If the transmitters are powered by a remote DM Essentials receiver or DMPS Essentials switcher (if applicable), no charging capability is provided by a USB-C DisplayPort input.

Analog Audio Embedding (Certain Models Only)

NOTE: Analog audio embedding is applicable to the HD-TXA-4KZ-101 and HD-TXCA-4KZ-101 transmitters only.

The analog audio input port of the HD-TXA-4KZ-101 and HD-TXCA-4KZ-101 enables a balanced/unbalanced stereo audio source to be embedded with the video signal from the HDMI input. An audio selection push button is provided to switch between analog and HDMI audio inputs as desired. The audio selection push button is functional only when the transmitter is used with a DM Essentials 4K60 4:4:4 receiver or a DMPS Essentials HD-PS Series switcher.

Analog Audio De-Embedding (Certain Models Only)

NOTE: Analog audio de-embedding is applicable to the HD-RXA-4KZ-101 and HD-RXCA-4KZ-101 receivers only.

The analog audio output port of the HD-RXA-4KZ-101 and HD-RXCA-4KZ-101 enables 2-channel LPCM audio to be extracted from the AV signal.

S/PDIF Optical Digital Audio Return (Certain Models Only)

NOTE: S/PDIF optical digital audio return is applicable to the HD-TXCA-4KZ-101 transmitter and HD-RXCA-4KZ-101 receiver only.

The HD-TXCA-4KZ-101 receives S/PDIF optical digital audio from a device (for example, a display) connected to the S/PDIF optical digital audio input of the HD-RXCA-4KZ-101. The S/PDIF optical digital audio output of the HD-TXCA-4KZ-101 then transmits the audio to an AV receiver. Supported S/PDIF digital audio formats are Dolby Digital®, Dolby Digital EX, DTS®, DTS ES, and LPCM up to 6 channels.

USB 2.0 Data Extension (Certain Models Only)

NOTE: USB 2.0 data extension is applicable to the HD-TXU-4KZ Series transmitters (HD-TXU-4KZ-111-E, HD-TXU-4KZ-111-2G, HD-TXU-4KZ-211, and HD-TXU-4KZ-211-CHGR) and HD-RXU-4KZ Series receivers (HD-RXU-4KZ-101-E, HD-RXU-4KZ-101-2G, and HD-RXU-4KZ-202) only.

Two USB 2.0 host ports are provided on the HD-TXU-4KZ Series transmitters and HD-RXU-4KZ Series receivers. The ports enable connection to USB 2.0 peripheral devices. Various types of USB peripheral devices are supported, including mice, keyboards, whiteboards, touch screens, game controllers, cameras, mobile devices, headsets, printers, flash drives, hard drives, and USB hubs.

Ethernet Pass-Through Capability (Certain Models Only)

NOTE: Ethernet pass-through capability is applicable to the HD-TXU-4KZ-111-E transmitter and HD-RXU-4KZ-101-E receiver only.

The HD-TXU-4KZ-111-E is equipped with a 100/1000 Mbps LAN port that passes an Ethernet signal over the DM Essentials connection to the HD-RXU-4KZ-101-E receiver. The LAN port of the HD-TXU-4KZ-111-E can be connected to an Ethernet network or directly to an Ethernet-enabled device such as a PC. If the LAN port of the HD-TXU-4KZ-111-E is connected to an Ethernet network, the LAN port of the HD-RXU-4KZ-101-E must be connected to an Ethernet-enabled device. If the LAN port of the HD-TXU-4KZ-111-E is connected to an Ethernet-enabled device, the LAN port of the HD-RXU-4KZ-101-E must be connected to an Ethernet network.

Surface-Mountable or Wall Plate Design

DM Essentials transmitters and receivers are available as surface-mountable or wall plate devices. Surface-mountable devices are designed to be mounted onto a flat surface such as a wall. Wall plate devices (1 gang and 2 gang) are designed for installation into an electrical box.

Physical Description

The following sections provide information about the front and rear panels of DM Essentials 4K60 4:4:4 extenders based on the device type (transmitter or receiver) and form factor (surface-mountable or wall plate):

- [Surface-Mountable Transmitters](#)
- [Wall Plate Transmitters](#)
- [Surface-Mountable Receivers](#)
- [Wall Plate Receivers](#)

Surface-Mountable Transmitters

This section provides information about the front and rear panels of the following surface-mountable transmitters:

- [HD-TX\(A\)\(C\)\(CA\)-4KZ-1x1 Series](#)
- [HD-TX-4KZ-201 and HD-TX-4KZ-401](#)
- [HD-TX-4KZ-211-CHGR and HD-TX-4KZ-421-CHGR](#)
- [HD-TXU-4KZ-111-E](#)
- [HD-TXU-4KZ-211](#)
- [HD-TXU-4KZ-211-CHGR](#)

HD-TX(A)(C)(CA)-4KZ-1x1 Series

HD-TX(A)(C)(CA)-4KZ-1x1 Series transmitters consist of the following:

- HD-TX-4KZ-101
- HD-TXA-4KZ-101
- HD-TXC-4KZ-101
- HD-TXCA-4KZ-101
- HD-TX-4KZ-111

The front and rear panels of the HD-TX(A)(C)(CA)-4KZ-1x1 Series transmitters provide connectors, controls, and indicators as discussed in the following sections.

Front Panel

The following illustration shows the front panel of each of the HD-TX(A)(C)(CA)-4KZ-1x1 Series transmitters.

HD-TX(A)(C)(CA)-4KZ-1x1 Series Transmitters, Front Panel

**HD-TXCA-4KZ-101
Front Panel**

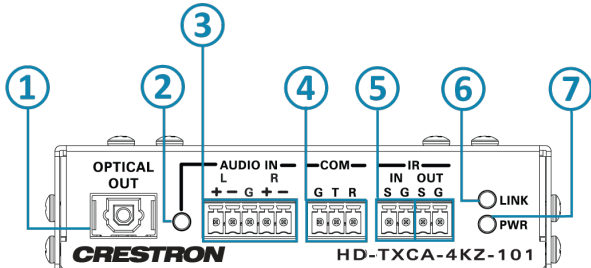

**HD-TXA-4KZ-101
Front Panel**

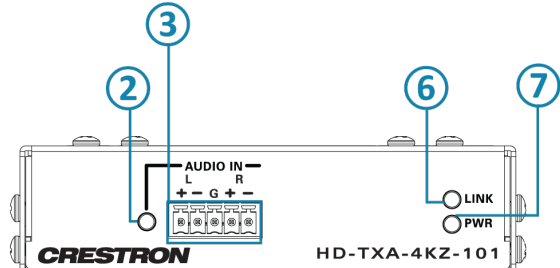

**HD-TXC-4KZ-101
Front Panel**

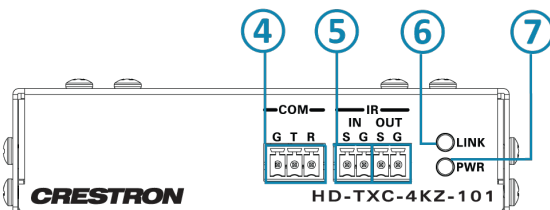

**HD-TX-4KZ-101
Front Panel**



**HD-TX-4KZ-111
Front Panel**



- ① **OPTICAL OUT Port:** JIS F05 female, TOSLINK® optical fiber connector; S/PDIF optical digital audio output, functional only when the HD-TXCA-4KZ-101 transmitter is used with the HD-RXCA-4KZ-101 receiver
- ② **AUDIO IN LED:** Green LED, indicates that analog audio is selected
- ③ **AUDIO IN Port:** 5-pin 3.5 mm detachable terminal block; Balanced/unbalanced stereo line-level audio input; Input Impedance: 24k Ohms balanced/unbalanced; Maximum Input Level: 4 Vrms balanced, 2 Vrms unbalanced

- ④ **COM Port:** 3-pin 3.5 mm detachable terminal block;
Bidirectional RS-232 port;
Passes RS-232 TD/RD data to/from the COM port on a DM Essentials receiver;
Supports up to 115.2k baud
- ⑤ **IR IN/OUT Ports:** 4-pin 3.5 mm detachable terminal block;
Comprised of (1) IR input port and (1) IR output port;
IR IN passes the IR input signal to the IR OUT port on the DM Essentials receiver;
IR OUT transmits the IR signal from the IR IN port on the DM Essentials receiver;
Supports IR up to 60 kHz
- ⑥ **LINK LED:** Green LED, indicates that a DM Essentials link is established
- ⑦ **PWR LED:** Lights to indicate that power is being applied to the device. Amber indicates that the device is booting. Green indicates that the device is operational.

Rear Panel

The following illustration shows the rear panel of each of the HD-TX(A)(C)(CA)-4KZ-1x1 Series transmitters.

HD-TX(A)(C)(CA)-4KZ-1x1 Series Transmitters, Rear Panel

HD-TXCA-4KZ-101 Rear Panel

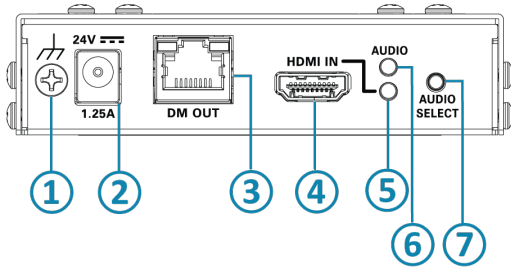

HD-TXA-4KZ-101 Rear Panel

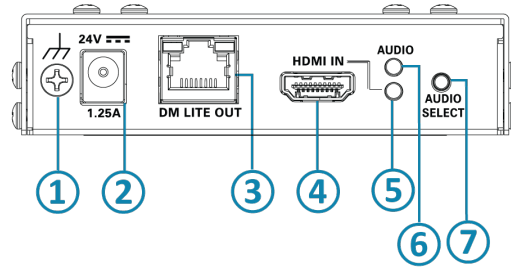

HD-TXC-4KZ-101 Rear Panel

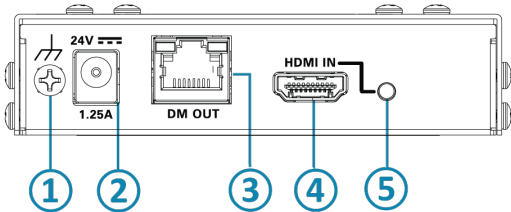

HD-TX-4KZ-101 Rear Panel

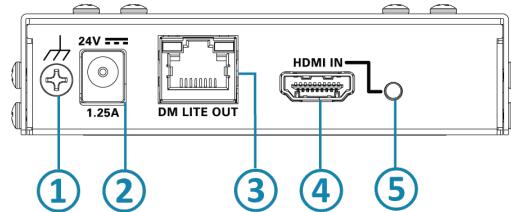

HD-TX-4KZ-111 Rear Panel

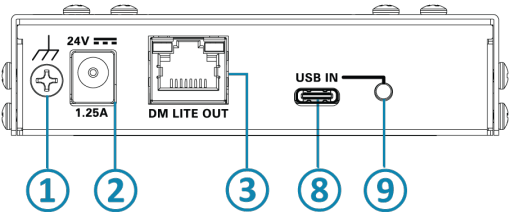

- ① **Ground:** Chassis ground lug
- ② **24V 1.25A Power Connector:** 2.1 x 5.5 mm DC power connector; 24VDC power input; PW-2420RU power pack included
- ③ **DM OUT Port:** 8-pin RJ-45 yellow connector, female, shielded; DM Essentials output port for connection to the DM Essentials input port of a DM Essentials receiver or DMPS Essentials switcher; Green LED indicates that a DM Essentials link is established; Flashing amber LED indicates non-HDCP video, and solid amber indicates HDCP video

- ④ **HDMI IN Port:** HDMI Type A connector, female;
HDMI digital video/audio input;
DVI and Dual-Mode DisplayPort™ interface compatible with appropriate adapter or interface cable (CBL-HD-DVI interface cables sold separately)
- ⑤ **HDMI IN LED:** Green LED, indicates that the device is receiving an HDMI signal
- ⑥ **AUDIO, HDMI IN LED:** Green LED, indicates that HDMI audio is selected
- ⑦ **AUDIO SELECT:** Push button, enables selection of HDMI or analog audio
- ⑧ **USB IN Port:** USB Type-C® connector, female;
Digital video/audio input using DisplayPort Alt Mode (CBL-USB3G1-C-C-6 and CBL-USB3G2-C-C-3 cables sold separately)
- ⑨ **USB IN LED:** Green LED, lights to indicate that the device is receiving a DisplayPort over USB-C (DisplayPort Alt Mode) input signal

HD-TX-4KZ-201 and HD-TX-4KZ-401

The front and rear panels of the HD-TX-4KZ-201 and HD-TX-4KZ-401 transmitters provide connectors, controls, and indicators as discussed in the following sections.

Front Panel

The following illustration shows the front panel of the HD-TX-4KZ-201 and HD-TX-4KZ-401 transmitters.

HD-TX-4KZ-201 and HD-TX-4KZ-401 Transmitters, Front Panel

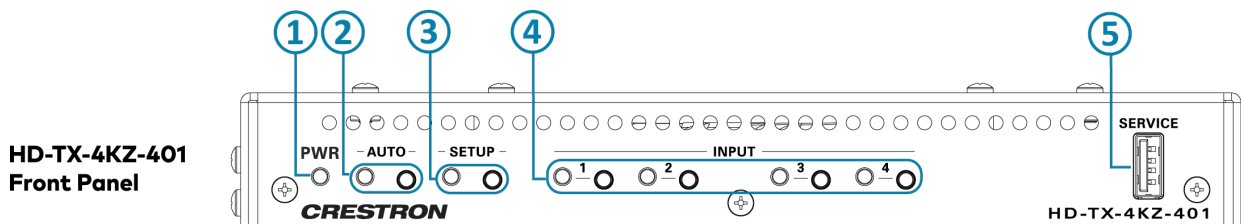
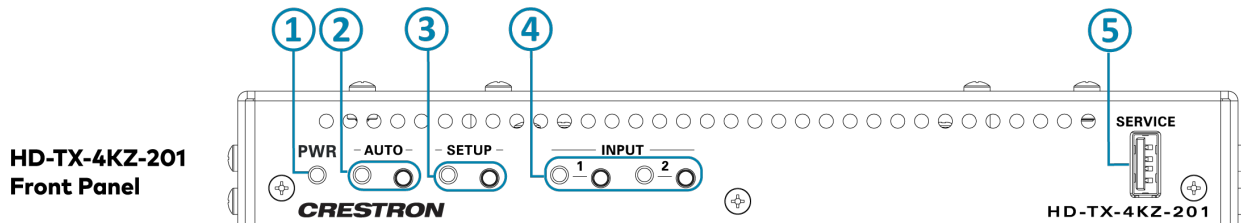

- ① **PWR LED:** Lights to indicate that power is being applied to the device. Amber indicates that the device is booting. Green indicates that the device is operational.
- ② **AUTO LED and Push Button:** Green LED, lights to indicate that automatic switching of inputs is enabled;
Push button, enables or disables automatic switching of inputs
- ③ **SETUP LED and Push Button:** Red LED, lights to indicate that the SETUP push button is pressed;
Push button, enables Ethernet setup, applicable only when the device is used with a DMPS Essentials switcher
- ④ **INPUT 1-2 or 1-4 LEDs and Push Buttons:** LEDs, green indicates that the corresponding HDMI input is routed to the output, and amber indicates that a source is detected but is not routed to the output;
Push buttons, enable manual selection of HDMI input
- ⑤ **SERVICE:** USB 2.0 Type-A connector, female;
Used for firmware loading, configuration management, or as a USB host port for one TT-100 series cable caddy (sold separately);
Can also provide up to 5V 500 mA power to a USB powered device

Rear Panel

The following illustration shows the rear panel of the HD-TX-4KZ-201 and HD-TX-4KZ-401 transmitters.

HD-TX-4KZ-201 and HD-TX-4KZ-401 Transmitters, Rear Panel

**HD-TX-4KZ-201
Rear Panel**

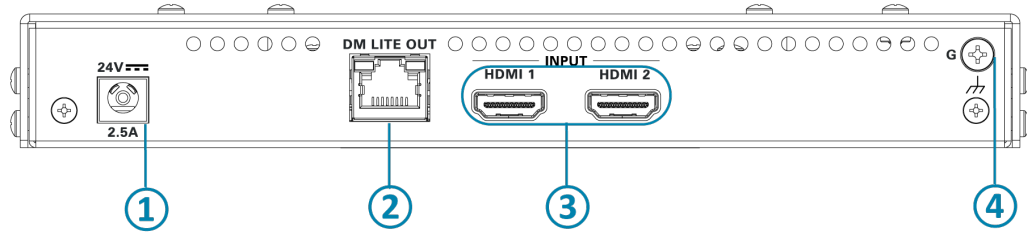

**HD-TX-4KZ-401
Rear Panel**

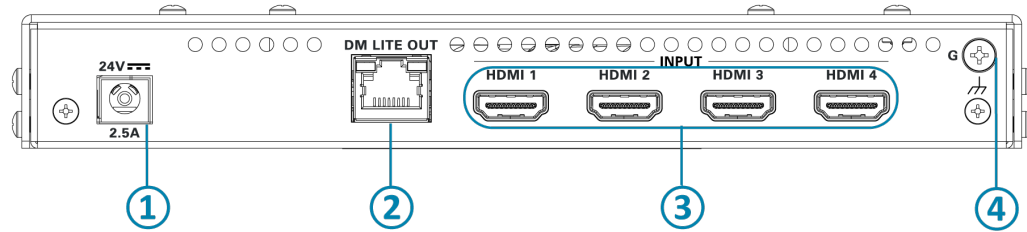

- ① **24V 2.5A Power Connector:** 2.1 x 5.5 mm DC power connector;
24VDC power input;
PW-2420RU power pack included
- ② **DM OUT Port:** 8-pin RJ-45 yellow connector, female, shielded;
DM Essentials output port for connection to the DM Essentials input port of a DM Essentials receiver or DMPS Essentials switcher;
Green LED indicates that a DM Essentials link is established;
Flashing amber LED indicates non-HDCP video, and solid amber indicates HDCP video
- ③ **HDMI IN 1-2 or 1-4 Ports:** HDMI Type A connectors, female;
HDMI digital video/audio inputs;
DVI and Dual-Mode DisplayPort™ interface compatible with appropriate adapter or interface cable (CBL-HD-DVI interface cables sold separately)
- ④ **Ground:** Chassis ground lug

HD-TX-4KZ-211-CHGR and HD-TX-4KZ-421-CHGR

The front and rear panels of the HD-TX-4KZ-211-CHGR and HD-TX-4KZ-421-CHGR provide connectors, controls, and indicators as discussed in the following sections.

Front Panel

The following illustration shows the front panel of the HD-TX-4KZ-211-CHGR and HD-TX-4KZ-421-CHGR transmitters.

HD-TX-4KZ-211-CHGR and HD-TX-4KZ-421-CHGR Transmitters, Front Panel

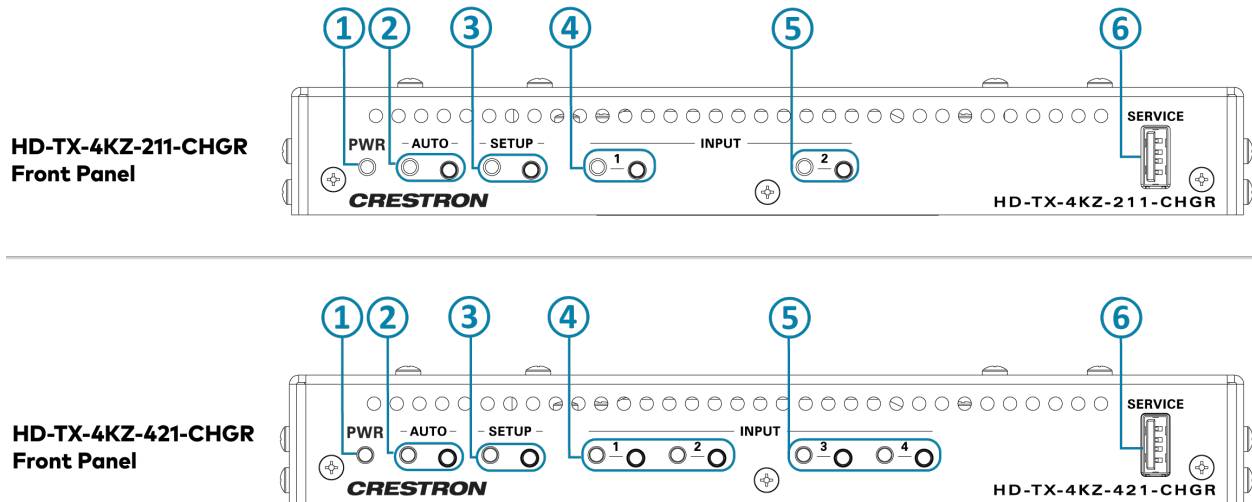

- ① **PWR LED:** Lights to indicate that power is being applied to the device. Amber indicates that the device is booting. Green indicates that the device is operational.
- ② **AUTO LED and Push Button:** Green LED, lights to indicate that automatic switching of inputs is enabled;
Push button, enables or disables automatic switching of inputs
- ③ **SETUP LED and Push Button:** Red LED, lights to indicate that the SETUP push button is pressed;
Push button, enables Ethernet setup, applicable only when the device is used with a DMPS Essentials switcher
- ④ **INPUT 1 or 1-2 LEDs and Push Buttons:** LEDs, green indicates that the corresponding HDMI input is routed to the output, and amber indicates that a source is detected but is not routed to the output;
Push buttons, enable manual selection of HDMI input
- ⑤ **INPUT 3 or 3-4 LEDs and Push Buttons:** LEDs, green indicates that the corresponding USB-C DisplayPort input is routed to the output, and amber indicates that a source is detected but is not routed to the output;
Push buttons, enable manual selection of USB-C DisplayPort input

- ⑥ **SERVICE:** USB 2.0 Type-A connector, female;
Used for firmware loading, configuration management, or as a USB host port for one TT-100 series cable caddy (sold separately);
Can also provide up to 5V 500 mA power to a USB powered device

Rear Panel

The following illustration shows the rear panel of the HD-TX-4KZ-211-CHGR and HD-TX-4KZ-421-CHGR transmitters.

HD-TX-4KZ-211-CHGR and HD-TX-4KZ-421-CHGR Transmitters, Rear Panel

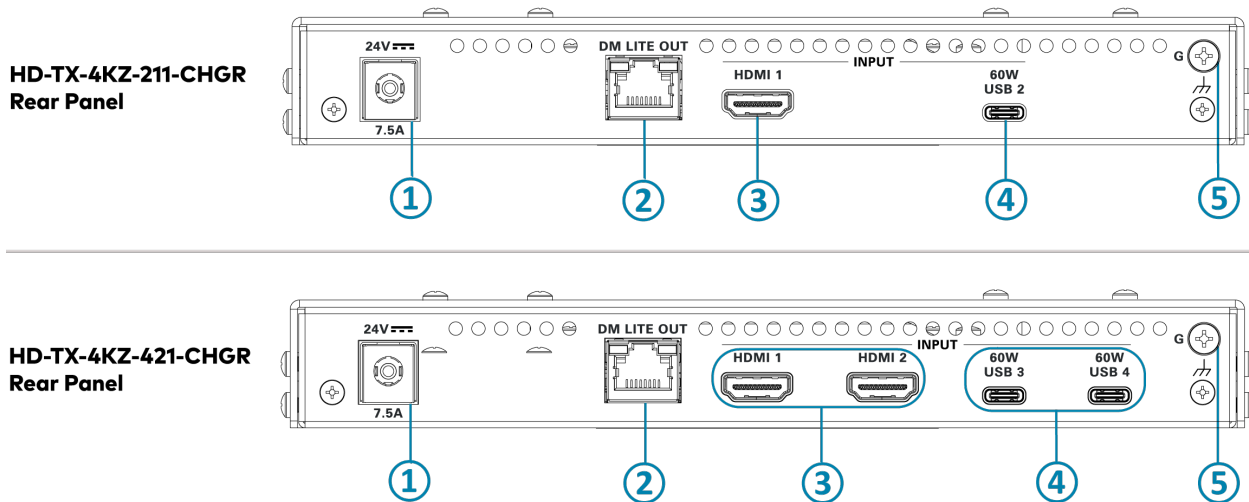

- ① **24V 7.5A Power Connector:** 2.5 x 5.5 mm DC power connector;
24VDC power input;
PW-2475DU power pack included
- ② **DM OUT Port:** 8-pin RJ-45 yellow connector, female, shielded;
DM Essentials output port for connection to the DM Essentials input port of a DM Essentials receiver or DMPS Essentials switcher;
Green LED indicates that a DM Essentials link is established;
Flashing amber LED indicates non-HDCP video, and solid amber indicates HDCP video
- ③ **HDMI INPUT 1 or 1-2 Ports:** HDMI Type A connectors, female;
HDMI digital video/audio inputs;
DVI and Dual-Mode DisplayPort™ interface compatible with appropriate adapter or interface cable (CBL-HD-DVI interface cables sold separately)
- ④ **60W USB INPUT 2 or 3-4 Ports:** USB Type-C® connectors, female;
Digital video/audio inputs using DisplayPort Alt Mode;
Each input can also charge connected AV source with up to 60W of power

NOTE: In order for a USB-C DisplayPort input to charge the connected AV source, the DM Essentials transmitter must be powered by the included power pack. If the device is powered by a remote DM Essentials receiver or DMPS Essentials switcher, no charging capability is provided by the USB-C input.

- ⑤ **Ground:** Chassis ground lug

HD-TXU-4KZ-111-E

The front and rear panels of the HD-TXU-4KZ-111-E transmitter provide connectors, controls, and indicators as discussed in the following sections.

Front Panel

The following illustration shows the front panel of the HD-TXU-4KZ-111-E transmitter.

HD-TXU-4KZ-111-E Transmitter, Front Panel

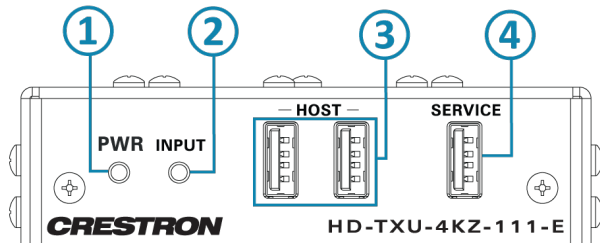

- ① **PWR LED:** Lights to indicate that power is being applied to the device. Amber indicates that the device is booting. Green indicates that the device is operational.
- ② **INPUT LED:** Green LED, lights to indicate that the device is receiving a DisplayPort over USB-C (DisplayPort Alt Mode) input signal
- ③ **HOST Ports:** USB Type-A connectors, female;
USB 2.0 host ports;
USB signal extender ports for connection to USB mice, keyboards, or other USB 2.0 peripheral devices;
Available Power: 500 mA @ 5VDC per port
- ④ **SERVICE:** USB 2.0 Type-A connector, female;
Used for firmware loading, configuration management, or as a USB host port for one TT-100 series cable caddy (sold separately);
Can also provide up to 5V 500 mA power to a USB powered device

Rear Panel

The following illustration shows the rear panel of the HD-TXU-4KZ-111-E transmitter.

HD-TXU-4KZ-111-E Transmitter, Rear Panel

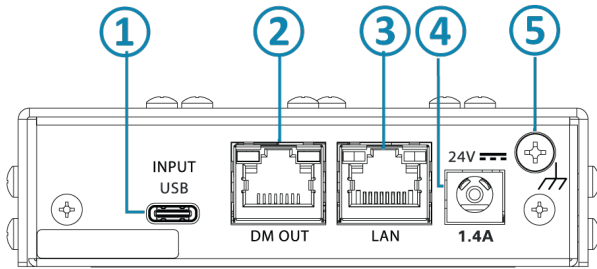

- ① **USB INPUT Port:** USB Type-C® connector, female;
Digital video/audio input using DisplayPort Alt Mode (CBL-USB3G1-C-C-6 and CBL-USB3G2-C-C-3 cables sold separately);
USB 2.0 data support
- ② **DM OUT Port:** 8-pin RJ-45 yellow connector, female, shielded;
DM Essentials output port for connection to the DM Essentials input port of a DM Essentials HD-RXU-4KZ Series receiver;
Green LED indicates that a DM Essentials link is established;
Flashing amber LED indicates non-HDCP video, and solid amber indicates HDCP video
- ③ **LAN Port:** 8-pin RJ-45 connector, female;
100BASE-TX/1000BASE-T Ethernet port;
Passes Ethernet signal over the DM Essentials connection to an HD-RXU-4KZ-101-E receiver;
Green LED indicates that a 100 Mbps link is established,
Solid amber indicates that a 1000 Mbps link is established,
Flashing amber indicates 1000 Mbps Ethernet activity
- ④ **24V 1.4A Power Connector:** 2.1 x 5.5 mm DC power connector;
24VDC power input;
PW-2420RU power pack included
- ⑤ **Ground:** Chassis ground lug

HD-TXU-4KZ-211

The front and rear panels of the HD-TXU-4KZ-211 transmitter provide connectors, controls, and indicators as discussed in the following sections.

Front Panel

The following illustration shows the front panel of the HD-TXU-4KZ-211 transmitter.

HD-TXU-4KZ-211 Transmitter, Front Panel

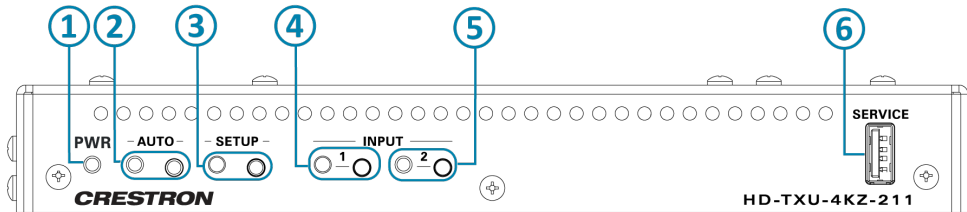

- ① **PWR LED:** Lights to indicate that power is being applied to the device. Amber indicates that the device is booting. Green indicates that the device is operational.
- ② **AUTO LED and Push Button:** Green LED, lights to indicate that automatic switching of inputs is enabled;
Push button, enables or disables automatic switching of inputs
- ③ **SETUP LED and Push Button:** Red LED, lights to indicate that the SETUP push button is pressed;
Push button, enables Ethernet setup
- ④ **INPUT 1 LED and Push Button:** LED, green indicates that the USB-C DisplayPort input is routed to the output, and amber indicates that a source is detected but is not routed to the output;
Push button, enables manual selection of USB-C DisplayPort input
- ⑤ **INPUT 2 LED and Push Button:** LED, green indicates that the HDMI input is routed to the output, and amber indicates that a source is detected but is not routed to the output;
Push button, enables manual selection of HDMI input
- ⑥ **SERVICE:** USB 2.0 Type-A connector, female;
Used for firmware loading and configuration management;
Can also provide up to 5V 500 mA power to a USB powered device

Rear Panel

The following illustration shows the rear panel of the HD-TXU-4KZ-211 transmitter.

HD-TXU-4KZ-211 Transmitter, Rear Panel

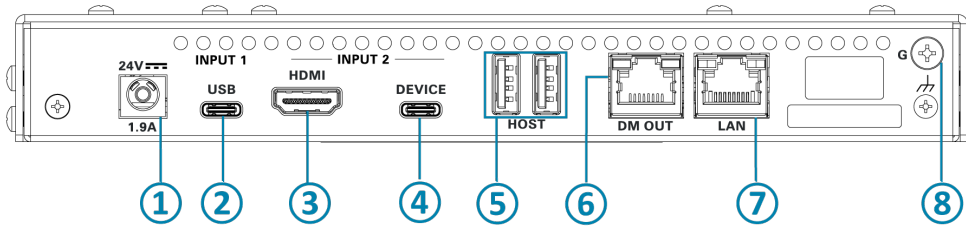

- ① **24V 1.9A Power Connector:** 2.1 x 5.5 mm DC power connector;
24VDC power input;
PW-2420RU power pack included
- ② **USB INPUT 1 Port:** USB Type-C® connector, female;
Digital video/audio input using DisplayPort Alt Mode (CBL-USB3G1-C-C-6 and CBL-USB3G2-C-C-3 cables sold separately);
USB 2.0 data support
- ③ **HDMI INPUT 2 Port:** HDMI Type A connector, female;
HDMI digital video/audio input;
DVI and Dual-Mode DisplayPort™ interface compatible with appropriate adapter or interface cable (CBL-HD-DVI interface cables sold separately)
- ④ **DEVICE INPUT 2 Port:** USB Type-C® connector, female;
USB 2.0 device port associated with HDMI input for AV sources that require USB 2.0 support;
USB signal extender port for connection to a computer or other USB 2.0 host
- ⑤ **HOST Ports:** USB Type-A connectors, female;
USB 2.0 host ports;
USB signal extender ports for connection to USB mice, keyboards, or other USB 2.0 peripheral devices;
Available Power: 500 mA @ 5VDC per port
- ⑥ **DM OUT Port:** 8-pin RJ-45 yellow connector, female, shielded;
DM Essentials output port for connection to the DM Essentials input port of a DM Essentials HD-RXU-4KZ Series receiver;
Green LED indicates that a DM Essentials link is established;
Flashing amber LED indicates non-HDCP video, and solid amber indicates HDCP video
- ⑦ **LAN Port:** 8-pin RJ-45 connector, female;
100BASE-TX/1000BASE-T Ethernet port for device configuration and management;
Green LED indicates that a 100 Mbps link is established,
Solid amber indicates that a 1000 Mbps link is established,
Flashing amber indicates 1000 Mbps Ethernet activity
- ⑧ **Ground:** Chassis ground lug

HD-TXU-4KZ-211-CHGR

The front and rear panels of the HD-TXU-4KZ-211-CHGR transmitter provide connectors, controls, and indicators as discussed in the following sections.

Front Panel

The following illustration shows the front panel of the HD-TXU-4KZ-211-CHGR transmitter.

HD-TXU-4KZ-211-CHGR Transmitter, Front Panel

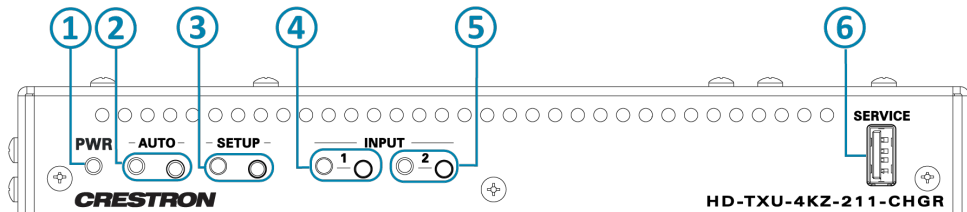

- ① **PWR LED:** Lights to indicate that power is being applied to the device. Amber indicates that the device is booting. Green indicates that the device is operational.
- ② **AUTO LED and Push Button:** Green LED, lights to indicate that automatic switching of inputs is enabled;
Push button, enables or disables automatic switching of inputs
- ③ **SETUP LED and Push Button:** Red LED, lights to indicate that the SETUP push button is pressed;
Push button, enables Ethernet setup
- ④ **INPUT 1 LED and Push Button:** LED, green indicates that the USB-C DisplayPort input is routed to the output, and amber indicates that a source is detected but is not routed to the output;
Push button, enables manual selection of USB-C DisplayPort input
- ⑤ **INPUT 2 LED and Push Button:** LED, green indicates that the HDMI input is routed to the output, and amber indicates that a source is detected but is not routed to the output;
Push button, enables manual selection of HDMI input
- ⑥ **SERVICE:** USB 2.0 Type-A connector, female;
Used for firmware loading and configuration management;
Can also provide up to 5V 500 mA power to a USB powered device

Rear Panel

The following illustration shows the rear panel of the HD-TXU-4KZ-211-CHGR transmitter.

HD-TXU-4KZ-211-CHGR Transmitter, Rear Panel

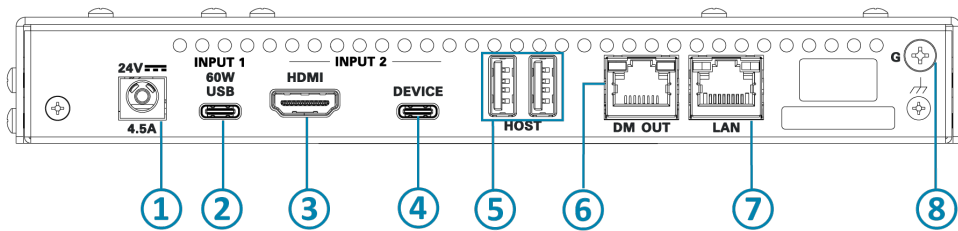

- ① **24V 4.5A Power Connector:** 2.1 x 5.5 mm DC power connector;
24VDC power input;
PW-2475DU power pack included
- ② **60W USB INPUT 1 Port:** USB Type-C® connector, female;
Digital video/audio input using DisplayPort Alt Mode;
USB 2.0 data support;
Can also charge connected AV source with up to 60W of power

NOTE: In order for the USB-C DisplayPort input to charge the connected AV source, the HD-TXU-4KZ-211-CHGR must be powered by the included power pack. If the HD-TXU-4KZ-211-CHGR is powered by a remote DM Essentials receiver, no charging capability is provided by the USB-C input.

- ③ **HDMI INPUT 2 Port:** HDMI Type A connector, female;
HDMI digital video/audio input;
DVI and Dual-Mode DisplayPort™ interface compatible with appropriate adapter or interface cable (CBL-HD-DVI interface cables sold separately)
- ④ **DEVICE INPUT 2 Port:** USB Type-C® connector, female;
USB 2.0 device port associated with HDMI input for AV sources that require USB 2.0 support;
USB signal extender port for connection to a computer or other USB 2.0 host
- ⑤ **HOST Ports:** USB Type-A connectors, female;
USB 2.0 host ports;
USB signal extender ports for connection to USB mice, keyboards, or other USB 2.0 peripheral devices;
Available Power: 500 mA @ 5VDC per port
- ⑥ **DM OUT Port:** 8-pin RJ-45 yellow connector, female, shielded;
DM Essentials output port for connection to the DM Essentials input port of a DM Essentials HD-RXU-4KZ Series receiver;
Green LED indicates that a DM Essentials link is established;
Flashing amber LED indicates non-HDCP video, and solid amber indicates HDCP video

- ⑦ **LAN Port:** 8-pin RJ-45 connector, female;
100BASE-TX/1000BASE-T Ethernet port for device configuration and management;
Green LED indicates that a 100 Mbps link is established,
Solid amber indicates that a 1000 Mbps link is established,
Flashing amber indicates 1000 Mbps Ethernet activity
- ⑧ **Ground:** Chassis ground lug

Wall Plate Transmitters

This section provides information about the front and rear of the [HD-TX\(A\)\(C\)-4KZ-1x1-1G Series](#), [HD-TX-4KZ-211-2G](#), and [HD-TXU-4KZ-111-2G](#) wall plate transmitters.

HD-TX(A)(C)-4KZ-1x1-1G Series

HD-TX(A)(C)-4KZ-1x1-1G Series transmitters consist of the following:

- HD-TX-4KZ-101-1G
- HD-TXA-4KZ-101-1G
- HD-TXC-4KZ-101-1G
- HD-TX-4KZ-111-1G

The front and rear of the HD-TX(A)(C)-4KZ-1x1-1G Series transmitters provide connectors, controls, and indicators as discussed in the following sections.

Front View

The following illustration shows the front of the HD-TX(A)(C)-4KZ-1x1-1G Series transmitters.

HD-TX(A)(C)-4KZ-1x1-1G Series Transmitters, Front

**HD-TXA-4KZ-101-1G,
Front**

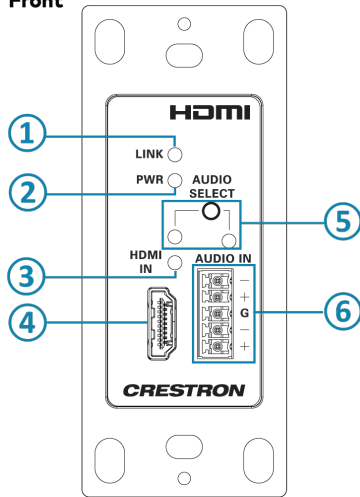

**HD-TXC-4KZ-101-1G,
Front**

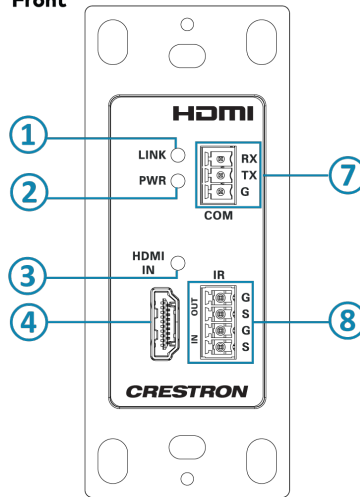

**HD-TX-4KZ-101-1G,
Front**

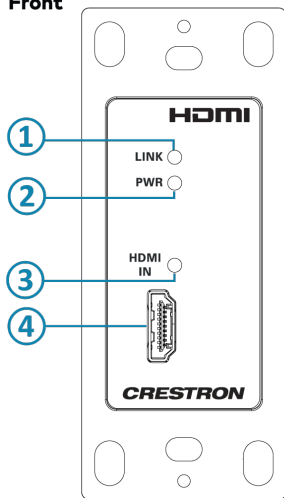

**HD-TX-4KZ-111-1G,
Front**

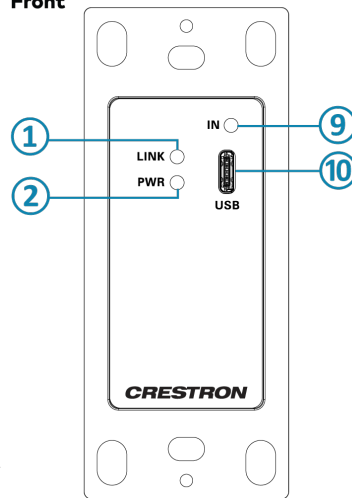

- ① **LINK LED:** Green LED, indicates that a DM Essentials link is established
- ② **PWR LED:** Lights to indicate that power is being applied to the device. Amber indicates that the device is booting. Green indicates that the device is operational.
- ③ **HDMI IN LED:** Green LED, indicates that the device is receiving an HDMI signal
- ④ **HDMI IN Port:** HDMI Type A connector, female;
HDMI digital video/audio input;
DVI and Dual-Mode DisplayPort™ interface compatible with appropriate adapter or interface cable (CBL-HD-DVI interface cables sold separately)

- ⑤ **AUDIO SELECT:** Push button, enables selection of HDMI or analog audio
AUDIO, HDMI IN LED: Green LED, indicates that HDMI audio is selected
AUDIO IN LED: Green LED, indicates that analog audio is selected
- ⑥ **AUDIO IN Port:** 5-pin 3.5 mm detachable terminal block;
Balanced/unbalanced stereo line-level audio input;
Input Impedance: 24k Ohms balanced/unbalanced;
Maximum Input Level: 4 Vrms balanced, 2 Vrms unbalanced
- ⑦ **COM Port:** 3-pin 3.5 mm detachable terminal block;
Bidirectional RS-232 port;
Passes RS-232 TD/RD data to/from the COM port on a DM Essentials receiver;
Supports up to 115.2k baud
- ⑧ **IR IN/OUT Ports:** 4-pin 3.5 mm detachable terminal block;
Comprised of (1) IR input port and (1) IR output port;
IR IN passes the IR input signal to the IR OUT port on the DM Essentials receiver;
IR OUT transmits the IR signal from the IR IN port on the DM Essentials receiver;
Supports IR up to 60 kHz
- ⑨ **USB IN LED:** Green LED, lights to indicate that the device is receiving a DisplayPort over USB-C (DisplayPort Alt Mode) input signal
- ⑩ **USB Port:** USB Type-C® connector, female;
Digital video/audio input using DisplayPort Alt Mode (CBL-USB3G1-C-C-6 and CBL-USB3G2-C-C-3 cables sold separately)

Rear View

The following illustration shows the rear of the HD-TX(A)(C)-4KZ-1x1-1G Series transmitters.

HD-TX(A)(C)-4KZ-1x1-1G Series Transmitters, Rear

**1G Wall Plate Transmitter,
Rear**

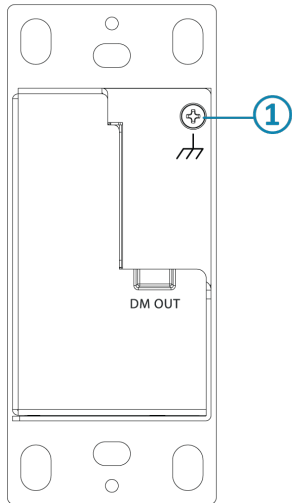

**1G Wall Plate Transmitter,
Rear, Top View**

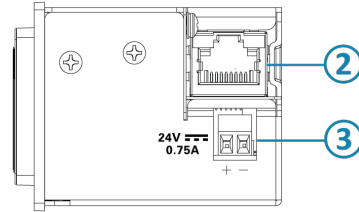

- ① **Ground:** Chassis ground lug
- ② **DM OUT Port:** 8-pin RJ-45 yellow connector, female, shielded;
DM Essentials output port for connection to the DM Essentials input port of a DM Essentials receiver or DMPS Essentials switcher;
Green LED indicates that a DM Essentials link is established;
Flashing amber LED indicates non-HDCP video, and solid amber indicates HDCP video
- ③ **24V 0.75A Power Connector:** 2-pin 3.5 mm detachable terminal block;
24VDC power input;
Power pack sold separately, required only if the wall plate transmitter is used with a wall plate receiver

HD-TX-4KZ-211-2G

The front and rear of the HD-TX-4KZ-211-2G transmitter provide connectors, controls, and indicators as discussed in the following sections.

Front View

The following illustration shows the front of the HD-TX-4KZ-211-2G.

HD-TX-4KZ-211-2G, Front

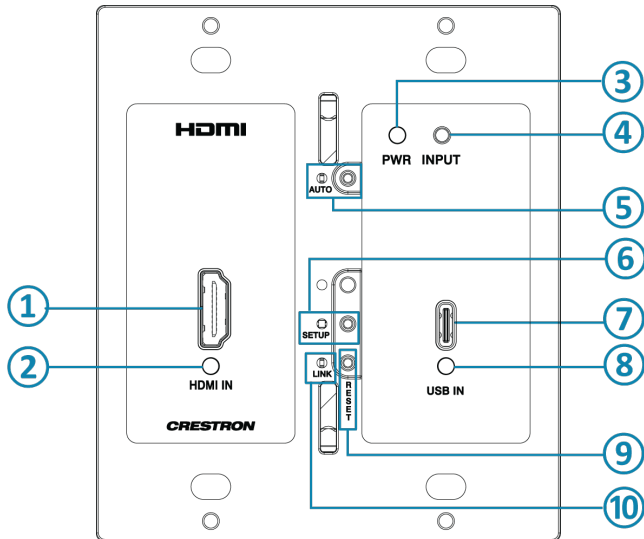

- ① **HDMI IN Port:** HDMI Type A connector, female;
HDMI digital video/audio input;
DVI and Dual-Mode DisplayPort™ interface compatible with appropriate adapter or interface cable (CBL-HD-DVI interface cables sold separately)
- ② **HDMI IN LED:** Green LED, indicates that the device is receiving an HDMI signal
- ③ **PWR LED:** Lights to indicate that power is being applied to the device. Amber indicates that the device is booting. Green indicates that the device is operational.
- ④ **INPUT Push Button:** Enables manual selection of HDMI or USB-C DisplayPort input
- ⑤ **AUTO LED and Push Button:** Green LED, lights to indicate that automatic switching of inputs is enabled;
Push button, enables or disables automatic switching of inputs
- ⑥ **SETUP LED and Push Button:** Red LED, lights to indicate that the SETUP push button is pressed;
Push button, enables Ethernet setup, applicable only when the device is used with a DMPS Essentials switcher
- ⑦ **USB IN Port:** USB Type-C® connector, female;
Digital video/audio input using DisplayPort Alt Mode (CBL-USB3G1-C-C-6 and CBL-USB3G2-C-C-3 cables sold separately)

- ⑧ **USB IN LED:** Green LED, lights to indicate that the device is receiving a DisplayPort over USB-C (DisplayPort Alt Mode) input signal
- ⑨ **RESET Push Button:** Restores factory default settings
- ⑩ **LINK LED:** Green LED, indicates that a DM Essentials link is established

Rear View

The following illustration shows the rear of the HD-TX-4KZ-211-2G.

HD-TX-4KZ-211-2G Transmitter, Rear

HD-TX-4KZ-211-2G, Rear

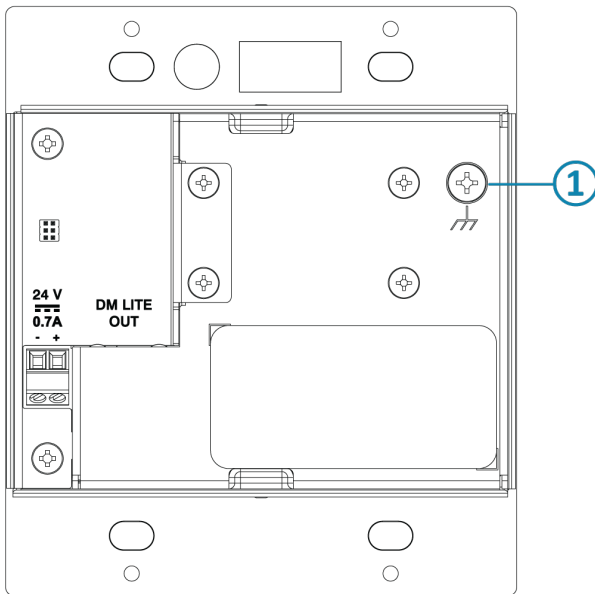

HD-TX-4KZ-211-2G, Rear, Top View

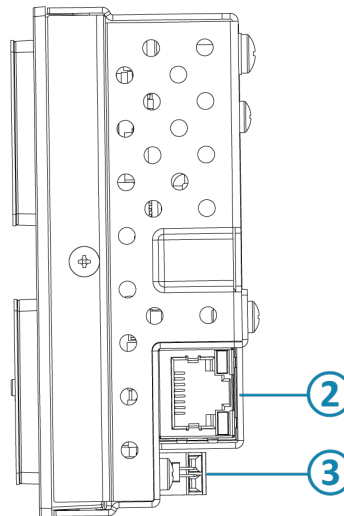

- ① **Ground:** Chassis ground lug
- ② **DM OUT Port:** 8-pin RJ-45 yellow connector, female, shielded; DM Essentials output port for connection to the DM Essentials input port of a DM Essentials receiver or DMPS Essentials switcher; Green LED indicates that a DM Essentials link is established; Flashing amber LED indicates non-HDCP video, and solid amber indicates HDCP video
- ③ **24V 0.7A Power Connector:** 2-pin 3.5 mm detachable terminal block; 24VDC power input; Power pack sold separately, required only if the wall plate transmitter is used with a wall plate receiver

HD-TXU-4KZ-111-2G

The front and rear of the HD-TXU-4KZ-111-2G transmitter provide connectors, controls, and indicators as discussed in the following sections.

Front View

The following illustration shows the front of the HD-TXU-4KZ-111-2G.

HD-TXU-4KZ-111-2G, Front

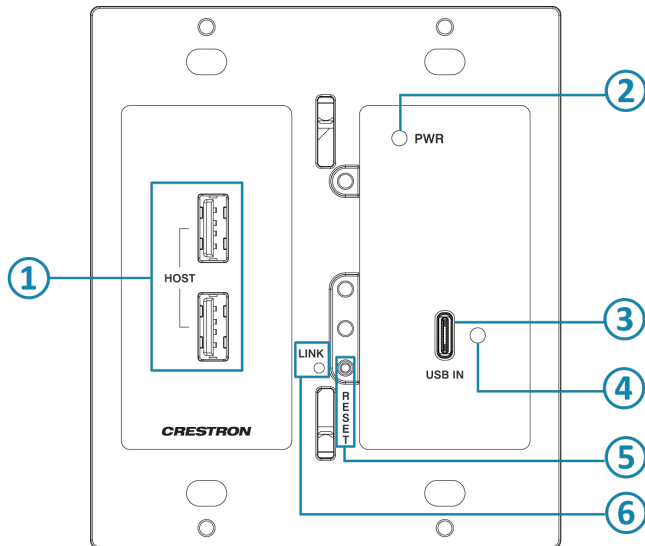

- ① **HOST Ports:** USB Type-A connectors, female;
USB 2.0 host ports;
USB signal extender ports for connection to USB mice, keyboards, or other USB 2.0 peripheral devices;
Available Power: 500 mA @ 5VDC per port
- ② **PWR LED:** Lights to indicate that power is being applied to the device. Amber indicates that the device is booting. Green indicates that the device is operational.
- ③ **USB IN Port:** USB Type-C® connector, female;
Digital video/audio input using DisplayPort Alt Mode (CBL-USB3G1-C-C-6 and CBL-USB3G2-C-C-3 cables sold separately);
USB 2.0 data support
- ④ **USB IN LED:** Green LED, lights to indicate that the device is receiving a DisplayPort over USB-C (DisplayPort Alt Mode) input signal
- ⑤ **RESET Push Button:** Restores factory default settings
- ⑥ **LINK LED:** Green LED, indicates that a DM Essentials link is established

Rear View

The following illustration shows the rear of the HD-TXU-4KZ-111-2G.

HD-TXU-4KZ-111-2G, Rear

**HD-TXU-4KZ-111-2G,
Rear**

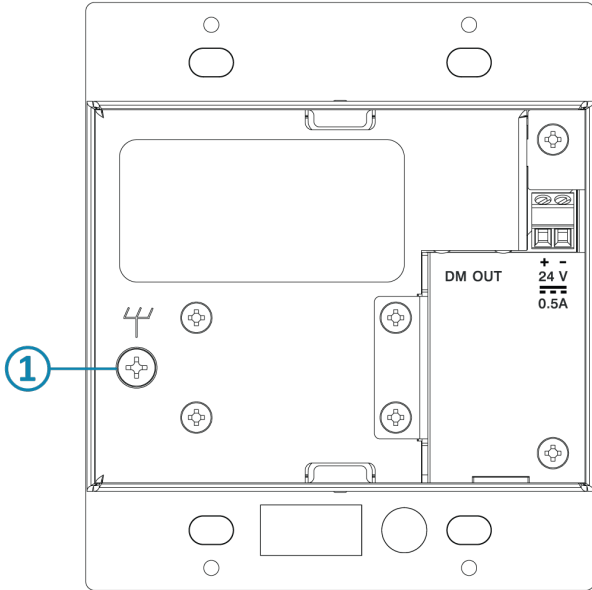

**HD-TXU-4KZ-111-2G,
Rear, Top View**

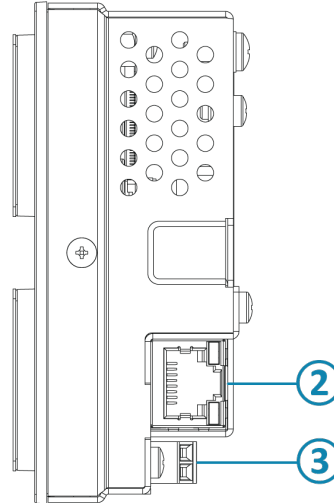

- ① **Ground:** Chassis ground lug
- ② **DM OUT Port:** 8-pin RJ-45 yellow connector, female, shielded;
DM Essentials output port for connection to the DM Essentials input port of a DM Essentials HD-RXU-4KZ Series receiver;
Green LED indicates that a DM Essentials link is established;
Flashing amber LED indicates non-HDCP video, and solid amber indicates HDCP video
- ③ **24V 0.5A Power Connector:** 2-pin 3.5 mm detachable terminal block;
24VDC power input;
Power pack sold separately, required only if the wall plate transmitter is used with a wall plate receiver

Surface-Mountable Receivers

This section provides information about the front and rear panels of the [HD-RX\(A\)\(C\)\(CA\)-4KZ-101 Series](#), [HD-RXU-4KZ-101-E](#), and [HD-RXU-4KZ-202](#) surface-mountable receivers.

HD-RX(A)(C)(CA)-4KZ-101 Series

HD-RX(A)(C)(CA)-4KZ-101 Series receivers consist of the following:

- HD-RX-4KZ-101
- HD-RXA-4KZ-101
- HD-RXC-4KZ-101
- HD-RXCA-4KZ-101

Front Panel

The following illustration shows the front panel of each of the HD-RX(A)(C)(CA)-4KZ-101 Series receivers.

HD-RX(A)(C)(CA)-4KZ-101 Series Receivers, Front Panel

HD-RXCA-4KZ-101 Front Panel

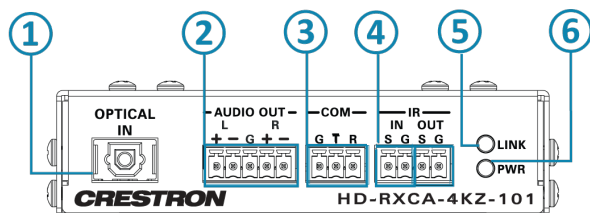

HD-RXA-4KZ-101 Front Panel

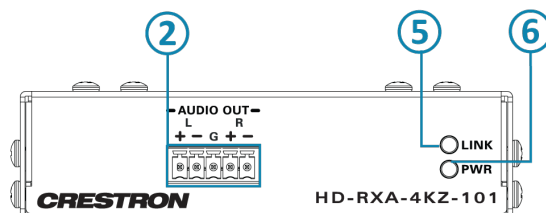

HD-RXC-4KZ-101 Front Panel

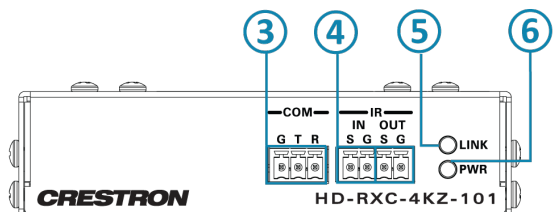

HD-RX-4KZ-101 Front Panel



- ① **OPTICAL IN Port:** JIS F05 female, TOSLINK optical fiber connector;
S/PDIF optical digital audio input, functional only when the HD-RXCA-4KZ-101 receiver is used with the HD-TXCA-4KZ-101 transmitter
- ② **AUDIO OUT Port:** 5-pin 3.5 mm detachable terminal block;
Balanced/unbalanced stereo line-level audio output;
Output Impedance: 200 Ohms balanced, 100 Ohms unbalanced
Maximum Input Level: 4 Vrms balanced, 2 Vrms unbalanced

- ③ **COM Port:** 3-pin 3.5 mm detachable terminal block;
Bidirectional RS-232 port;
Passes RS-232 TD/RD data to/from the COM port on a DM Essentials transmitter;
Supports up to 115.2k baud
- ④ **IR IN/OUT Ports:** 4-pin 3.5 mm detachable terminal block;
Comprised of (1) IR input port and (1) IR output port;
IR IN passes the IR input signal to the IR OUT port on the DM Essentials transmitter;
IR OUT transmits the IR signal from the IR IN port on the DM Essentials transmitter;
Supports IR up to 60 kHz
- ⑤ **LINK LED:** Green LED, indicates that a DM Essentials link is established
- ⑥ **PWR LED:** Lights to indicate that power is being applied to the device. Amber indicates that the device is booting. Green indicates that the device is operational.

Rear Panel

The following illustration shows the rear panel of the HD-RX(A)(C)(CA)-4KZ-101 Series receivers.

HD-RX(A)(C)(CA)-4KZ-101 Series Receivers, Rear Panel

HD-RXCA-4KZ-101, HD-RXA-4KZ-101, HD-RXC-4KZ-101, and HD-RX-4KZ-101 Rear Panel

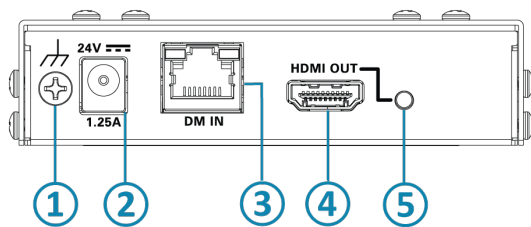

- ① **Ground:** Chassis ground lug
- ② **24V 1.25A Power Connector:** 2.1 x 5.5 mm DC power connector;
24VDC power input;
PW-2420RU power pack included
- ③ **DM IN Port:** 8-pin RJ-45 yellow connector, female, shielded;
DM Essentials input port for connection to the DM Essentials output port of a DM Essentials transmitter or DMPS Essentials switcher;
Green LED indicates that a DM Essentials link is established;
Flashing amber LED indicates non-HDCP video, and solid amber indicates HDCP video
- ④ **HDMI OUT Port:** HDMI Type A connector, female;
HDMI digital video/audio output;
DVI compatible with appropriate adapter or interface cable (CBL-HD-DVI interface cables sold separately)
- ⑤ **HDMI OUT LED:** Green LED, indicates that the device is transmitting an HDMI signal

HD-RXU-4KZ-101-E

The front and rear panels of the HD-RXU-4KZ-101-E receiver provide connectors, controls, and indicators as discussed in the following sections.

Front Panel

The following illustration shows the front panel of the HD-RXU-4KZ-101-E receiver.

HD-RXU-4KZ-101-E Receiver, Front Panel

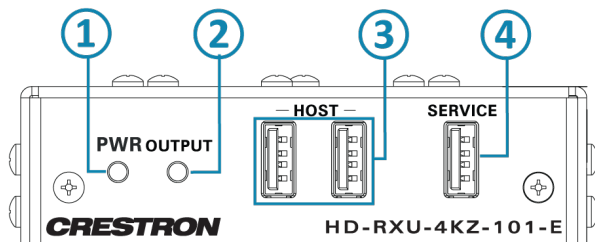

- ① **PWR LED:** Lights to indicate that power is being applied to the device. Amber indicates that the device is booting. Green indicates that the device is operational.
- ② **OUTPUT LED:** Green LED, indicates that the device is transmitting an HDMI signal
- ③ **HOST Ports:** USB Type-A connectors, female;
USB 2.0 host ports;
USB signal extender ports for connection to USB mice, keyboards, or other USB 2.0 peripheral devices;
Available Power: 500 mA @ 5VDC per port
- ④ **SERVICE:** USB 2.0 Type-A connector, female;
Used for firmware loading, configuration management, or as a USB host port for one TT-100 series cable caddy (sold separately);
Can also provide up to 5V 500 mA power to a USB powered device

Rear Panel

The following illustration shows the rear panel of the HD-RXU-4KZ-101-E receiver.

HD-RXU-4KZ-101-E Receiver, Rear Panel

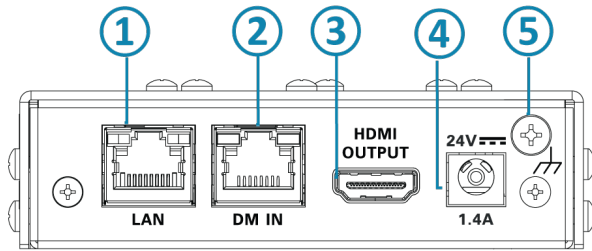

- ① **LAN Port:** 8-pin RJ-45 connector, female;
100BASE-TX/1000BASE-T Ethernet port;
Receives Ethernet signal from an HD-TXU-4KZ-111-E transmitter over the DM Essentials connection;
Green LED indicates that a 100 Mbps link is established,
Solid amber indicates that a 1000 Mbps link is established,
Flashing amber indicates 1000 Mbps Ethernet activity
- ② **DM IN Port:** 8-pin RJ-45 yellow connector, female, shielded;
DM Essentials input port for connection to the DM Essentials output port of a DM Essentials HD-TXU-4KZ Series transmitter;
Green LED indicates that a DM Essentials link is established;
Flashing amber LED indicates non-HDCP video, and solid amber indicates HDCP video
- ③ **HDMI OUTPUT Port:** HDMI Type A connector, female;
HDMI digital video/audio output;
DVI compatible with appropriate adapter or interface cable (CBL-HD-DVI interface cables sold separately)
- ④ **24V 1.4A Power Connector:** 2.1 x 5.5 mm DC power connector;
24VDC power input;
PW-2420RU power pack included
- ⑤ **Ground:** Chassis ground lug

HD-RXU-4KZ-202

The front and rear panels of the HD-RXU-4KZ-202 receiver provide connectors, controls, and indicators as discussed in the following sections.

Front Panel

The following illustration shows the front panel of the HD-RXU-4KZ-202 receiver.

HD-RXU-4KZ-202 Receiver, Front Panel

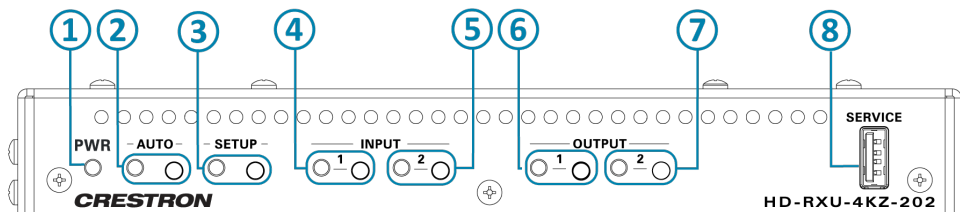

- ① **PWR LED:** Lights to indicate that power is being applied to the device. Amber indicates that the device is booting. Green indicates that the device is operational.
- ② **AUTO LED and Push Button:** Green LED, lights to indicate that automatic switching of inputs is enabled;
Push button, enables or disables automatic switching of inputs
- ③ **SETUP LED and Push Button:** Red LED, lights to indicate that the SETUP push button is pressed;
Push button, enables Ethernet setup
- ④ **INPUT 1 LED and Push Button:** LED, green indicates that the HDMI input is routed to an output, and amber indicates that a source is detected but is not routed to an output;
Push button, enables manual selection of HDMI input
- ⑤ **INPUT 2 LED and Push Button:** LED, green indicates that the DM Essentials input is routed to an output, and amber indicates that a source is detected but is not routed to an output;
Push button, enables manual selection of DM Essentials input
- ⑥ **OUTPUT 1 LED and Push Button:** LED, green indicates that a display or other destination device is detected and HDMI output 1 is transmitting video. Amber indicates that a display or other destination device is detected but no video is routed to the output.
Push button, enables manual selection of HDMI output 1
- ⑦ **OUTPUT 2 LED and Push Button:** LED, green indicates that a display or other destination device is detected and HDMI output 2 is transmitting video. Amber indicates that a display or other destination device is detected but no video is routed to the output.
Push button, enables manual selection of HDMI output 2.
- ⑧ **SERVICE:** USB 2.0 Type-A connector, female;
Used for firmware loading and configuration management;
Can also provide up to 5V 500 mA power to a USB powered device

Rear Panel

The following illustration shows the rear panel of the HD-RXU-4KZ-202 receiver.

HD-RXU-4KZ-202 Receiver, Rear Panel

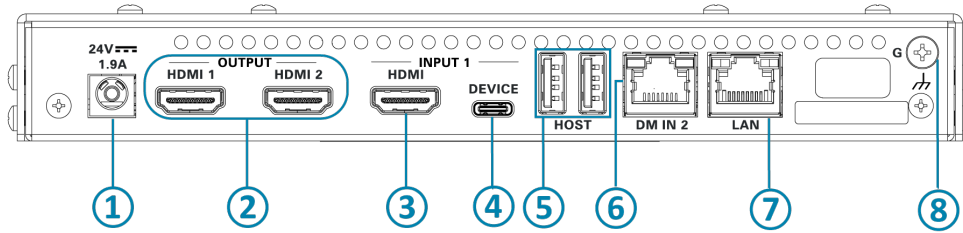

- ① **24V 1.9A Power Connector:** 2.1 x 5.5 mm DC power connector;
24VDC power input;
PW-2420RU power pack included
- ② **HDMI OUTPUT 1-2 Ports:** HDMI Type A connectors, female;
HDMI digital video/audio outputs;
DVI compatible with appropriate adapter or interface cable (CBL-HD-DVI interface cables sold separately)
- ③ **HDMI INPUT 1 Port:** HDMI Type A connector, female;
HDMI digital video/audio input;
DVI and Dual-Mode DisplayPort™ interface compatible with appropriate adapter or interface cable (CBL-HD-DVI interface cables sold separately)
- ④ **DEVICE INPUT 1 Port:** USB Type-C® connector, female;
USB 2.0 device port associated with HDMI input for AV sources that require USB 2.0 support;
USB signal extender port for connection to a computer or other USB 2.0 host
- ⑤ **HOST Ports:** USB Type-A connectors, female;
USB 2.0 host ports;
USB signal extender ports for connection to USB mice, keyboards, or other USB 2.0 peripheral devices;
Available Power: 500 mA @ 5VDC per port
- ⑥ **DM IN 2 Port:** 8-pin RJ-45 yellow connector, female, shielded;
DM Essentials input port for connection to the DM Essentials output port of a DM Essentials HD-TXU-4KZ Series transmitter;
Green LED indicates that a DM Essentials link is established;
Flashing amber LED indicates non-HDCP video, and solid amber indicates HDCP video.
- ⑦ **LAN Port:** 8-pin RJ-45 connector, female;
100BASE-TX/1000BASE-T Ethernet port for device configuration and management;
Green LED indicates that a 100 Mbps link is established,
Solid amber indicates that a 1000 Mbps link is established,
Flashing amber indicates 1000 Mbps Ethernet activity
- ⑧ **Ground:** Chassis ground lug

Wall Plate Receivers

This section provides information about the front and rear of the [HD-RX\(C\)-4KZ-101-1G Series](#) and [HD-RXU-4KZ-101-2G](#) wall plate receivers.

HD-RX(C)-4KZ-101-1G Series

HD-RX(C)-4KZ-101-1G Series receivers consist of the following:

- HD-RX-4KZ-101-1G-B
- HD-RXC-4KZ-101-G-B

Front View

The following illustration shows the front of the HD-RX(C)-4KZ-101-1G Series receivers.

HD-RX(C)-4KZ-101-1G Series Receivers, Front

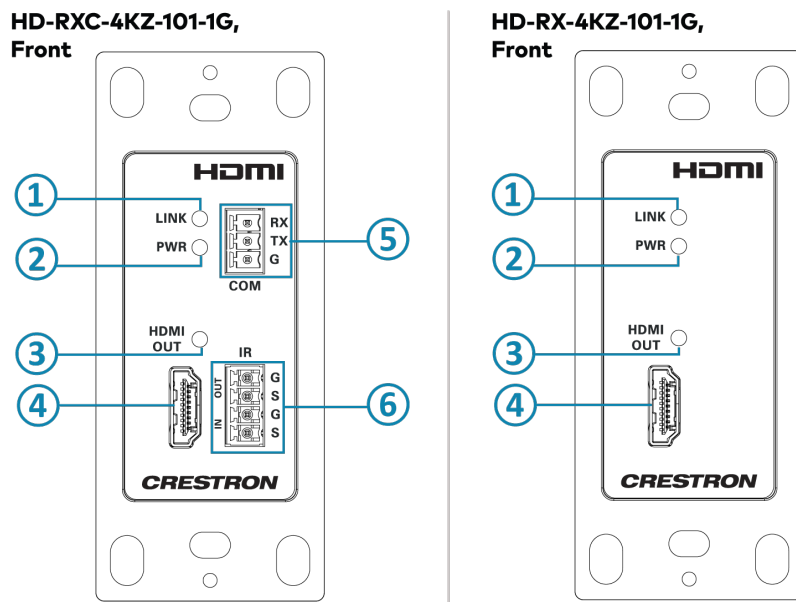

- ① **LINK LED:** Green LED, indicates that a DM Essentials link is established
- ② **PWR LED:** Lights to indicate that power is being applied to the device. Amber indicates that the device is booting. Green indicates that the device is operational.
- ③ **HDMI OUT LED:** Green LED, indicates that the device is transmitting an HDMI signal
- ④ **HDMI OUT Port:** HDMI Type A connector, female;
HDMI digital video/audio output;
DVI compatible with appropriate adapter or interface cable (CBL-HD-DVI interface cables sold separately)
- ⑤ **COM Port:** 3-pin 3.5 mm detachable terminal block;
Bidirectional RS-232 port;
Passes RS-232 TD/RD data to/from the COM port on a DM Essentials transmitter;
Supports up to 115.2k baud

- ⑥ **IR IN/OUT Ports:** 4-pin 3.5 mm detachable terminal block;
Comprised of (1) IR input port and (1) IR output port;
IR IN passes the IR input signal to the IR OUT port on the DM Essentials transmitter;
IR OUT transmits the IR signal from the IR IN port on the DM Essentials transmitter;
Supports IR up to 60 kHz

Rear View

The following illustration shows the rear of the HD-RX(C)-4KZ-101-1G Series receivers.

HD-RX(C)-4KZ-101-1G Series Receivers, Rear

**1G Wall Plate Receiver,
Rear**

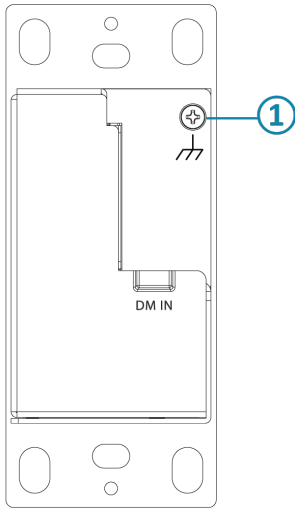

**1G Wall Plate Receiver,
Rear, Top View**

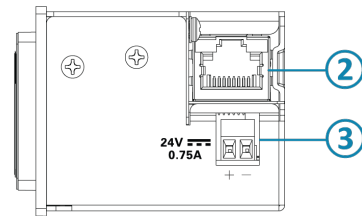

- ① **Ground:** Chassis ground lug
- ② **DM IN Port:** 8-pin RJ-45 yellow connector, female, shielded;
DM Essentials input port for connection to the DM Essentials output port of a DM Essentials transmitter or DMPS Essentials switcher;
Green LED indicates that a DM Essentials link is established;
Flashing amber LED indicates non-HDCP video, and solid amber indicates HDCP video
- ③ **24V 0.75A Power Connector:** 2-pin 3.5 mm detachable terminal block;
24VDC power input;
Power pack sold separately, required only if the wall plate receiver is used with a wall plate transmitter

HD-RXU-4KZ-101-2G

The front and rear of the HD-RXU-4KZ-101-2G receiver provide connectors, controls, and indicators as discussed in the following sections.

Front View

The following illustration shows the front of the HD-RXU-4KZ-101-2G receiver.

HD-RXU-4KZ-101-2G Receiver, Front

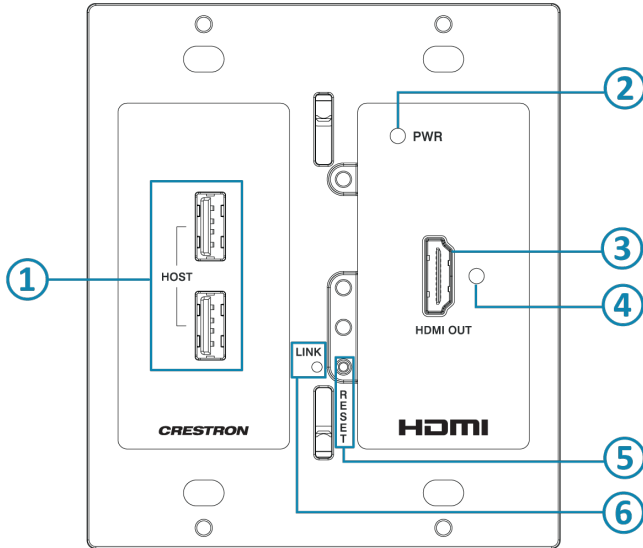

- ① **HOST Ports:** USB Type-A connectors, female;
USB 2.0 host ports;
USB signal extender ports for connection to USB mice, keyboards, or other USB 2.0 peripheral devices;
Available Power: 500 mA @ 5VDC per port
- ② **PWR LED:** Lights to indicate that power is being applied to the device. Amber indicates that the device is booting. Green indicates that the device is operational.
- ③ **HDMI OUT Port:** HDMI Type A connector, female;
HDMI digital video/audio output;
DVI compatible with appropriate adapter or interface cable (CBL-HD-DVI interface cables sold separately)
- ④ **HDMI OUT LED:** Green LED, indicates that the device is transmitting an HDMI signal
- ⑤ **RESET Push Button:** Restores factory default settings
- ⑥ **LINK LED:** Green LED, indicates that a DM Essentials link is established

Rear View

The following illustration shows the rear of the HD-RXU-4KZ-101-2G receiver.

HD-RXU-4KZ-101-2G Receiver, Rear

**HD-RXU-4KZ-101-2G,
Rear**

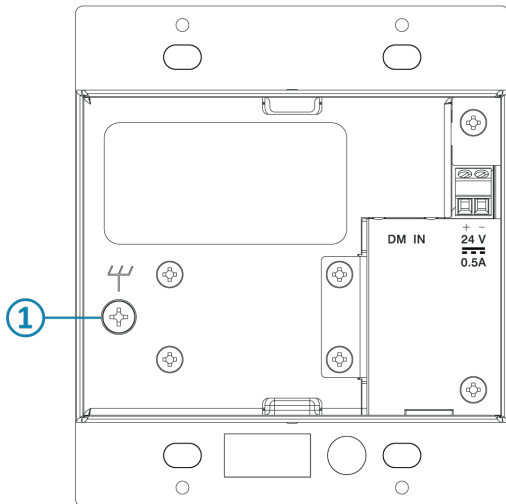

**HD-RXU-4KZ-101-2G,
Rear, Top View**

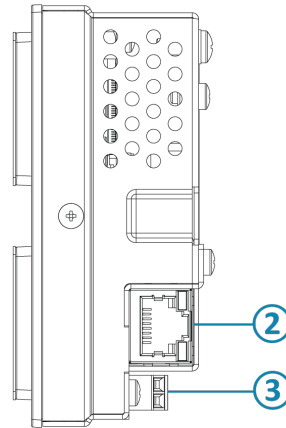

- ① **Ground:** Chassis ground lug
- ② **DM IN Port:** 8-pin RJ-45 yellow connector, female, shielded;
DM Essentials input port for connection to the DM Essentials output port of a DM Essentials HD-TXU-4KZ Series transmitter;
Green LED indicates that a DM Essentials link is established;
Flashing amber LED indicates non-HDCP video, and solid amber indicates HDCP video
- ③ **24V 0.5A Power Connector:** 2-pin 3.5 mm detachable terminal block;
24VDC power input;
Power pack sold separately, required only if the wall plate receiver is used with a wall plate transmitter

Specifications

For product specifications, visit the product pages on the Crestron website. The product pages are listed below based on device type (transmitter or receiver) and form factor (surface-mountable or wall plate).

Transmitters, Surface-Mountable:

- [HD-TX-4KZ-101](#)
- [HD-TXA-4KZ-101](#)
- [HD-TXC-4KZ-101](#)
- [HD-TXCA-4KZ-101](#)
- [HD-TX-4KZ-111](#)
- [HD-TX-4KZ-201](#)
- [HD-TX-4KZ-211-CHGR](#)
- [HD-TX-4KZ-401](#)
- [HD-TX-4KZ-421-CHGR](#)
- [HD-TXU-4KZ-111-E](#)
- [HD-TXU-4KZ-211](#)
- [HD-TXU-4KZ-211-CHGR](#)

Transmitters, Wall Plate:

- [HD-TX-4KZ-101-1G-B](#)
- [HD-TX-4KZ-101-1G-W](#)
- [HD-TX-4KZ-111-1G-B](#)
- [HD-TX-4KZ-111-1G-W](#)
- [HD-TXA-4KZ-101-1G-B](#)
- [HD-TXC-4KZ-101-1G-B](#)
- [HD-TXC-4KZ-101-1G-W](#)
- [HD-TX-4KZ-211-2G-B](#)
- [HD-TX-4KZ-211-2G-W](#)
- [HD-TXU-4KZ-111-2G-B](#)
- [HD-TXU-4KZ-111-2G-W](#)

Receivers, Surface-Mountable:

- [HD-RX-4KZ-101](#)
- [HD-RXA-4KZ-101](#)
- [HD-RXC-4KZ-101](#)
- [HD-RXCA-4KZ-101](#)

- [HD-RXU-4KZ-101-E](#)
- [HD-RXU-4KZ-202](#)

Receivers, Wall Plate:

- [HD-RX-4KZ-101-1G-B](#)
- [HD-RXC-4KZ-101-1G-B](#)
- [HD-RXU-4KZ-101-2G-B](#)

Installation

This section provides the following information related to the installation of DM Essentials transmitters and receivers:

- [Installation guidelines](#)
- [Surface-mountable device installation](#)
- [Wall plate device installation](#)

Installation Guidelines

Before installing the device, be aware of the following information regarding [DM Essentials cabling](#), [HDMI cabling](#), and the [power connection](#) to the device.

DM Essentials Cabling

The DM Essentials output port of a DM Essentials 4K60 4:4:4 transmitter must be connected to a DM Essentials input port of a DM Essentials receiver or DMPS Essentials switcher. Similarly, the DM Essentials input port of a DM Essentials 4K60 4:4:4 receiver must be connected to a DM Essentials output port of a DM Essentials transmitter or DMPS Essentials switcher. For DM Essentials connections, use Crestron DM-CBL-8G, Crestron DM-CBL-ULTRA, or third-party CAT5e or higher cable. (Crestron DM-CBL Series cables are sold separately.)

NOTE: Cables that can be used for DM Essentials connections are designed for intrabuilding use only.

To safeguard against unpredictable environmental electrical noise that may impact performance at resolutions above 1080p, shielded cable and connectors are recommended for all applications and are required when bundling multiple cables in a wire run.

The following table provides information about the maximum transmission distance for each cable type.

Maximum DM Essentials Transmission Distance

Resolution	Frame Rate (Hz)	Color Sampling	Color Depth	Cable Type	
				DM-CBL-ULTRA Cable	DM-CBL-8G Cable or CAT5e (UTP) or Higher
1920x1080 HD 1080i*	30	4:4:4	12 bit		
1920x1080 FHD 1080p	60	4:4:4	8, 12 bit		
1600x1200 UXGA	60	4:4:4	8, 12 bit		
2048x1080 DCI 2K	60	4:4:4	8, 12 bit		
1920x1200 WUXGA	60	4:4:4	8, 12 bit		
2048x1152 QWXGA	60	4:4:4	8, 12 bit		
2560x1080 UWFHD	60	4:4:4	8 bit	230 ft (70 m)	195 ft (60 m)
2560x1440 WQHD Reduced Blanking	60	4:4:4	8 bit		
2560x1600 WQXGA Reduced Blanking	60	4:4:4	8 bit		
2048x1152 QWXGA	60	4:4:4	12 bit		
3840x2160 4K UHD and 4096x2160 DCI 4K	30	4:2:2	12 bit		
	30	4:4:4	8 bit		
	60	4:2:0	8 bit		
3840x2160 4K UHD and 4096x2160 DCI 4K	30	4:4:4	12 bit	130 ft (40 m)	100 ft (30 m)
	60	4:2:0	12 bit		
	60	4:2:2	12 bit		
	60	4:4:4	8 bit		

*Interlaced video is applicable to HDMI inputs only.

HDMI Cabling

4K60 4:4:4 performance and HDR support require the use of HDMI cables and couplers with a minimum TMDS bandwidth of 18 Gbps. If 4K60 4:2:0 or 4K30 4:4:4 performance is acceptable, cables and couplers with a minimum bandwidth of 10.2 Gbps can be used. Bandwidth loss is cumulative; therefore, performance may be reduced when inserting multiple cables and couplers inline.

An HDMI input requires an appropriate adapter or interface cable to accommodate a Dual-Mode DisplayPort™ or DVI signal. An HDMI output requires an appropriate adapter or interface cable to accommodate a DVI signal. Crestron CBL-HD-DVI interface cables are sold separately.

Power Connection

Be aware of the following guidelines regarding the power connection for a [surface-mountable transmitter](#), [surface-mountable receiver](#), [wall plate transmitter](#), and [wall plate receiver](#).

Surface-Mountable Transmitter Power Connection

A 24VDC power pack is included with a surface-mountable DM Essentials transmitter. Be aware of the following:

- When a surface-mountable DM Essentials transmitter other than an HD-TXU-4KZ-211(-CHGR) is paired with a surface-mountable DM Essentials receiver, either the power pack included with the transmitter or the receiver can be used to power both devices. Power is transmitted over the CATx cable that connects the surface-mountable transmitter to the surface-mountable receiver. A power pack must not be connected to both devices simultaneously.

An HD-TXU-4KZ-211(-CHGR), which is designed for use with an HD-RXU-4KZ Series receiver, must always be powered by the included power pack and cannot receive power from a DM Essentials receiver. However, the HD-TXU-4KZ-211(-CHGR) can provide power to a DM Essentials receiver.

- When a surface-mountable DM Essentials transmitter is paired with a wall plate DM Essentials receiver, the power pack included with the transmitter is used to power both devices. Power is transmitted over the CATx cable that connects the surface-mountable transmitter to the wall plate receiver.
- When a surface-mountable DM Essentials transmitter other than an HD-TXU-4KZ-211(-CHGR) is paired with a DMPS Essentials switcher, the switcher provides power to the transmitter. Power is transmitted over the CATx cable that connects the surface-mountable transmitter to the switcher. The transmitter must not be connected to the included power pack.

Surface-Mountable Receiver Power Connection

A 24VDC power pack is included with a surface-mountable DM Essentials receiver. Be aware of the following:

- When a surface-mountable DM Essentials receiver other than an HD-RXU-4KZ-202 is paired with a surface-mountable DM Essentials transmitter, either the power pack included with the receiver or the transmitter can be used to power both devices. Power is transmitted over the CATx cable that connects the surface-mountable receiver to the surface-mountable transmitter. A power pack must not be connected to both devices simultaneously.

An HD-RXU-4KZ-202, which is designed for use with an HD-TXU-4KZ Series transmitter, must always be powered by the included power pack and cannot receive power from a DM Essentials transmitter. However, the HD-RXU-4KZ-202 can provide power to a DM Essentials transmitter.

- When a surface-mountable DM Essentials receiver is paired with a wall plate DM Essentials transmitter, the power pack included with the receiver is used to power both devices. Power is transmitted over the CATx cable that connects the surface-mountable receiver to the wall plate transmitter.
- When a surface-mountable DM Essentials receiver other than an HD-RXU-4KZ-202 is paired with a DMPS Essentials switcher, the switcher provides power to the receiver. Power is transmitted over the CATx cable that connects the surface-mountable receiver to the switcher. The receiver must not be connected to the included power pack.

Wall Plate Transmitter Power Connection

No power pack is included with a wall plate DM Essentials transmitter. Be aware of the following:

- When a wall plate DM Essentials transmitter is paired with a surface-mountable DM Essentials receiver, the power pack included with the receiver is used to power both devices. Power is transmitted over the CATx cable that connects the wall plate transmitter to the surface-mountable receiver.
- When a wall plate DM Essentials transmitter is paired with a DMPS Essentials switcher, the switcher provides power to the transmitter. Power is transmitted over the CATx cable that connects the wall plate transmitter to the switcher.
- If a wall plate DM Essentials transmitter is paired with a wall plate DM Essentials receiver, the devices must be powered independently by a PW-2407WUL power pack (sold separately) for each device. A wall plate transmitter and wall plate receiver cannot provide power over the CATx cable to the remote device with which it is paired.

Wall Plate Receiver Power Connection

No power pack is included with a wall plate DM Essentials receiver. Be aware of the following:

- When a wall plate DM Essentials receiver is paired with a surface-mountable DM Essentials transmitter, the power pack included with the transmitter is used to power both devices. Power is transmitted over the CATx cable that connects the wall plate receiver to the surface-mountable transmitter.
- When a wall plate DM Essentials receiver is paired with a DMPS Essentials switcher, the switcher provides power to the receiver. Power is transmitted over the CATx cable that connects the wall plate receiver to the switcher.
- If a wall plate DM Essentials receiver is paired with a wall plate DM Essentials transmitter, the devices must be powered independently by a PW-2407WUL power pack (sold separately) for each device. A wall plate receiver and wall plate transmitter cannot provide power over the CATx cable to the remote device with which it is paired.

Surface-Mountable Device Installation

This section provides information about installing and making connections to surface-mountable DM Essentials transmitters and receivers.

In the Box

Qty.	Description
1	DM Essentials transmitter or receiver, surface mountable
Additional Items	
HD-TX-4KZ-101, HD-TX-4KZ-111, HD-RX-4KZ-101, HD-TX-4KZ-201, HD-TX-4KZ-401 , HD-TXU-4KZ-211, and HD-RXU-4KZ-202 Only	
2	Bracket, Mounting (2057072)
4	Screw, 4-40 x 1/4 in. Pan Head, Phillips (2007158)
4	Screw, 6-32 x 3/4 in. Truss Head, Combo (2009211)
4	Washer, Flat, Steel, Zinc, #6, Type B Regular (2007664)
4	Anchor, Wall, #6 x 1-5/16 in. (2043585)
1	Power Pack, 24VDC, 2.5A, 100-240VAC (2045873)
1	Power Cord, 5 ft 10 in. (1.78 m) (2042043)
HD-TXA-4KZ-101 and HD-RXA-4KZ-101 Only	
2	Bracket, Mounting (2057072)
4	Screw, 4-40 x 1/4 in. Pan Head, Phillips (2007158)
4	Screw, 6-32 x 3/4 in. Truss Head, Combo (2009211)
4	Washer, Flat, Steel, Zinc, #6, Type B Regular (2007664)
4	Anchor, Wall, #6 x 1-5/16 in. (2043585)
1	Power Pack, 24VDC, 2.5A, 100-240VAC (2045873)
1	Power Cord, 5 ft 10 in. (1.78 m) (2042043)
1	Connector, 5-Pin (2003577)
HD-TXC-4KZ-101 and HD-RXC-4KZ-101 Only	
2	Bracket, Mounting (2057072)
4	Screw, 4-40 x 1/4 in. Pan Head, Phillips (2007158)
4	Screw, 6-32 x 3/4 in. Truss Head, Combo (2009211)

Qty.	Description
4	Washer, Flat, Steel, Zinc, #6, Type B Regular (2007664)
4	Anchor, Wall, #6 x 1-5/16 in. (2043585)
1	Power Pack, 24VDC, 2.5A, 100-240VAC (2045873)
1	Power Cord, 5 ft 10 in. (1.78 m) (2042043)
1	Connector, 3-Pin (2003575)
1	Connector, 4-Pin (2003576)
HD-TXCA-4KZ-101 and HD-RXCA-4KZ-101 Only	
2	Bracket, Mounting (2057072)
4	Screw, 4-40 x 1/4 in. Pan Head, Phillips (2007158)
4	Screw, 6-32 x 3/4 in. Truss Head, Combo (2009211)
4	Washer, Flat, Steel, Zinc, #6, Type B Regular (2007664)
4	Anchor, Wall, #6 x 1-5/16 in. (2043585)
1	Power Pack, 24VDC, 2.5A, 100-240VAC (2045873)
1	Power Cord, 5 ft 10 in. (1.78 m) (2042043)
1	Connector, 3-Pin (2003575)
1	Connector, 4-Pin (2003576)
1	Connector, 5-Pin (2003577)
HD-TX-4KZ-211-CHGR, HD-TX-4KZ-421-CHGR, and HD-TXU-4KZ-211-CHGR Only	
2	Bracket, Mounting (2057072)
4	Screw, 4-40 x 1/4 in. Pan Head, Phillips (2007158)
4	Screw, 6-32 x 3/4 in. Truss Head, Combo (2009211)
4	Washer, Flat, Steel, Zinc, #6, Type B Regular (2007664)
4	Anchor, Wall, #6 x 1-5/16 in. (2043585)
1	Power Pack, 24VDC, 7.5A, 100-240VAC (2058647)
1	Power Cord, 6 ft 7 in. (2 m) (2001134)
HD-TXU-4KZ-111-E and HD-RXU-4KZ-101-E Only	
2	Bracket, Mounting (2057347)
4	Screw, 4-40 x 1/4 in. Pan Head, Phillips (2007158)
4	Screw, 6-32 x 3/4 in. Truss Head, Combo (2009211)

Qty.	Description
4	Washer, Flat, Steel, Zinc, #6, Type B Regular (2007664)
4	Anchor, Wall, #6 x 1-5/16 in. (2043585)
1	Power Pack, 24VDC, 2.5A, 100-240VAC (2045873)
1	Power Cord, 5 ft 10 in. (1.78 m) (2042043)

Installing a Surface-Mountable Device

A DM Essentials surface-mountable device can be mounted onto a flat surface such as a wall or the underside of a table. The device can also be mounted onto a single rack rail.

Mounting onto a Wall

To mount a surface-mountable device onto a wall:

- Using the four included 4-40 x 1/4 in. Phillips pan head screws, attach the two included brackets to the left and right side panels of the device. Side panels vary depending on the physical design of the DM Essentials model. Examples of bracket installation for wall mounting are provided in the following illustrations.

Bracket Attachment for HD-TX(A)(C)(CA)-4KZ-1x1 and HD-RX(A)(C)(CA)-4KZ-101 Series Wall Mounting (HD-TXCA-4KZ-101 Shown)

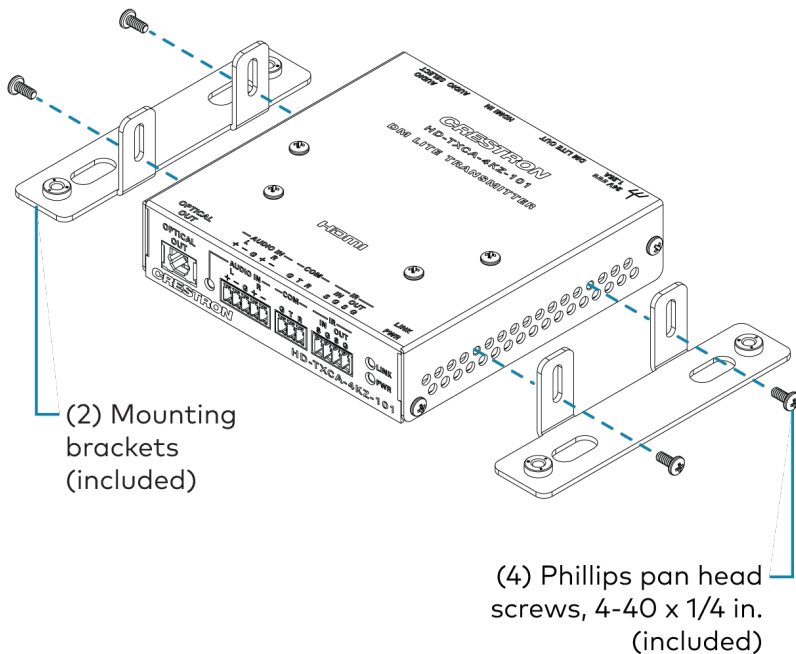

Bracket Attachment for HD-TX-4KZ-201/401/211-CHGR/421-CHGR Wall Mounting (HD-TX-4KZ-421-CHGR Shown)

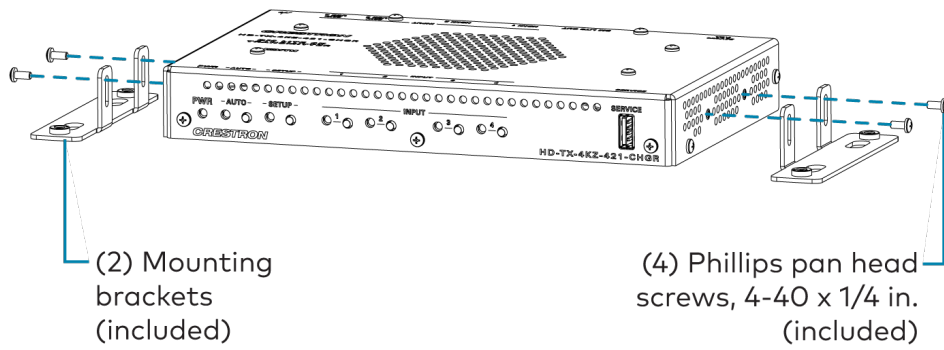

Bracket Attachment for HD-TXU-4KZ-111-E and HD-RXU-4KZ-101-E Wall Mounting (HD-TXU-4KZ-111-E Shown)

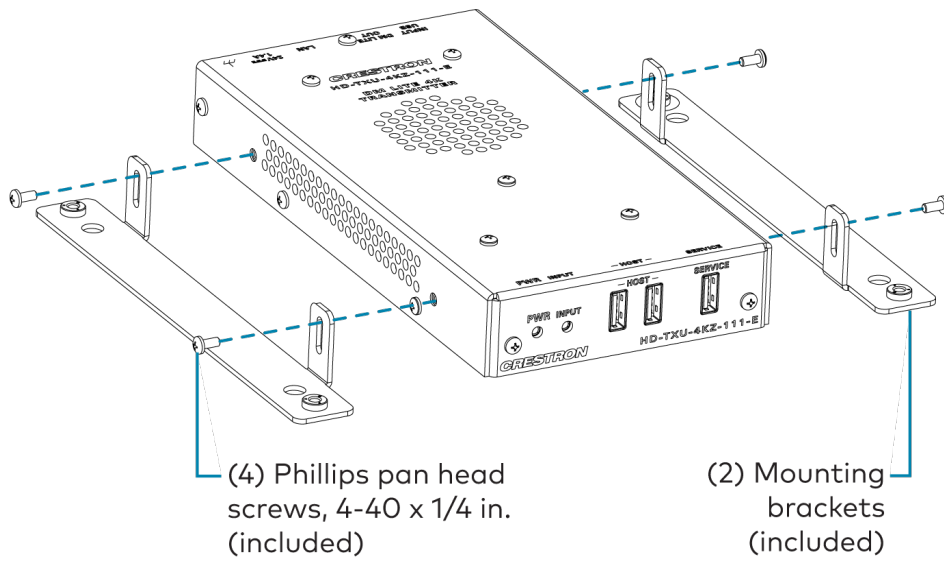

Bracket Attachment for HD-TXU-4KZ-211 and HD-TXU-4KZ-211-CHGR Wall Mounting (HD-TXU-4KZ-211-CHGR Shown)

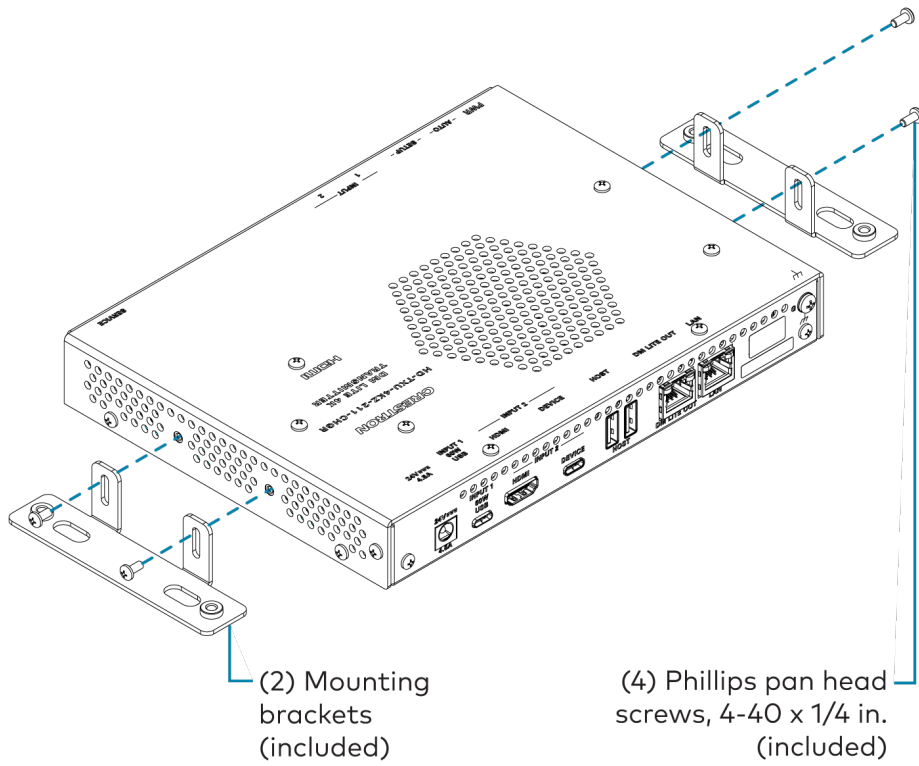

Bracket Attachment for HD-RXU-4KZ-202 Wall Mounting

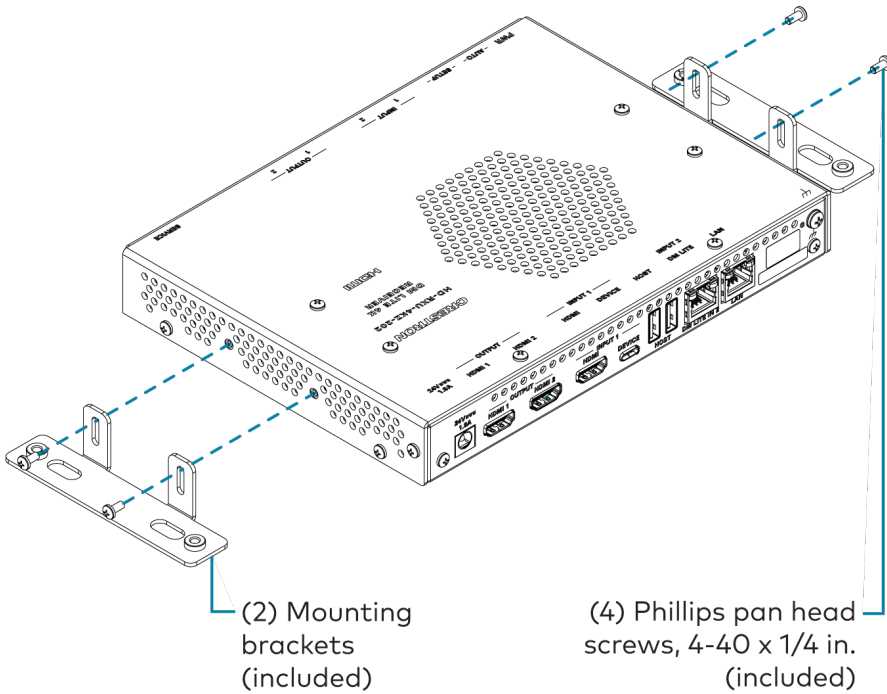

- Using the four included anchors, washers, and 6-32 x 3/4 in. combo truss head screws, attach the device to the wall. For example purposes, the HD-TXCA-4KZ-101 is shown in the following illustration.

Wall Mounting (HD-TXCA-4KZ-101 Shown)

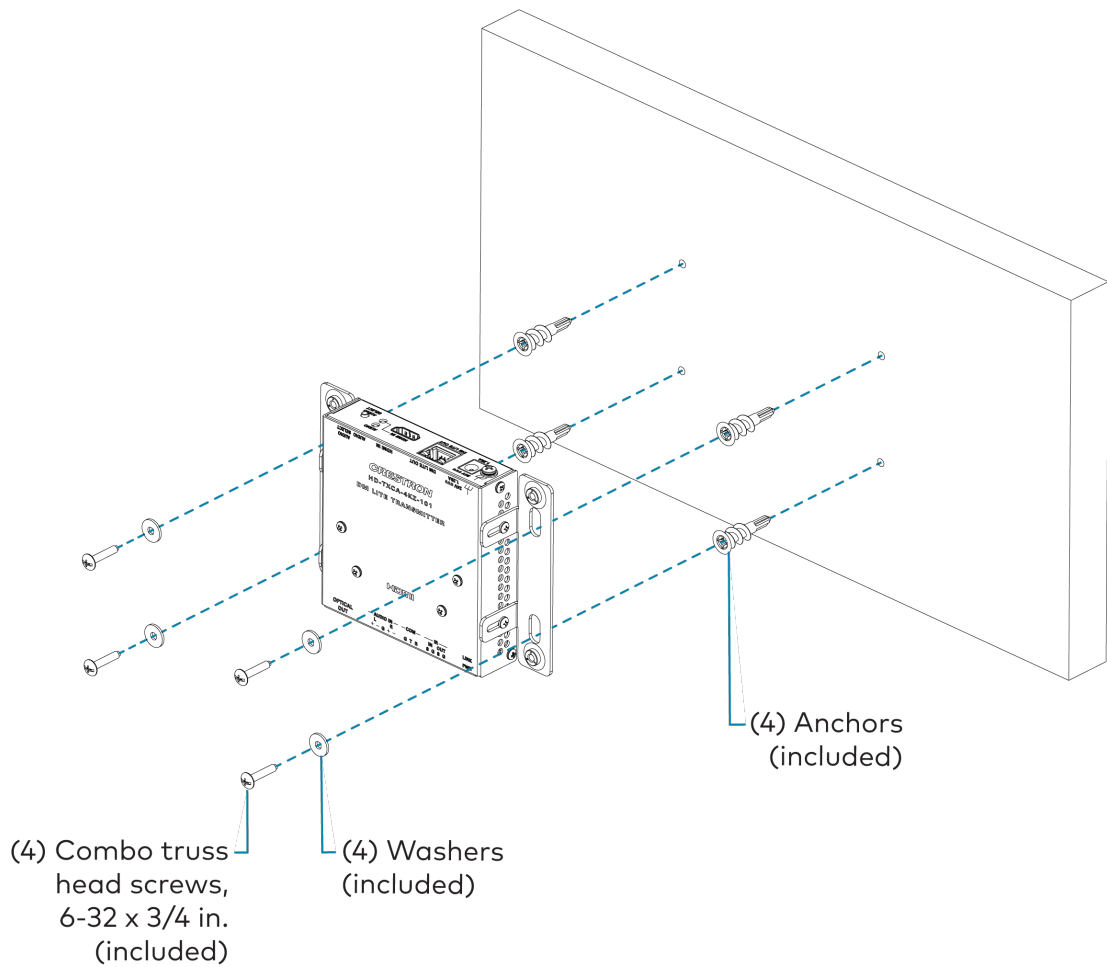

Mounting to the Underside of a Table

To mount a surface-mountable device to the underside of a table:

1. Using the four included 4-40 x 1/4 in. Phillips pan head screws, attach the two included brackets to the left and right side panels of the device. Side panels vary depending on the physical design of the DM Essentials model. Examples of bracket installation for under table mounting are provided in the following illustrations.

NOTE: To ensure proper ventilation of the surface-mountable device, install the brackets at the bottom end of the bracket slots as illustrated. Doing so provides adequate space between the bottom of the table and the top of the device.

Bracket Attachment for HD-TX(A)(C)(CA)-4KZ-1x1 and HD-RX(A)(C)(CA)-4KZ-101 Series Under Table Mounting (HD-TXCA-4KZ-101 Shown)

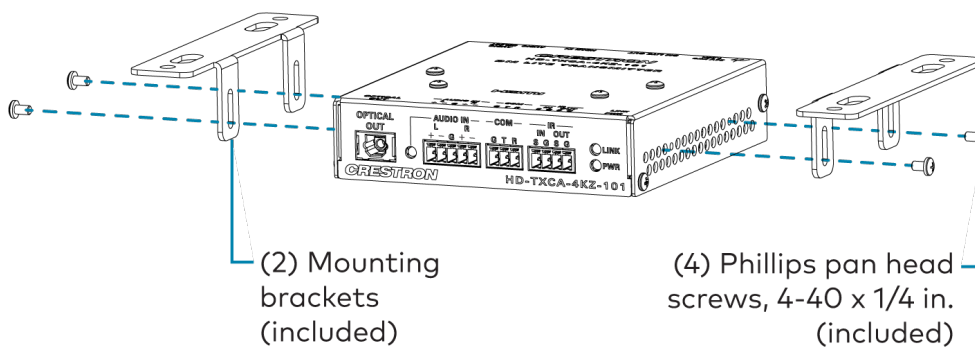

Bracket Attachment for HD-TX-4KZ-201/401/211-CHGR/421-CHGR Under Table Mounting (HD-TX-4KZ-421-CHGR Shown)

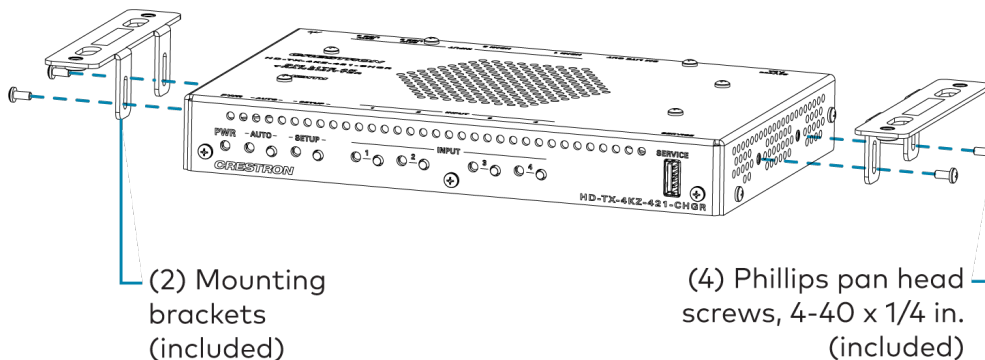

Bracket Attachment for HD-TXU-4KZ-111-E and HD-RXU-4KZ-101-E Under Table Mounting (HD-TXU-4KZ-111-E Shown)

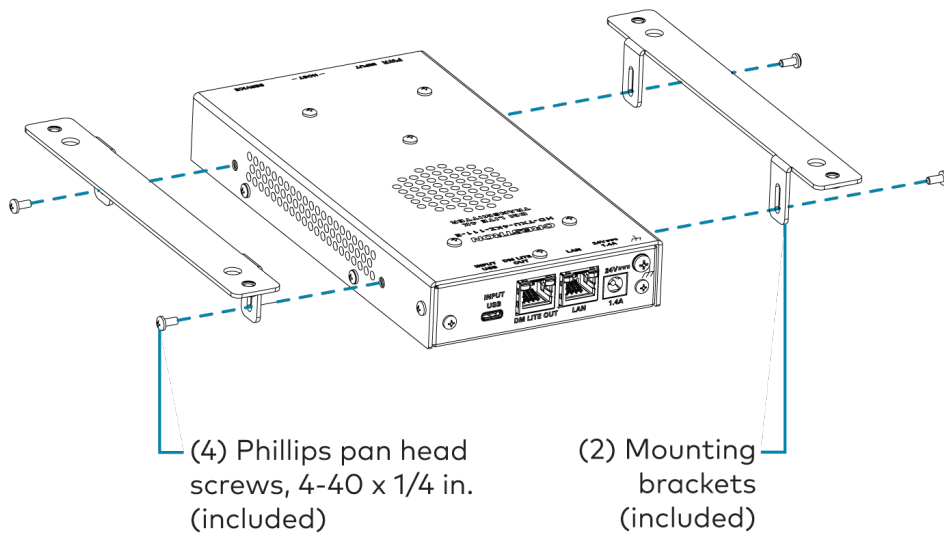

Bracket Attachment for HD-TXU-4KZ-211 and HD-TXU-4KZ-211-CHGR Under Table Mounting (HD-TXU-4KZ-211-CHGR Shown)

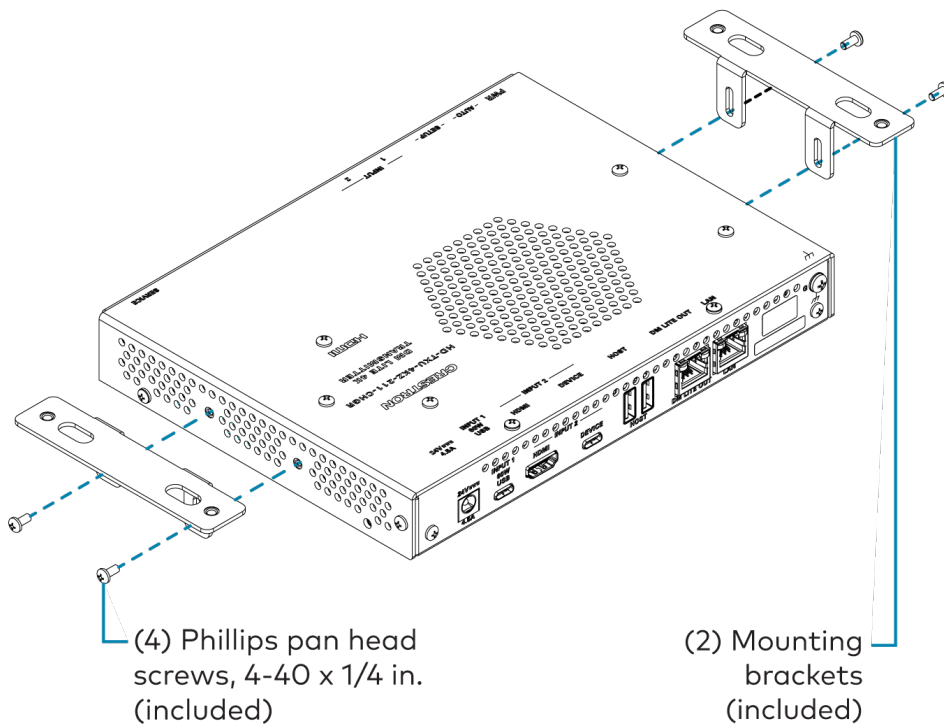

Bracket Attachment for HD-RXU-4KZ-202 Under Table Mounting

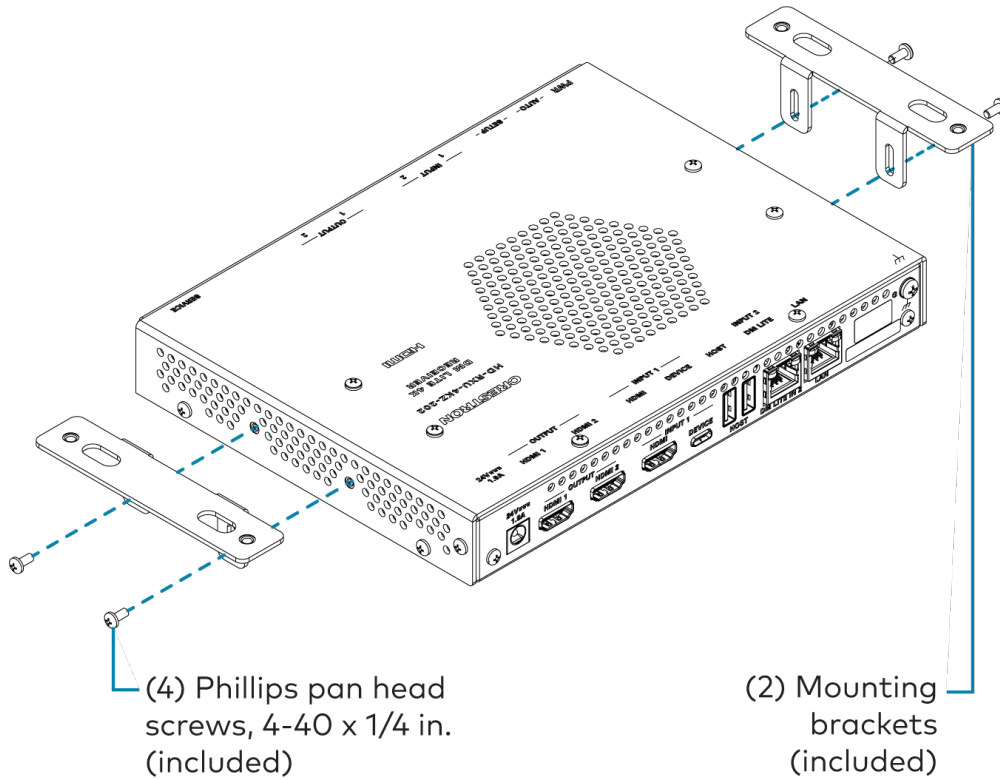

- Using four screws (not included), attach the device to the underside of a table. For example purposes, the HD-TXCA-4KZ-101 is shown in the following illustration.

Under Table Mounting (HD-TXCA-4KZ-101 Shown)

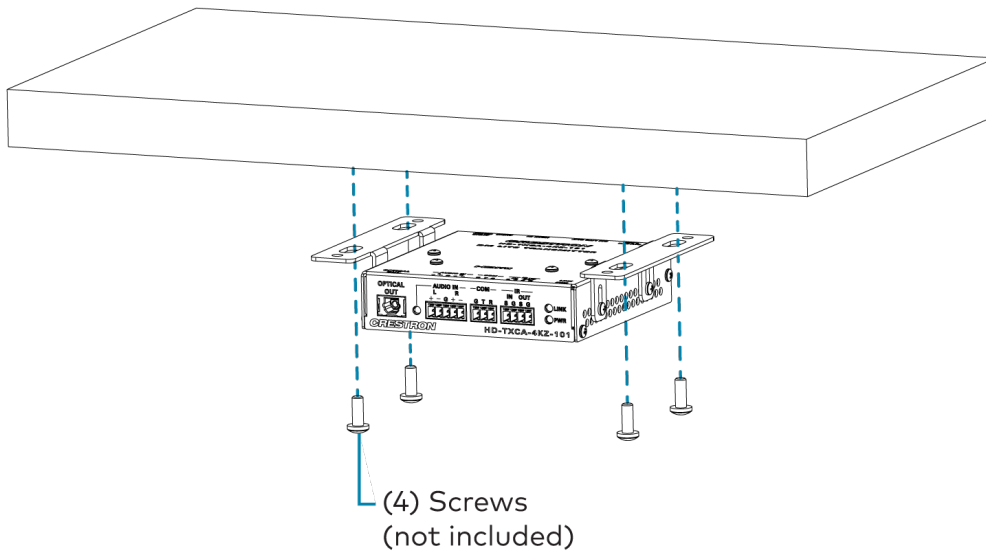

Mounting onto a Rack Rail

To mount a surface-mountable device onto a single rack rail:

1. Position one of the mounting brackets so that the holes align with the holes in the rack rail.
2. Secure the device to the rack rail using two rack mount screws (not included).

For example purposes, mounting of the HD-TXCA-4KZ-101 onto a rack rail is shown in the following illustration.

Rack Rail Mounting (HD-TXCA-4KZ-101 Shown)

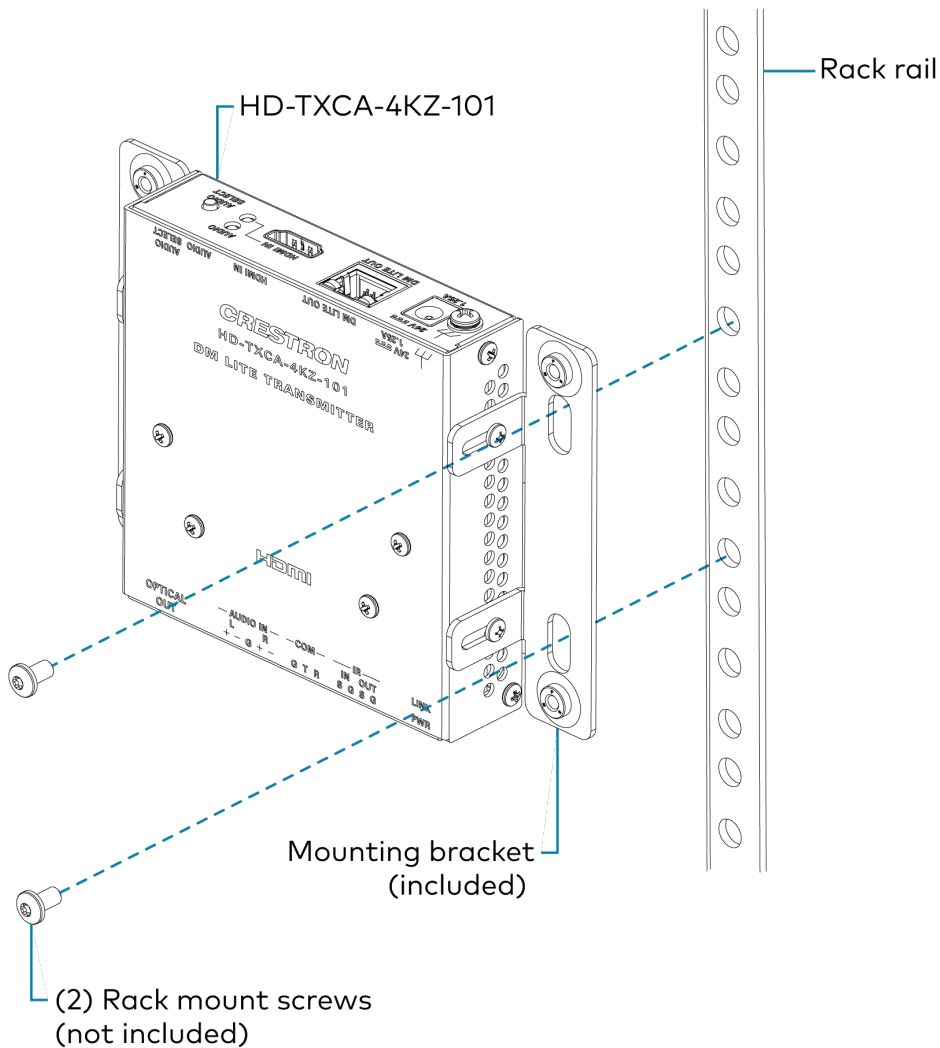

Connecting a Surface-Mountable Device

This section provides information about the following:

- [Surface-mountable transmitter connections](#)
- [Surface-mountable receiver connections](#)

Surface-Mountable Transmitter Connections

This section provides information about making connections to the following surface-mountable transmitters:

- [HD-TX-4KZ-101](#)
- [HD-TXA-4KZ-101](#)
- [HD-TXC-4KZ-101](#)
- [HD-TXCA-4KZ-101](#)
- [HD-TX-4KZ-111](#)
- [HD-TX-4KZ-201](#)
- [HD-TX-4KZ-211-CHGR](#)
- [HD-TX-4KZ-401](#)
- [HD-TX-4KZ-421-CHGR](#)
- [HD-TXU-4KZ-111-E](#)
- [HD-TXU-4KZ-111-E](#)
- [HD-TXU-4KZ-211](#)
- [HD-TXU-4KZ-211-CHGR](#)

HD-TX-4KZ-101 Connections

Refer to the following illustration for general information about HD-TX-4KZ-101 rear panel connections.

NOTE: For guidelines regarding DM Essentials cabling, HDMI cabling, and the surface-mountable transmitter power connection, refer to [Installation Guidelines](#).

HD-TX-4KZ-101 Rear Panel Connections

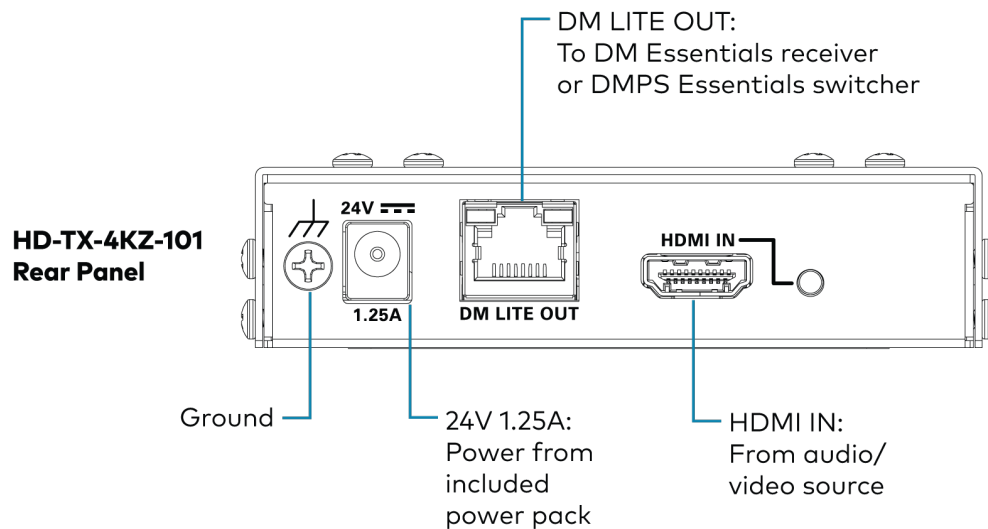

HD-TXA-4KZ-101 Connections

Refer to the following illustration for general information about HD-TXA-4KZ-101 front and rear panel connections.

NOTE: For guidelines regarding DM Essentials cabling, HDMI cabling, and the surface-mountable transmitter power connection, refer to [Installation Guidelines](#).

HD-TXA-4KZ-101 Front and Rear Panel Connections

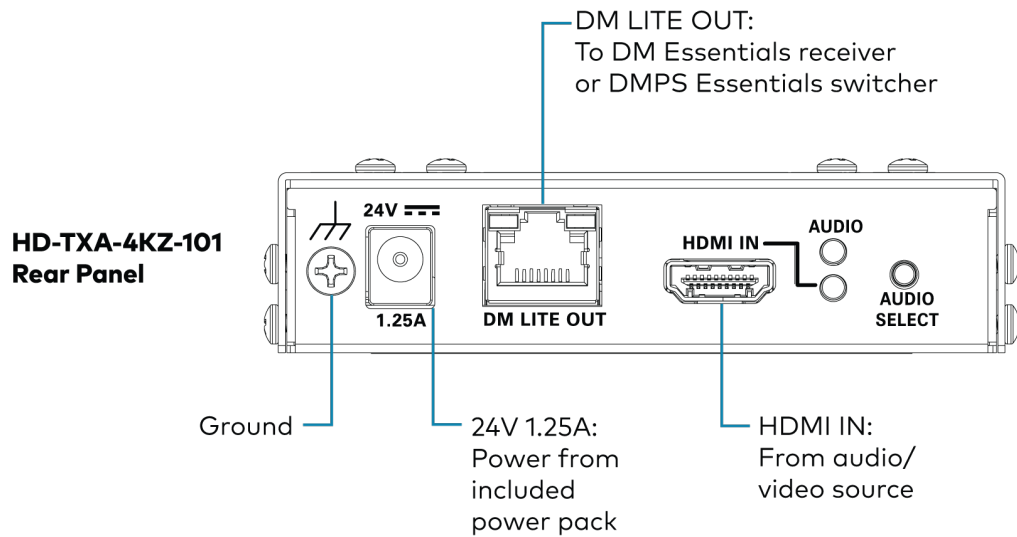
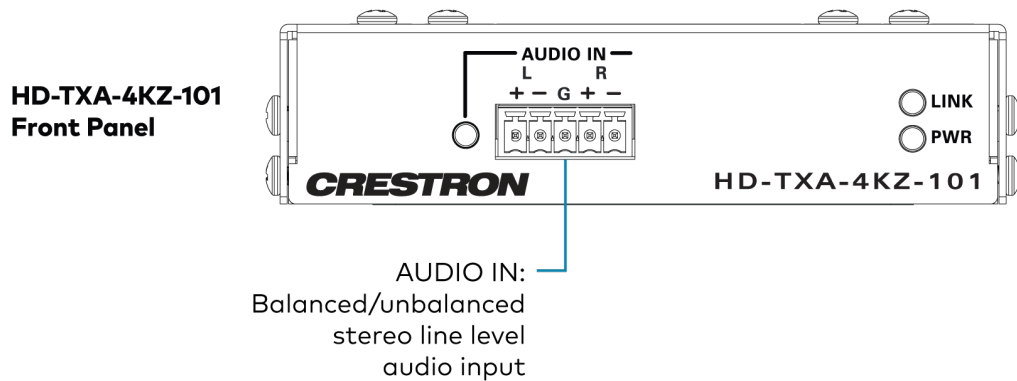

The front panel of the device includes a 5-pin terminal block connector for balanced or unbalanced analog audio input. Refer to the following table and diagram for pin assignments and connection information.

Analog Audio Input Pin Assignments

Signal Name	Balanced Audio Input	Unbalanced Audio Input
+	L+	L+ In
-	L-	L- Signal return, jumper to GND
G	Shield/ground	Ground
+	R+	R+ In
-	R-	R- Signal return, jumper to GND

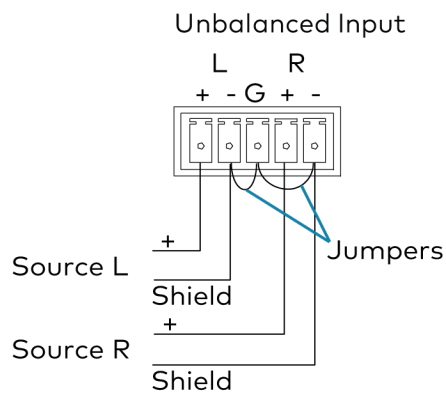
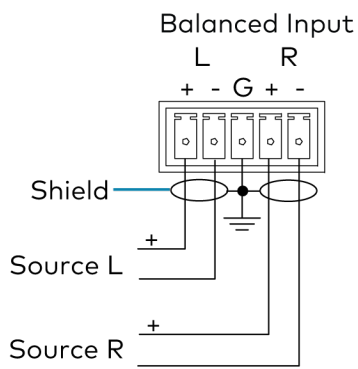

HD-TXC-4KZ-101 Connections

Refer to the following illustration for general information about HD-TXC-4KZ-101 front and rear panel connections.

NOTE: For guidelines regarding DM Essentials cabling, HDMI cabling, and the surface-mountable transmitter power connection, refer to [Installation Guidelines](#).

HD-TXC-4KZ-101 Front and Rear Panel Connections

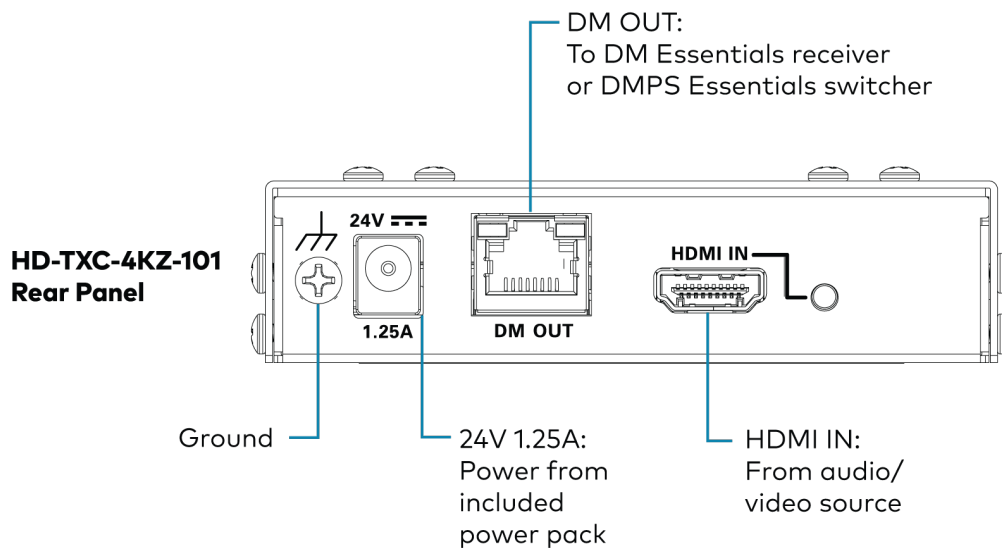
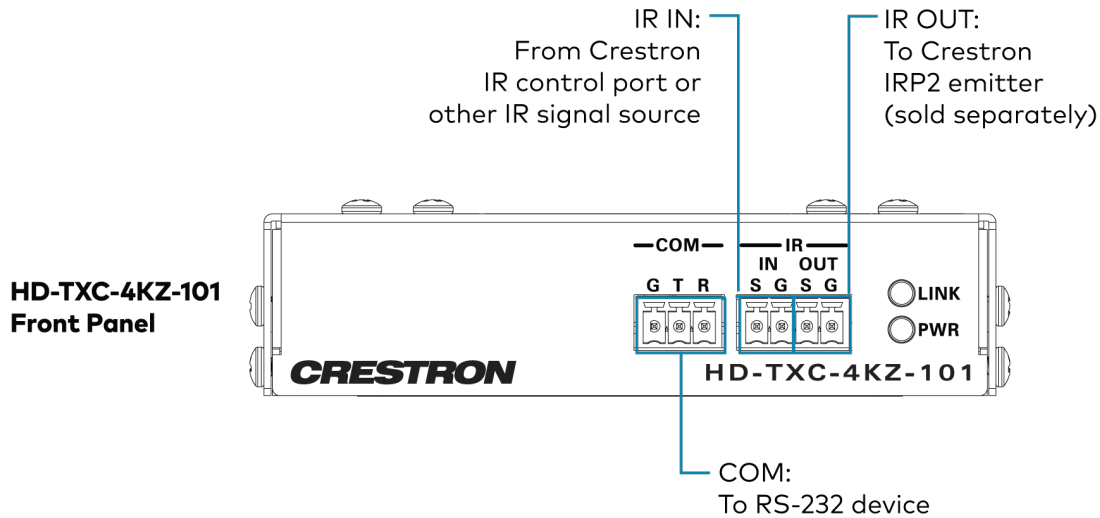

HD-TXCA-4KZ-101 Connections

Refer to the following illustration for general information about HD-TXCA-4KZ-101 front and rear panel connections.

NOTE: For guidelines regarding DM Essentials cabling, HDMI cabling, and the surface-mountable transmitter power connection, refer to [Installation Guidelines](#).

HD-TXCA-4KZ-101 Front and Rear Panel Connections

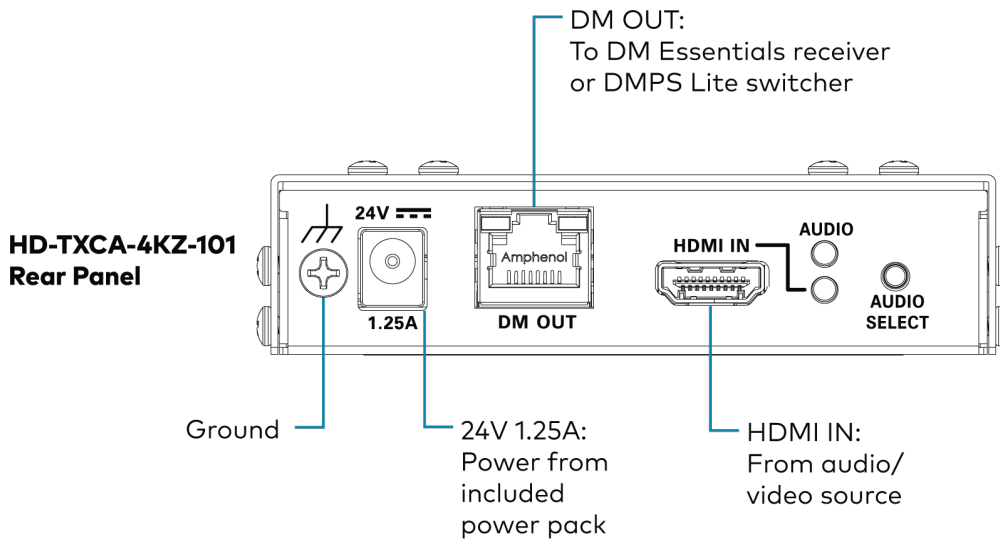
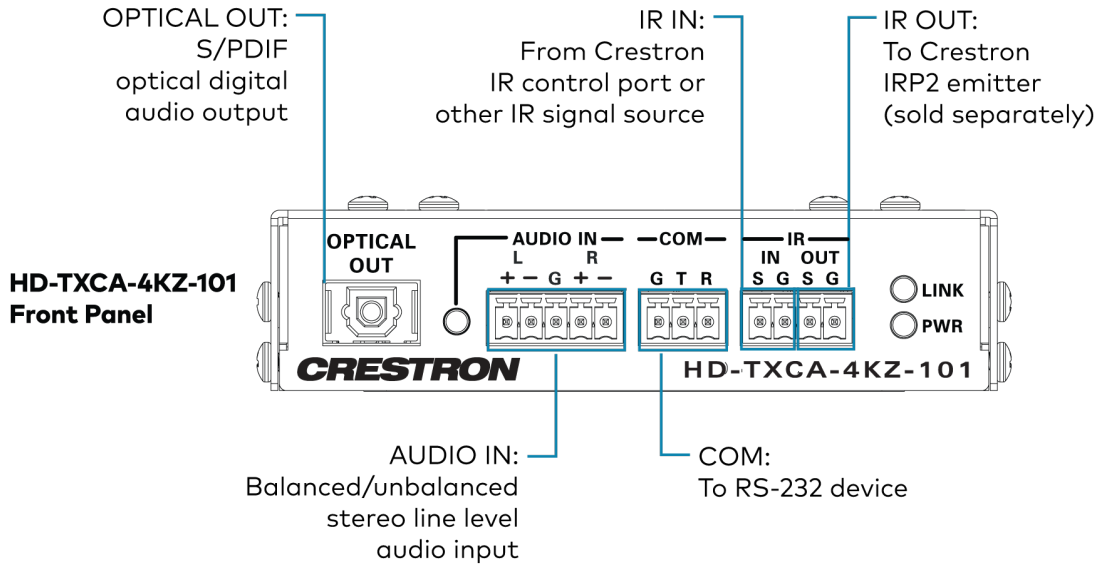

The front panel of the device includes a 5-pin terminal block connector for balanced or unbalanced analog audio input. Refer to the following table and diagram for pin assignments and connection information.

Analog Audio Input Pin Assignments

Signal Name	Balanced Audio Input	Unbalanced Audio Input
+	L+	L+ In
-	L-	L- Signal return, jumper to GND
G	Shield/ground	Ground
+	R+	R+ In
-	R-	R- Signal return, jumper to GND

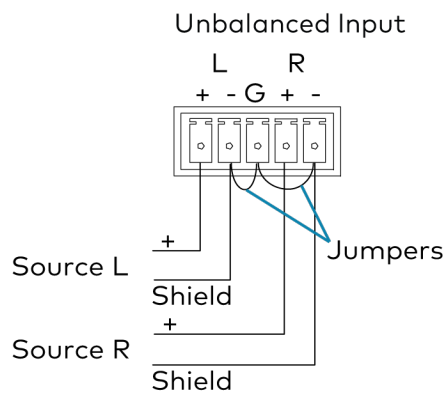
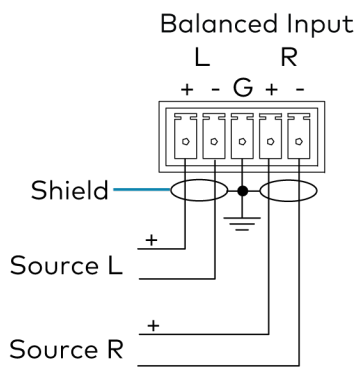

HD-TX-4KZ-111 Connections

Refer to the following illustration for general information about HD-TX-4KZ-111 rear panel connections.

NOTE: For guidelines regarding DM Essentials cabling and the surface-mountable transmitter power connection, refer to [Installation Guidelines](#).

HD-TX-4KZ-111 Rear Panel Connections

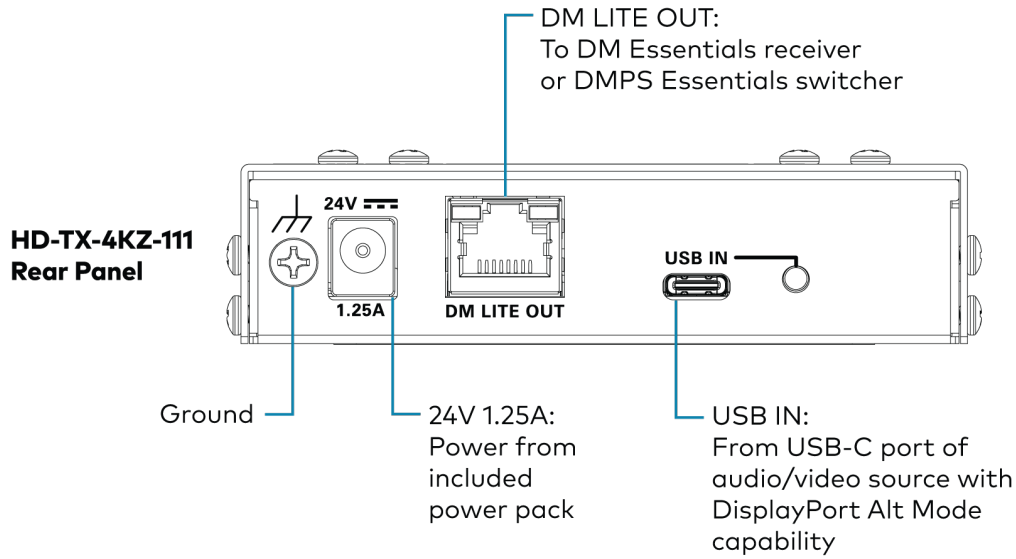

HD-TX-4KZ-201 Connections

Refer to the following illustration for general information about HD-TX-4KZ-201 front and rear panel connections.

NOTE: For guidelines regarding DM Essentials cabling, HDMI cabling, and the surface-mountable transmitter power connection, refer to [Installation Guidelines](#).

HD-TX-4KZ-201 Front and Rear Panel Connections

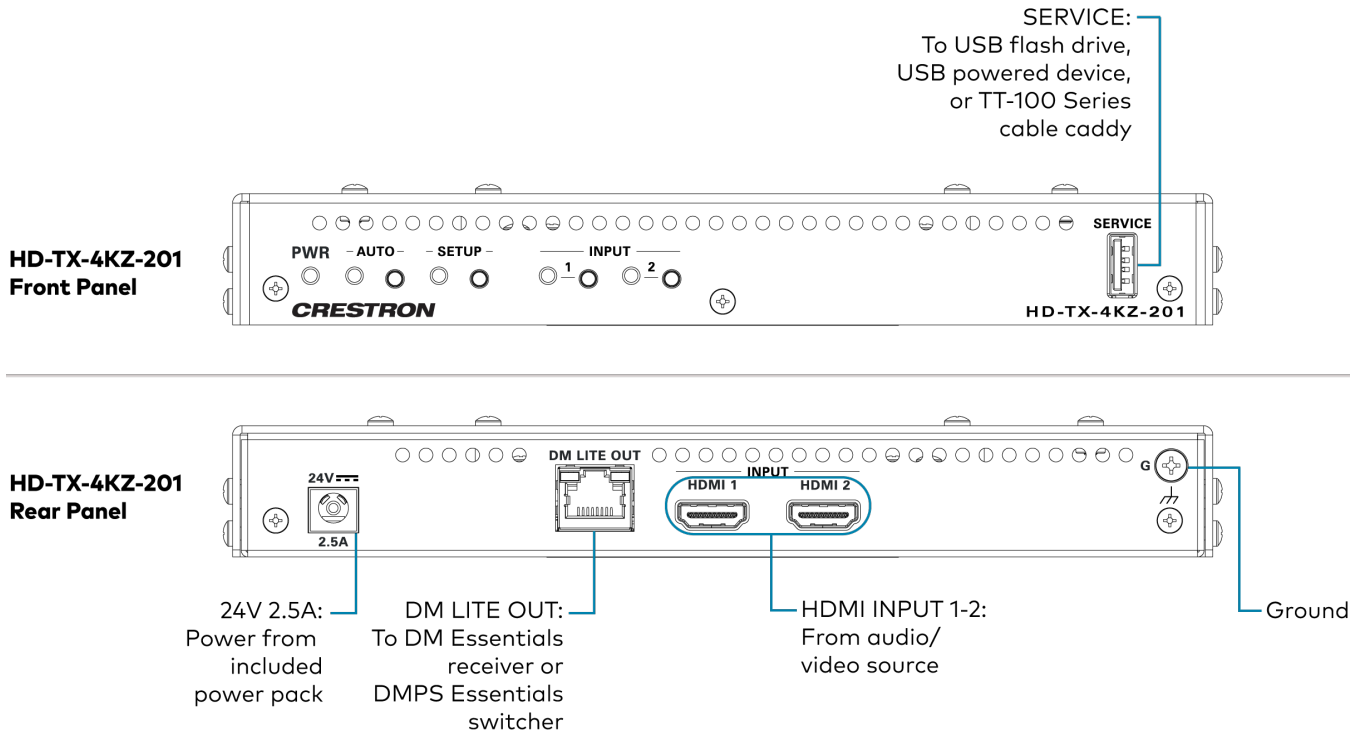

HD-TX-4KZ-211-CHGR Connections

Refer to the following illustration for general information about HD-TX-4KZ-211-CHGR front and rear panel connections.

NOTE: For guidelines regarding DM Essentials cabling, HDMI cabling, and the surface-mountable transmitter power connection, refer to [Installation Guidelines](#).

HD-TX-4KZ-211-CHGR Front and Rear Panel Connections

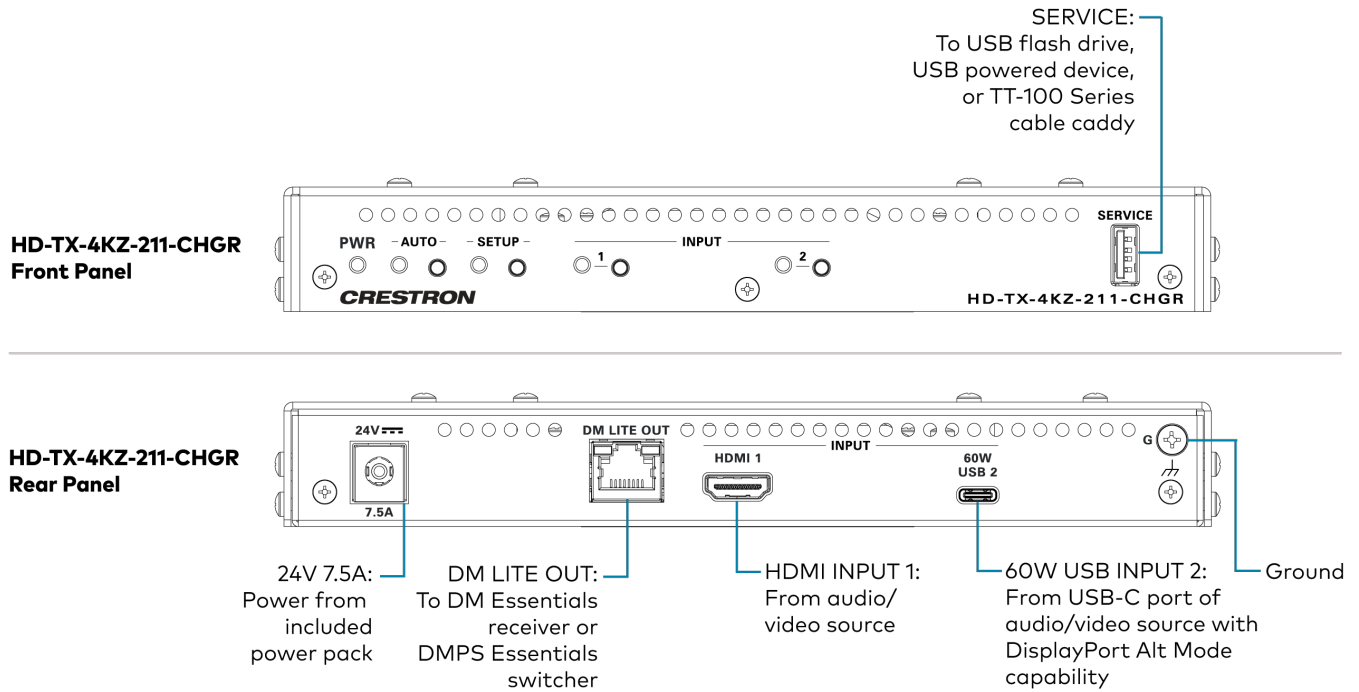

HD-TX-4KZ-401 Connections

Refer to the following illustration for general information about HD-TX-4KZ-401 front and rear panel connections.

NOTE: For guidelines regarding DM Essentials cabling, HDMI cabling, and the surface-mountable transmitter power connection, refer to [Installation Guidelines](#).

HD-TX-4KZ-401 Front and Rear Panel Connections

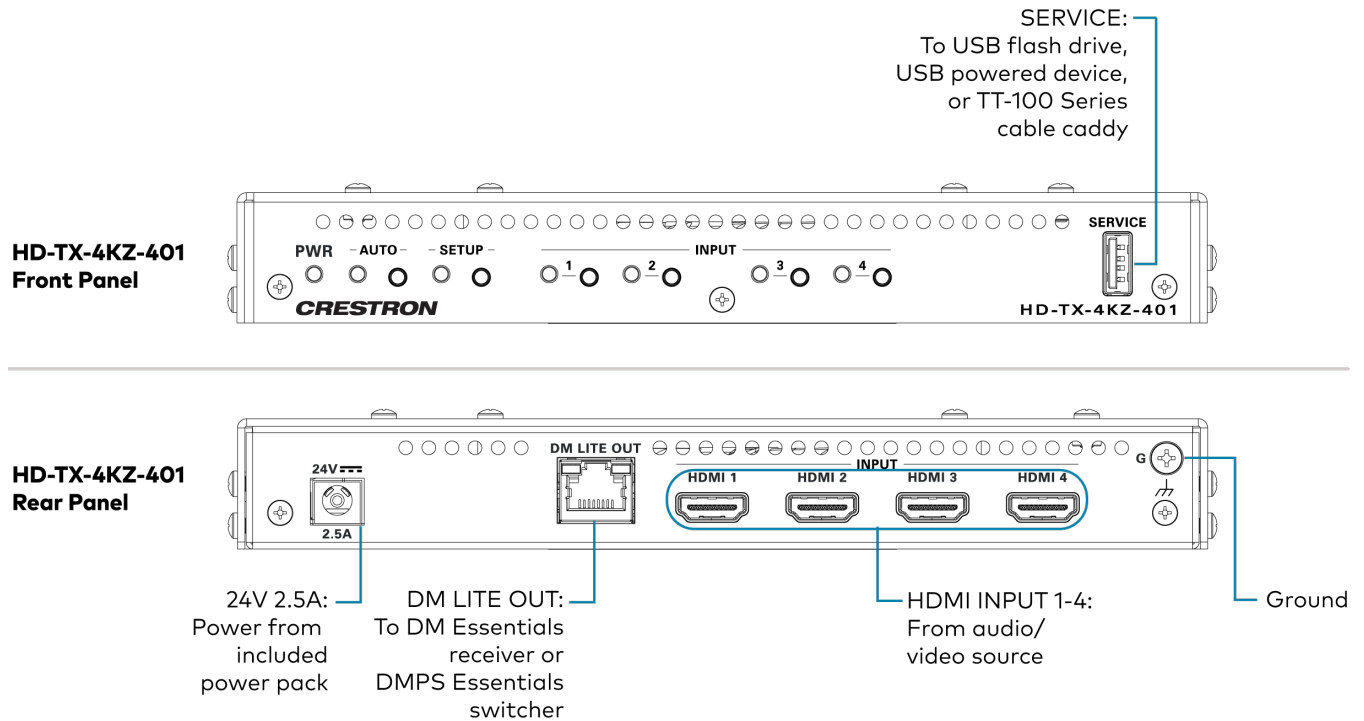

HD-TX-4KZ-421-CHGR Connections

Refer to the following illustration for general information about HD-TX-4KZ-421-CHGR front and rear panel connections.

NOTE: For guidelines regarding DM Essentials cabling, HDMI cabling, and the surface-mountable transmitter power connection, refer to [Installation Guidelines](#).

HD-TX-4KZ-421-CHGR Front and Rear Panel Connections

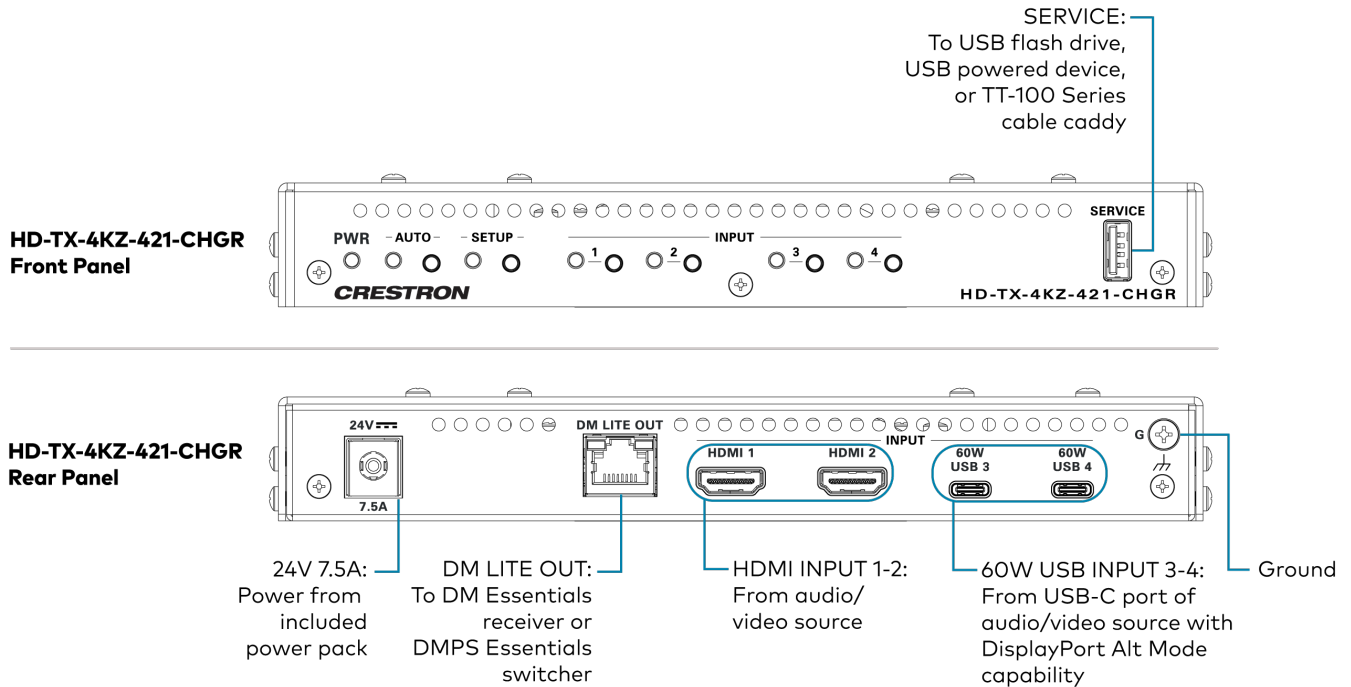

HD-TXU-4KZ-111-E Connections

Refer to the following illustration for general information about HD-TXU-4KZ-111-E front and rear panel connections.

NOTE: For guidelines regarding DM Essentials cabling and the surface-mountable transmitter power connection, refer to [Installation Guidelines](#).

HD-TXU-4KZ-111-E Front and Rear Panel Connections

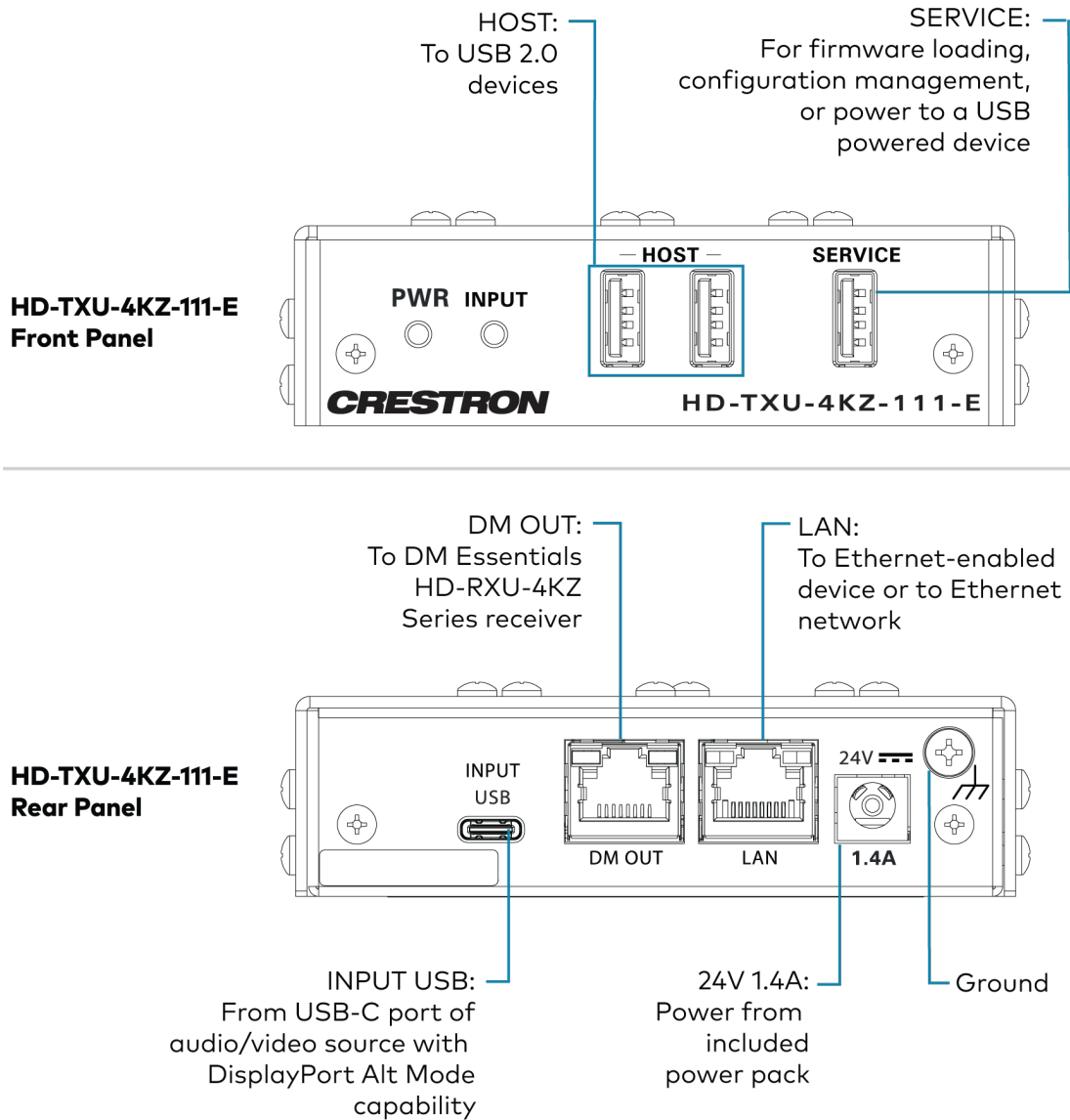

NOTE: If the HD-TXU-4KZ-111-E is paired with a DM Essentials receiver other than an HD-RXU-4KZ Series receiver or paired with a DMPS Essentials switcher (HD-PS Series or HD-RX-4K-210-C-E[-POE]), USB 2.0 data extension is not supported.

HD-TXU-4KZ-211 Connections

Refer to the following illustration for general information about HD-TXU-4KZ-211 front and rear panel connections.

NOTE: For guidelines regarding DM Essentials cabling, HDMI cabling, and the surface-mountable transmitter power connection, refer to [Installation Guidelines](#).

HD-TXU-4KZ-211 Front and Rear Panel Connections

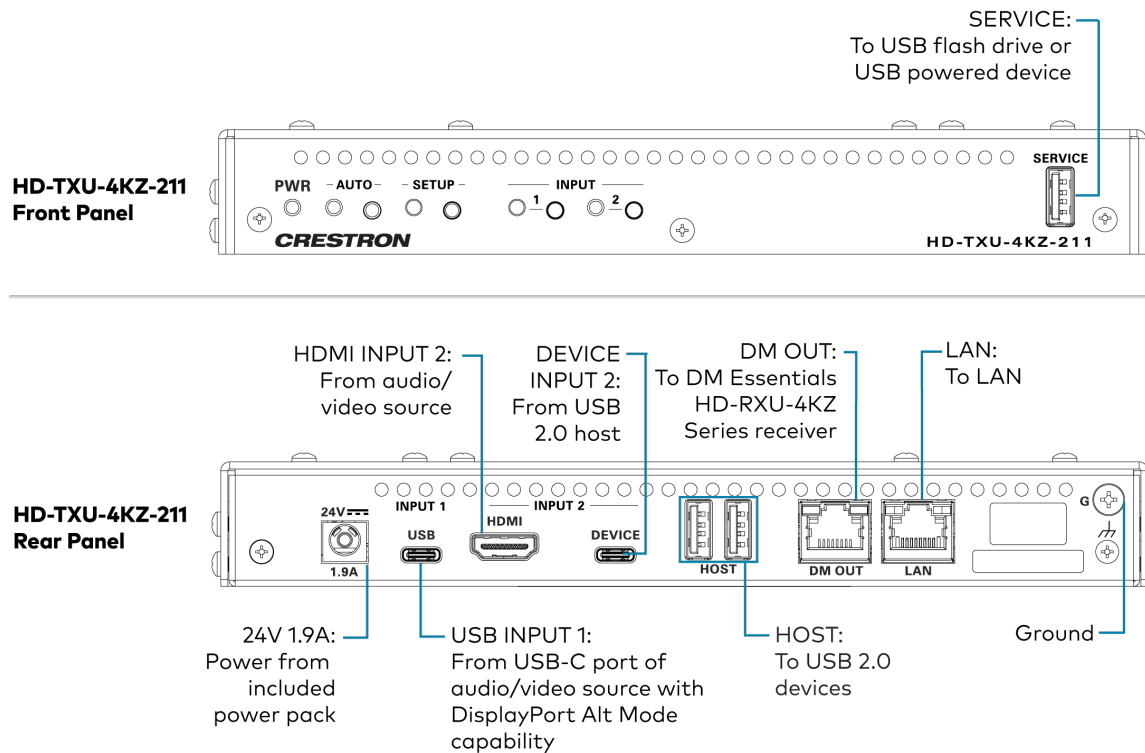

NOTE: If the HD-TXU-4KZ-211 is paired with a DM Essentials receiver other than an HD-RXU-4KZ Series receiver or paired with a DMPS Essentials switcher (HD-PS Series or HD-RX-4K-210-C-E[-POE]), USB 2.0 data extension is not supported.

HD-TXU-4KZ-211-CHGR Connections

Refer to the following illustration for general information about HD-TXU-4KZ-211-CHGR front and rear panel connections.

NOTE: For guidelines regarding DM Essentials cabling, HDMI cabling, and the surface-mountable transmitter power connection, refer to [Installation Guidelines](#).

HD-TXU-4KZ-211-CHGR Front and Rear Panel Connections

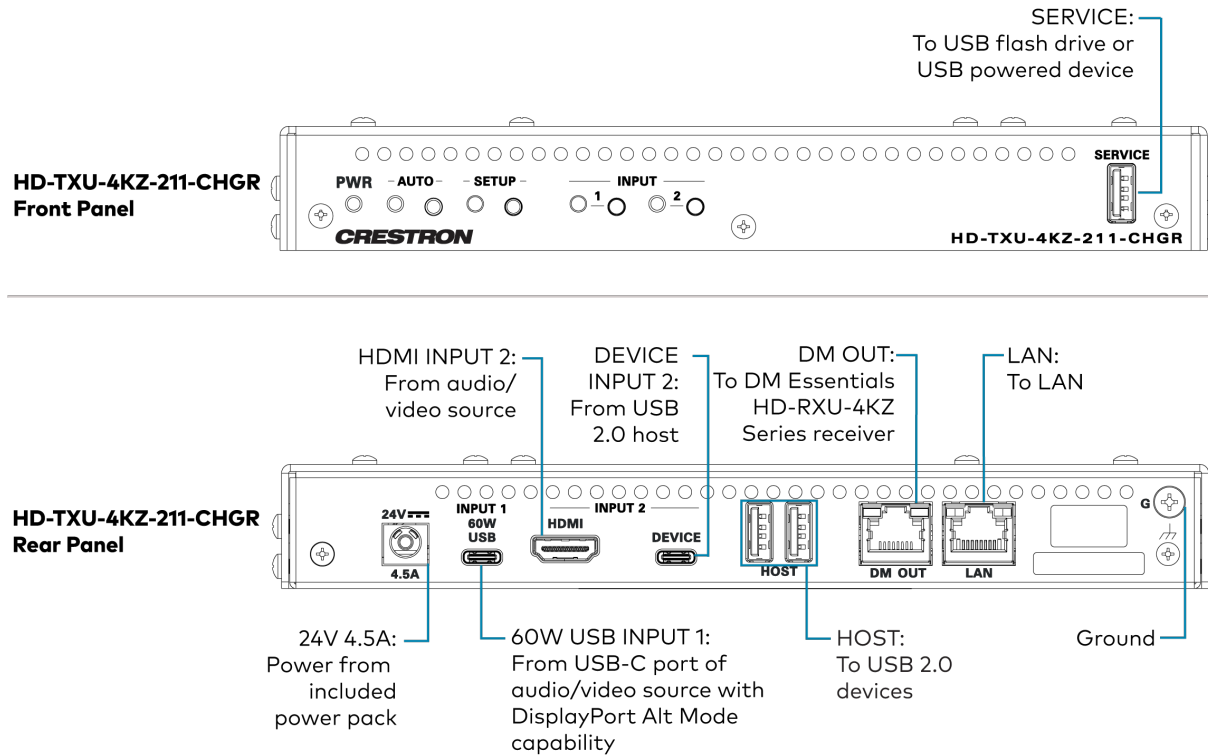

NOTE: If the HD-TXU-4KZ-211-CHGR is paired with a DM Essentials receiver other than an HD-RXU-4KZ Series receiver or paired with a DMPS Essentials switcher (HD-PS Series or HD-RX-4K-210-C-E[-POE]), USB 2.0 data extension is not supported.

Surface-Mountable Receiver Connections

This section provides information about making connections to the following surface-mountable receivers:

- [HD-RX-4KZ-101](#)
- [HD-RXA-4KZ-101](#)
- [HD-RXC-4KZ-101](#)
- [HD-RXCA-4KZ-101](#)
- [HD-RXU-4KZ-101-E](#)
- [HD-RXU-4KZ-202](#)

HD-RX-4KZ-101 Connections

Refer to the following illustration for general information about HD-RX-4KZ-101 rear panel connections.

NOTE: For guidelines regarding DM Essentials cabling, HDMI cabling, and the surface-mountable receiver power connection, refer to [Installation Guidelines](#).

HD-RX-4KZ-101 Rear Panel Connections

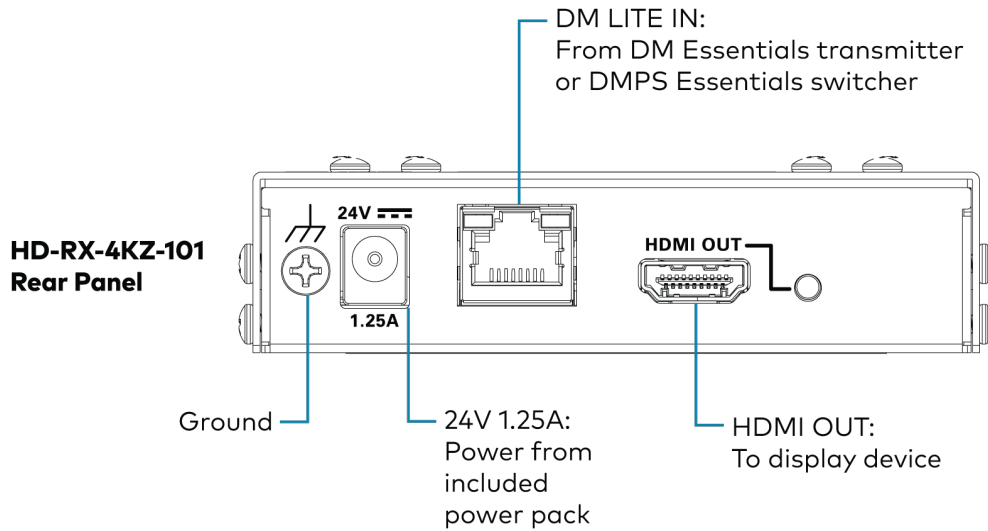

HD-RXA-4KZ-101 Connections

Refer to the following illustration for general information about HD-RXA-4KZ-101 front and rear panel connections.

NOTE: For guidelines regarding DM Essentials cabling, HDMI cabling, and the surface-mountable receiver power connection, refer to [Installation Guidelines](#).

HD-RXA-4KZ-101 Front and Rear Panel Connections

HD-RXA-4KZ-101 Front Panel

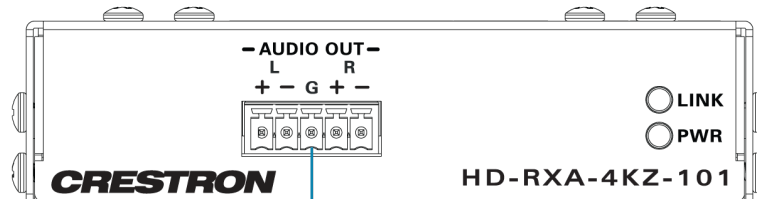

AUDIO OUT:
Balanced/unbalanced
stereo line level
audio output

HD-RXA-4KZ-101 Rear Panel

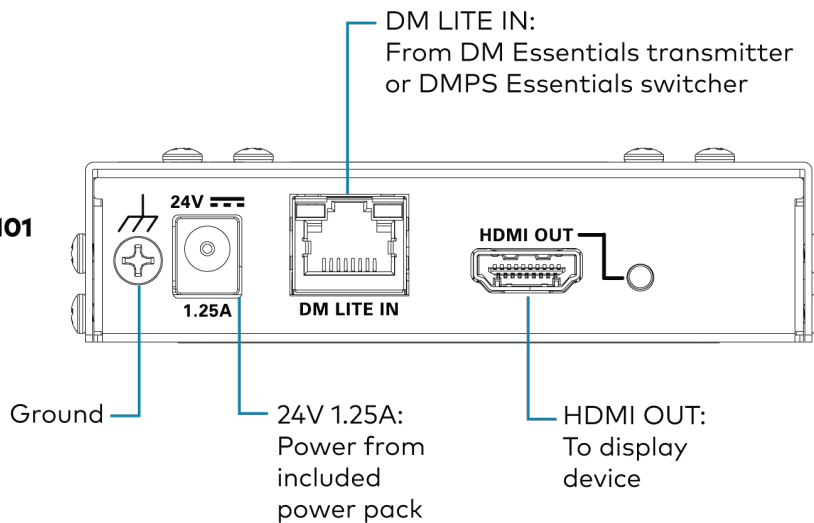

The front panel of the device includes a 5-pin terminal block connector for balanced or unbalanced analog audio output. Refer to the following table and diagrams for pin assignments and connection information.

Analog Audio Output Pin Assignments

Signal Name	Balanced Audio Output	Unbalanced Audio Output
+	L+	L+ Out
-	L-	Open
G	Shield/ground	Common ground
+	R+	R+ Out
-	R-	Open

Balanced Output

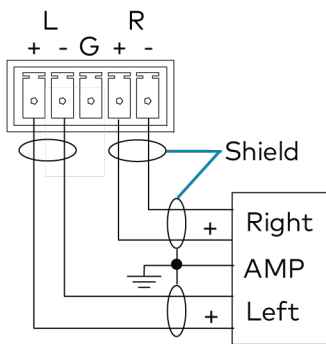

Unbalanced Output

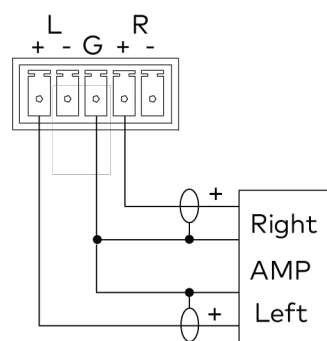

HD-RXC-4KZ-101 Connections

Refer to the following illustration for general information about HD-RXC-4KZ-101 front and rear panel connections.

NOTE: For guidelines regarding DM Essentials cabling, HDMI cabling, and the surface-mountable receiver power connection, refer to [Installation Guidelines](#).

HD-RXC-4KZ-101 Front and Rear Panel Connections

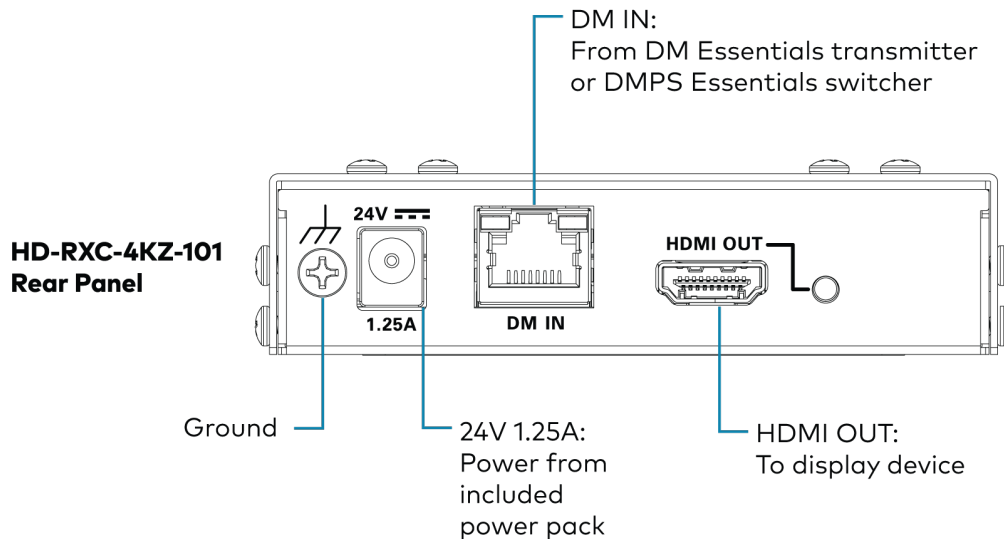
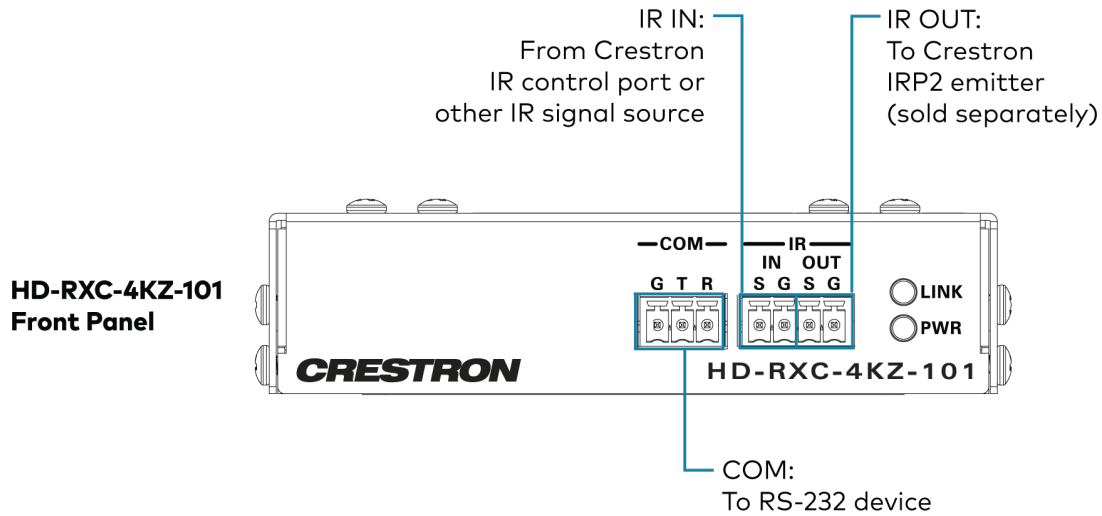

HD-RXCA-4KZ-101 Connections

Refer to the following illustration for general information about HD-RXCA-4KZ-101 front and rear panel connections.

NOTE: For guidelines regarding DM Essentials cabling, HDMI cabling, and the surface-mountable receiver power connection, refer to [Installation Guidelines](#).

HD-RXCA-4KZ-101 Front and Rear Panel Connections

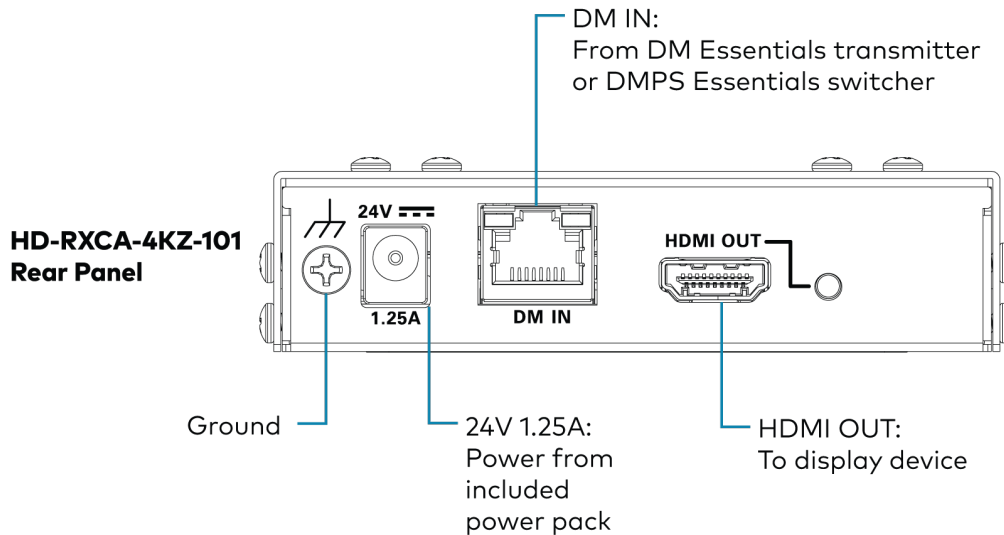
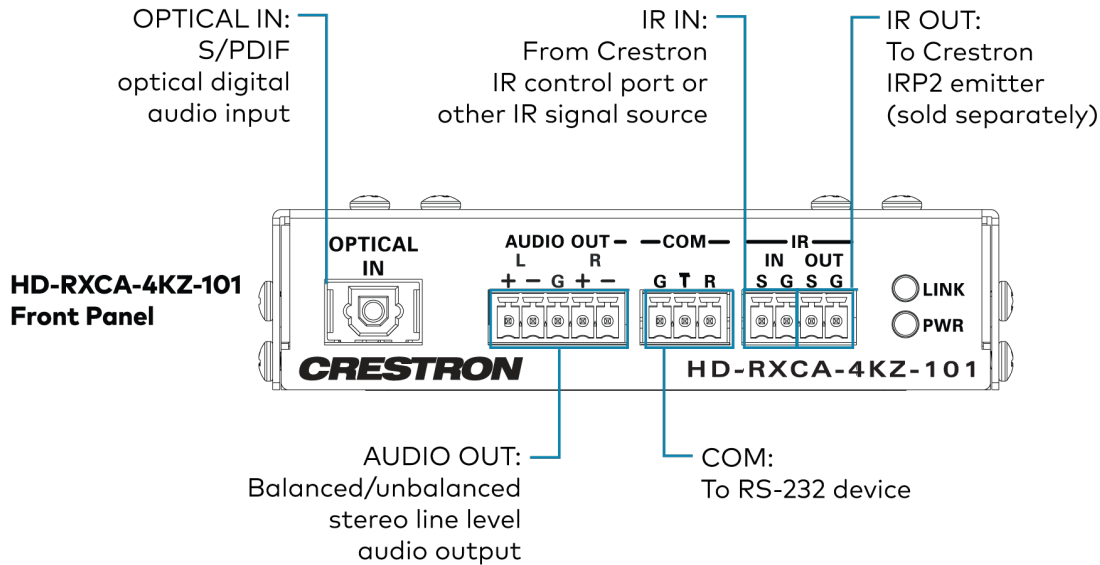

The front panel of the device includes a 5-pin terminal block connector for balanced or unbalanced analog audio output. Refer to the following table and diagrams for pin assignments and connection information.

Analog Audio Output Pin Assignments

Signal Name	Balanced Audio Output	Unbalanced Audio Output
+	L+	L+ Out
-	L-	Open
G	Shield/ground	Common ground
+	R+	R+ Out
-	R-	Open

Balanced Output

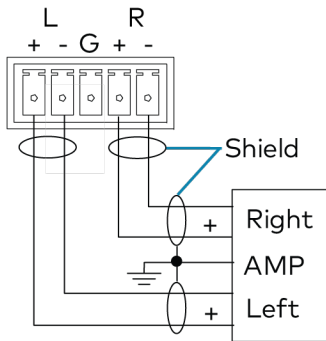

Unbalanced Output

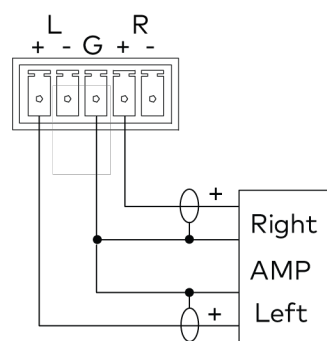

HD-RXU-4KZ-101-E Connections

Refer to the following illustration for general information about HD-RXU-4KZ-101-E front and rear panel connections.

NOTE: For guidelines regarding DM Essentials cabling, HDMI cabling, and the surface-mountable receiver power connection, refer to [Installation Guidelines](#).

HD-RXU-4KZ-101-E Front and Rear Panel Connections

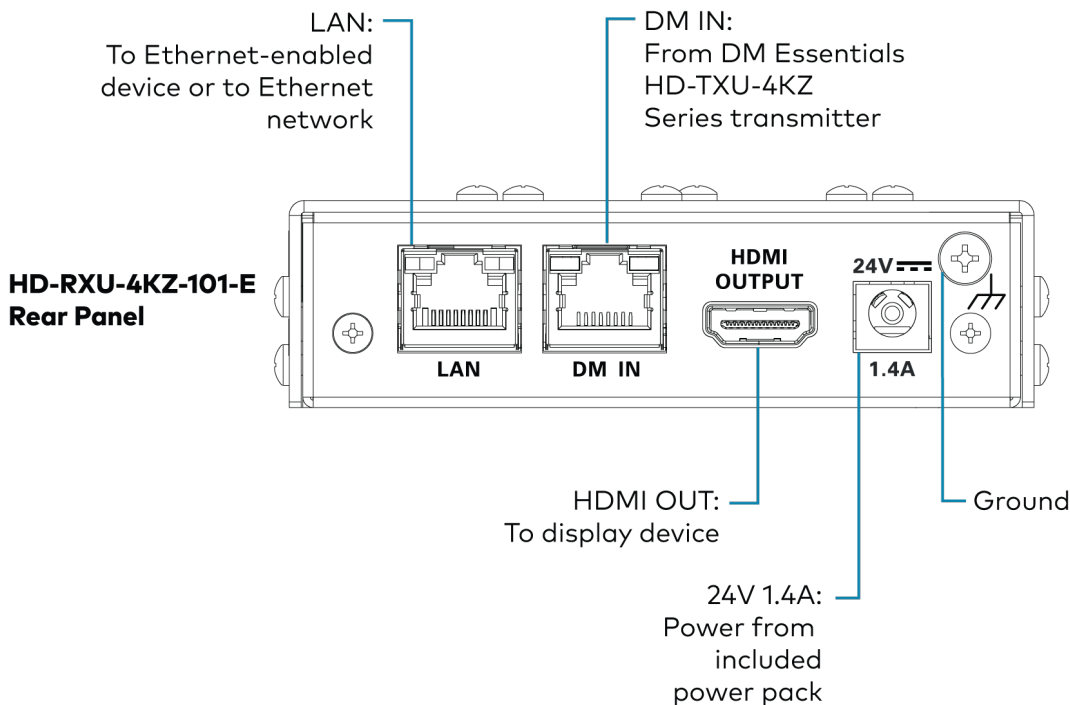
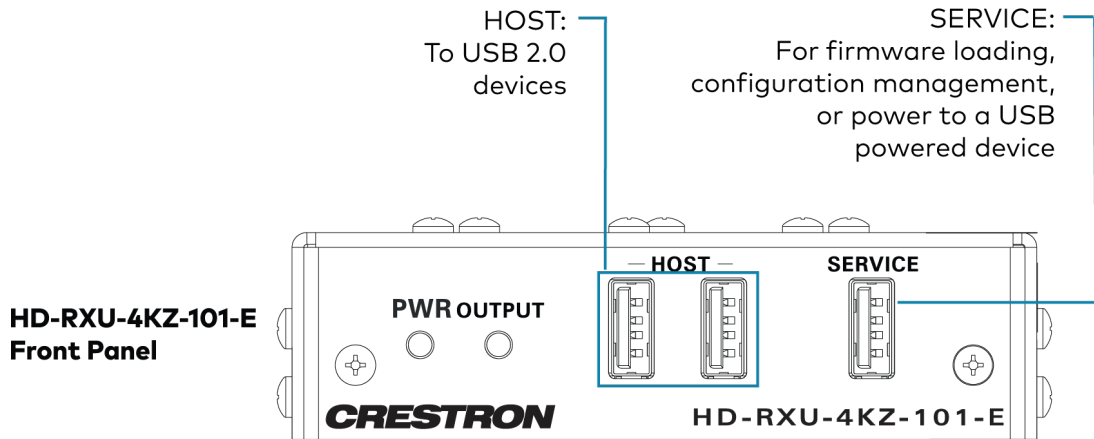

NOTE: If the HD-RXU-4KZ-101-E is paired with a DM Essentials transmitter other than an HD-TXU-4KZ Series transmitter or paired with a DMPS Essentials HD-PS Series switcher, USB 2.0 data extension is not supported.

HD-RXU-4KZ-202 Connections

Refer to the following illustration for general information about HD-RXU-4KZ-202 front and rear panel connections.

NOTE: For guidelines regarding DM Essentials cabling, HDMI cabling, and the surface-mountable receiver power connection, refer to [Installation Guidelines](#).

HD-RXU-4KZ-202 Front and Rear Panel Connections

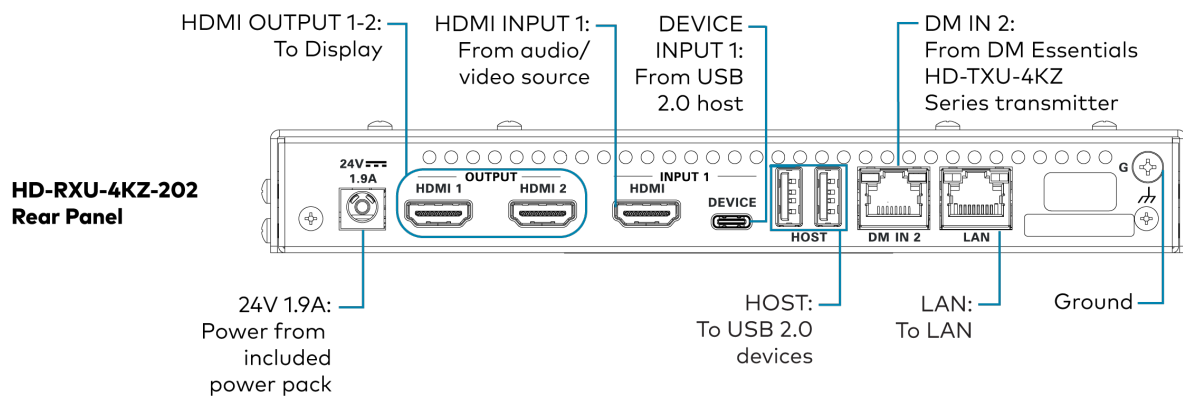
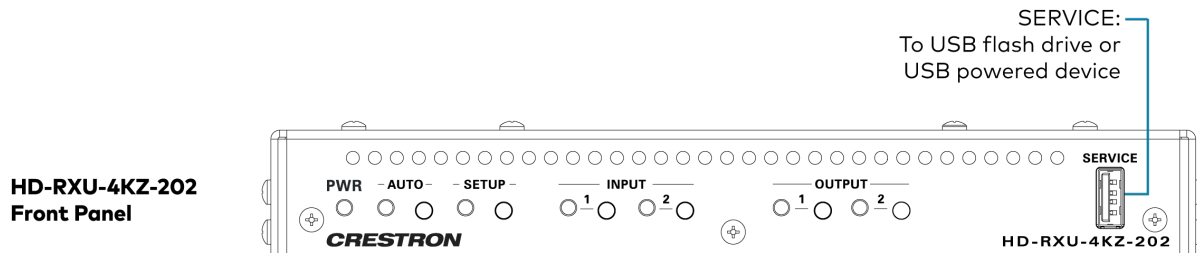

NOTE: If the HD-RXU-4KZ-202 is paired with a DM Essentials transmitter other than an HD-TXU-4KZ Series transmitter or paired with a DMPS Essentials HD-PS Series switcher, USB 2.0 data extension is not supported.

Wall Plate Device Installation

This section provides information about installing and making connections to DM Essentials wall plate transmitters and receivers.

In the Box

Qty.	Description
1	DM Essentials transmitter or receiver, wall plate
Additional Items	
HD-TX-4KZ-101-1G(-B, -W), HD-TX-4KZ-111-1G(-B, -W), and HD-RX-4KZ-101-1G-B Only	
2	Screw, 6-32 x 3/4 in. Truss Head, Combo (2009211)
HD-TXA-4KZ-101-1G-B Only	
2	Screw, 6-32 x 3/4 in. Truss Head, Combo (2009211)
1	Connector, 5-Pin (2003577)
HD-TXC-4KZ-101-1G-B Only	
2	Screw, 6-32 x 3/4 in. Truss Head, Combo (2009211)
1	Connector, 3-Pin (2003575)
1	Connector, 4-Pin (2003576)
1	Polycarbonate Overlay, TXC, Black (2064031)
HD-TXC-4KZ-101-1G-W Only	
2	Screw, 6-32 x 3/4 in. Truss Head, Combo (2009211)
1	Connector, 3-Pin (2003575)
1	Connector, 4-Pin (2003576)
1	Polycarbonate Overlay, TXC, White (2064032)
HD-RXC-4KZ-101-1G-B Only	
2	Screw, 6-32 x 3/4 in. Truss Head, Combo (2009211)
1	Connector, 3-Pin (2003575)
1	Connector, 4-Pin (2003576)

Qty.	Description
1	Polycarbonate Overlay, RXC, Black (2064030)
HD-TX-4KZ-211-2G(-B, -W), HD-TXU-4KZ-111-2G(-B, -W) and HD-RXU-4KZ-101-2G-B Only	
4	Screw, 6-32 x 3/4 in. Truss Head, Combo (2009211)

Installing a Wall Plate Device

A DM Essentials wall plate device can be mounted into an electrical box (not included) or onto a single rack rail.

Mounting into an Electrical Box

DM Essentials wall plate devices are either 1-gang or 2-gang devices. For installation instructions, refer to [Installing a 1-Gang Wall Plate Device](#) or [Installing a 2-Gang Wall Plate Device](#) as applicable to the DM Essentials device.

Installing a 1-Gang Wall Plate Device

To install a 1-gang wall plate device into an electrical box:

1. Verify that the required wiring has been fed through the electrical box, and then make connections to the rear of the device.

NOTE: For guidelines regarding DM Essentials cabling and the wall plate transmitter and receiver power connection, refer to [Installation Guidelines](#).

The following illustration provides general information about connections to the rear of HD-TX(A)(C)-4KZ-1x1-1G Series transmitters and HD-RX(C)-4KZ-101-1G Series receivers.

Connections to Rear of HD-TX(A)(C)-4KZ-1x1-1G Series Transmitter

HD-TX(A)(C)-4KZ-1x1-1G Series, Rear

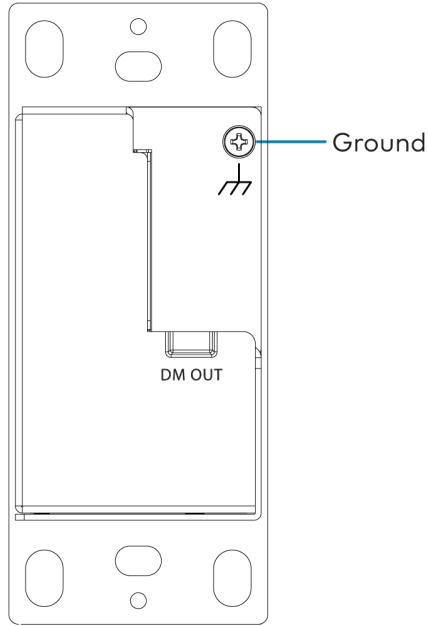

HD-TX(A)(C)-4KZ-1x1-1G Series, Rear, Top View

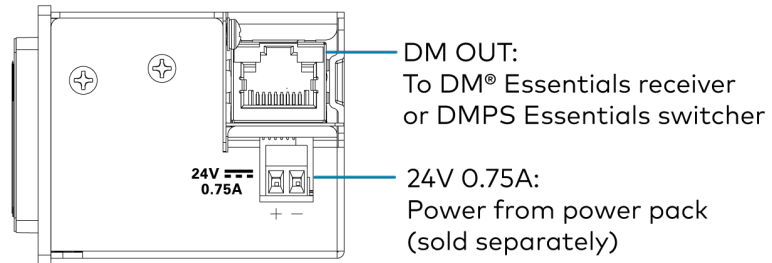

Connections to Rear of HD-RX(C)-4KZ-101-1G Series Receiver

HD-RX(C)-4KZ-101-1G Series, Rear

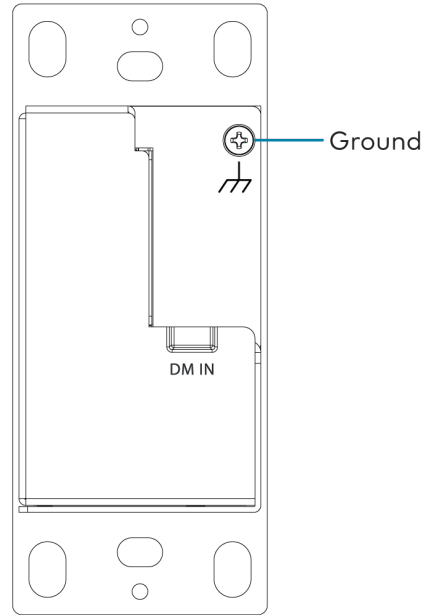

HD-RX(C)-4KZ-101-1G Series, Rear, Top View

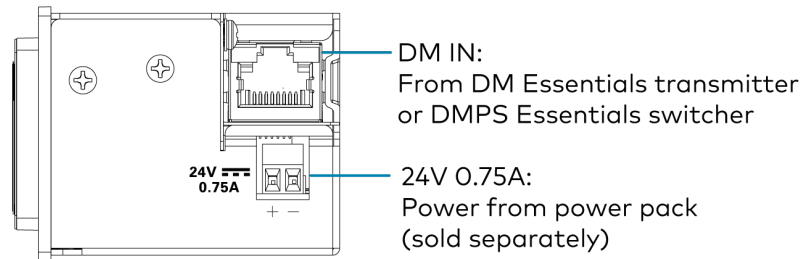

- Using a Phillips screwdriver (not included) and the two included 6-32 x 3/4-inch combo truss head screws, attach the device to the electrical box.

3. Attach the adhesive polycarbonate label to the front panel if the terminal block connectors are not in use (HD-TXC-4KZ-101-1G[-B, -W] and HD-RXC-4KZ-101-1G-B only).

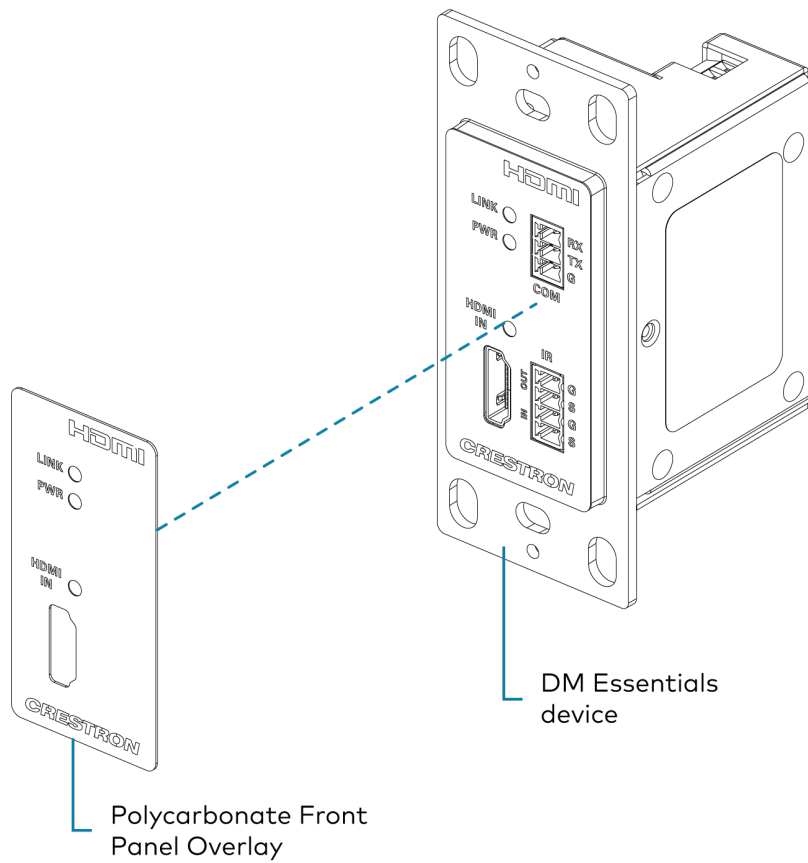

4. Attach a decorator style faceplate, such as the Crestron [FP-G1](#) (not included), to the front of the device using two screws (not included).

Mounting of 1-Gang Device into Electrical Box, HD-TX-4KZ-101-1G Shown

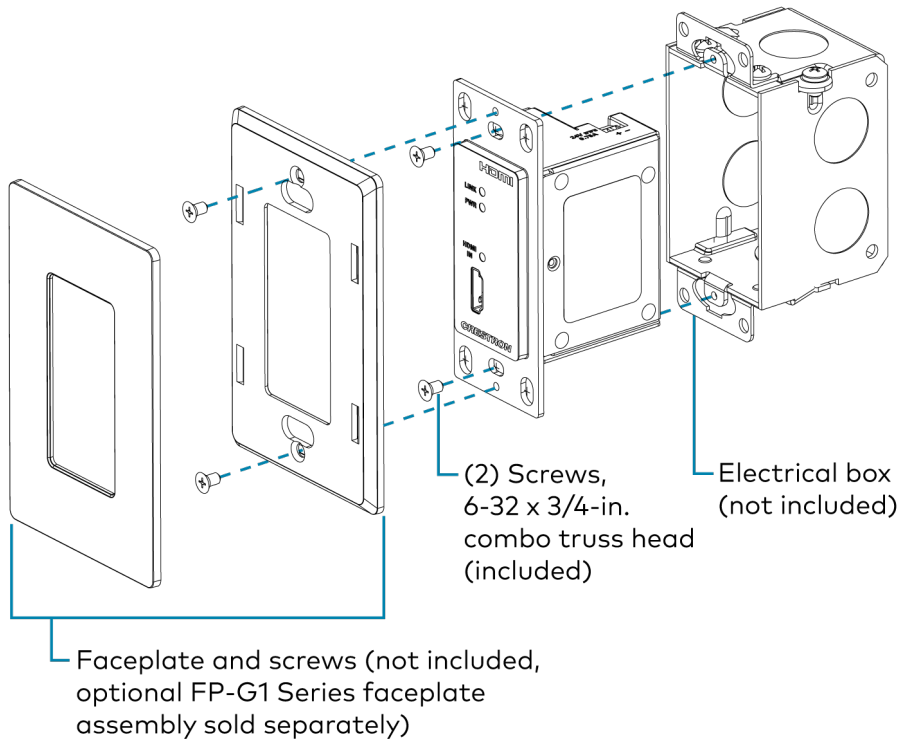

Installing a 2-Gang Wall Plate Device

To install a 2-gang wall plate device into an electrical box:

1. Verify that the required wiring has been fed through the electrical box, and then make connections to the rear of the device.

NOTE: For guidelines regarding DM Essentials cabling and the wall plate transmitter and receiver power connection, refer to [Installation Guidelines](#).

The following illustrations provide general information about connections to the rear of HD-TX-4KZ-211-2G and HD-TXU-4KZ-111-2G transmitters and to the rear of the HD-RXU-4KZ-101-2G receiver.

Connections to Rear of HD-TX-4KZ-211-2G

HD-TX-4KZ-211-2G Rear

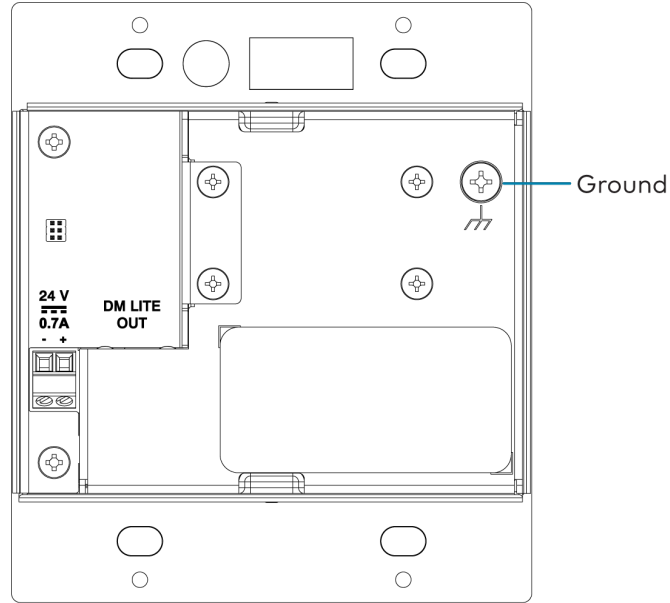

HD-TX-4KZ-211-2G Rear, Top View

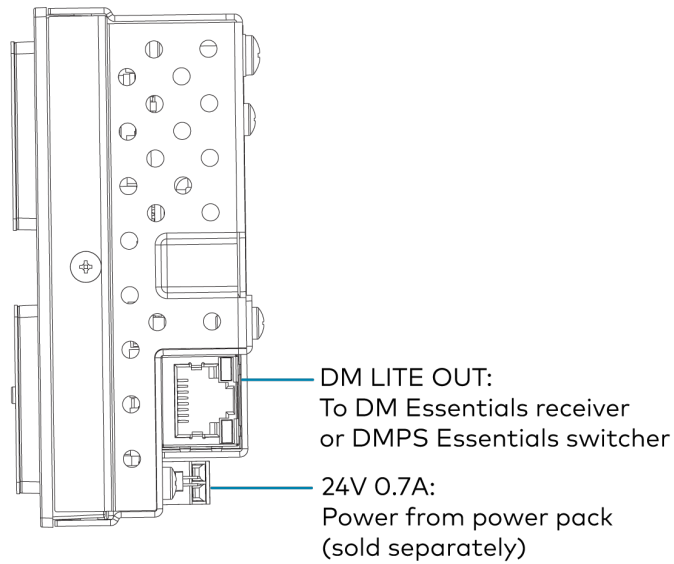

Connections to Rear of HD-TXU-4KZ-111-2G

HD-TXU-4KZ-111-2G Rear

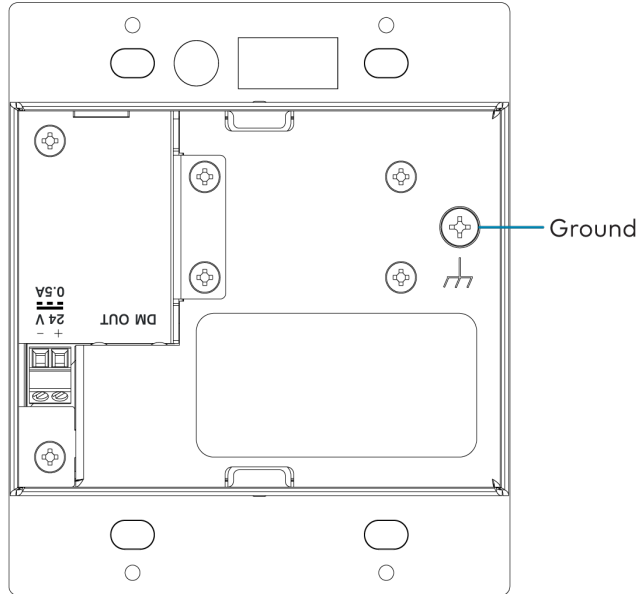

HD-TXU-4KZ-111-2G Rear, Top View

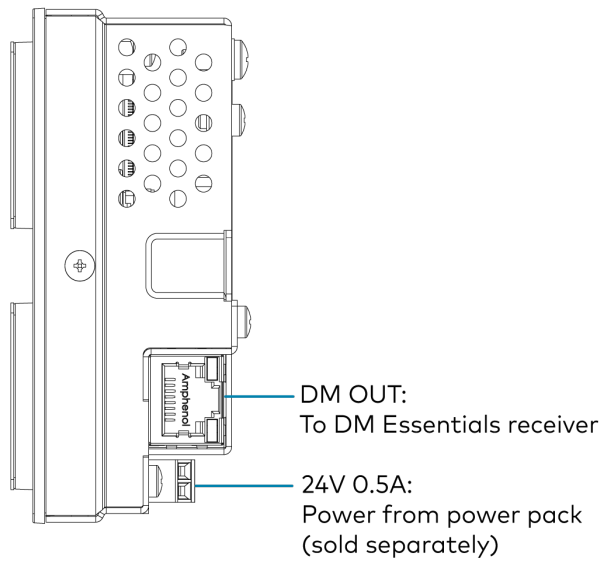

Connections to Rear of HD-RXU-4KZ-101-2G

HD-RXU-4KZ-101-2G Rear

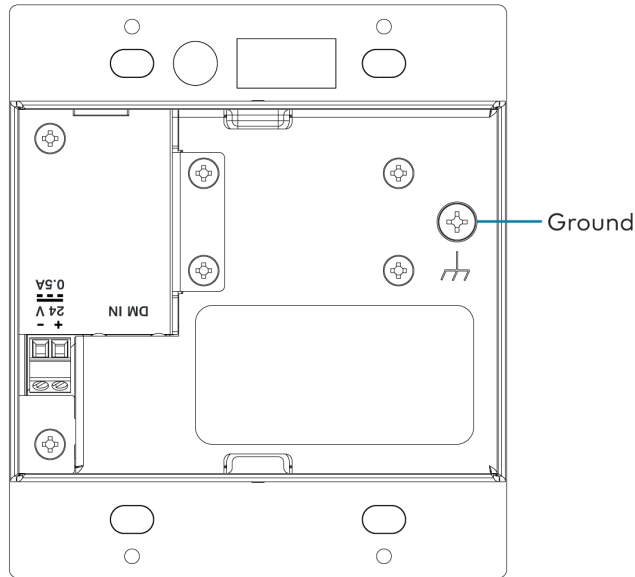

HD-RXU-4KZ-101-2G Rear, Top View

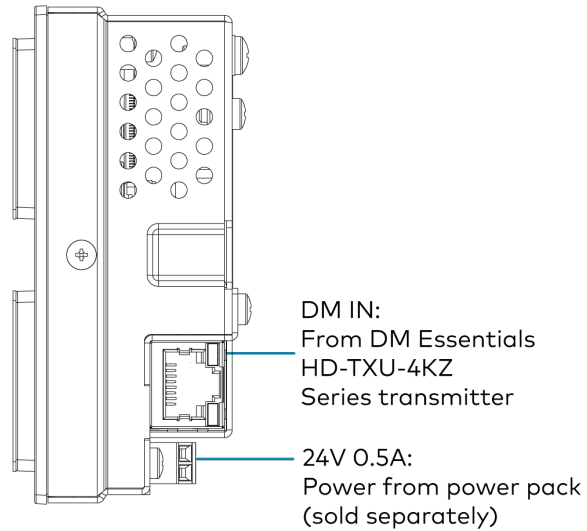

2. Using a Phillips screwdriver (not included) and the four included 6-32 x 3/4-inch combo truss head screws, attach the wall plate device to the electrical box.

3. Attach an FP-G2-DM Series decorator style faceplate (black [FP-G2-DM-B-T](#) or white [FP-G2-DM-W-T](#), sold separately) to the front of the device.

NOTE: An FP-G2-DM Series faceplate is required. Faceplates other than the FP-G2-DM Series are incompatible with DM Essentials 2-gang wall plate devices.

Mounting of 2-Gang Device into Electrical Box, HD-TX-4KZ-211-2G Shown

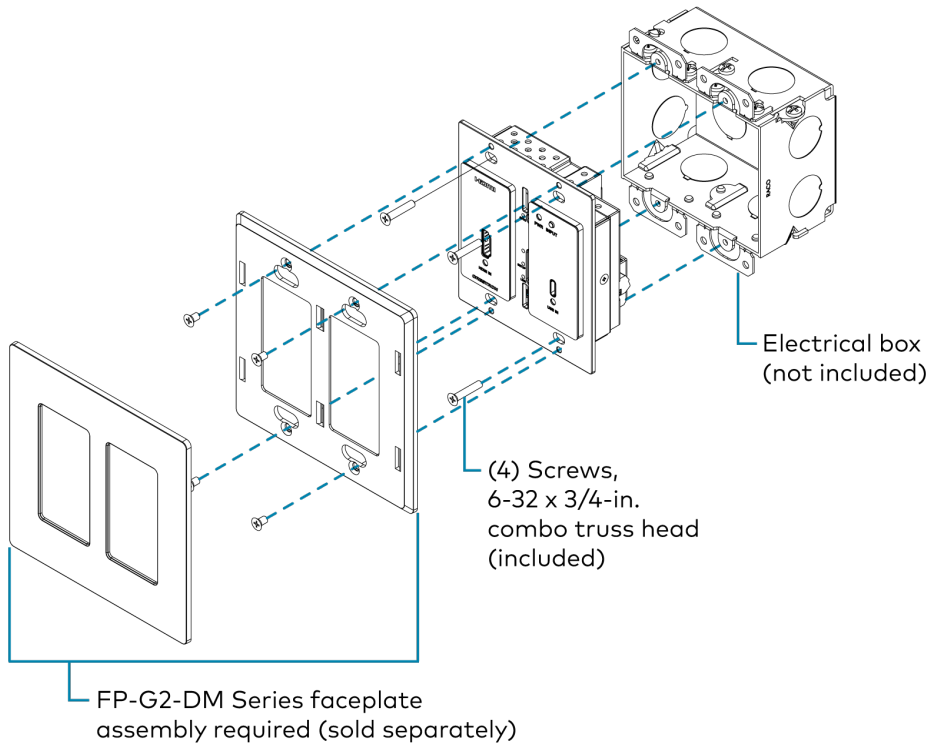

Mounting onto a Rack Rail

To mount a wall plate device onto a single rack rail:

1. Position the device horizontally so that the holes in the left or right mounting flange align with the holes in the rack rail.
2. Secure the device to the rack rail using two rack mount screws (not included).

For example purposes, mounting of the HD-TX-4KZ-101-1G onto a rack rail is shown in the following illustration.

Rack Rail Mounting, HD-TX-4KZ-101-1G Shown

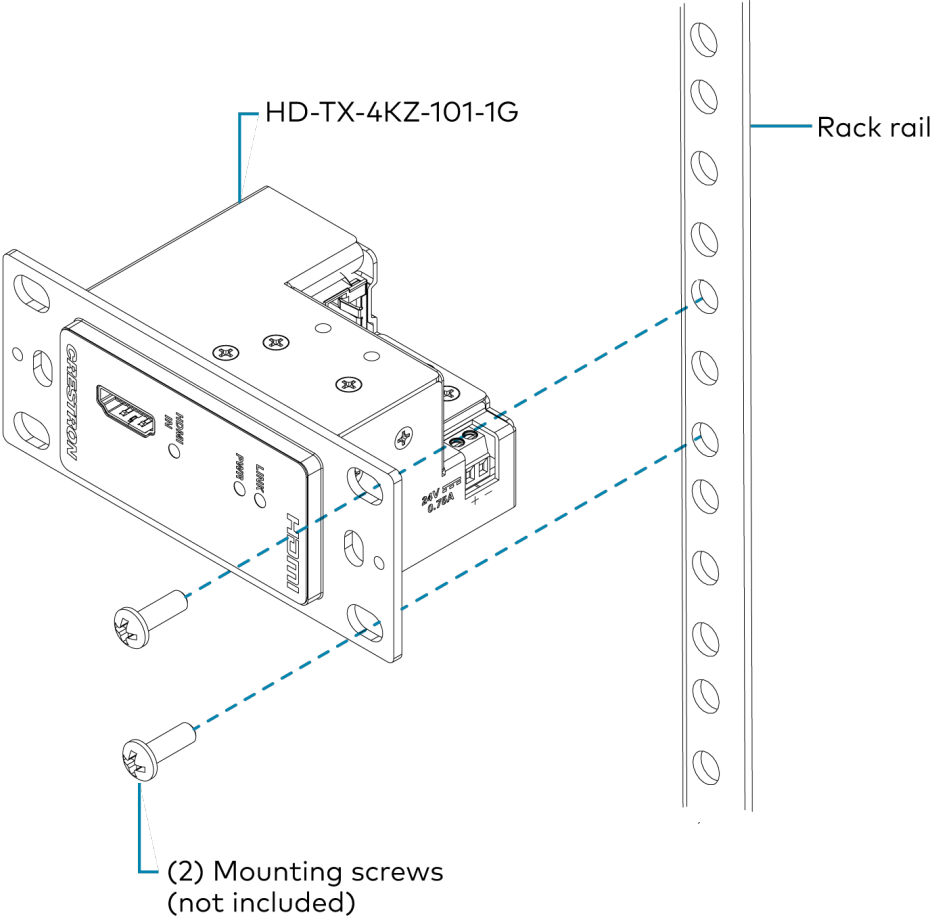

Connecting a Wall Plate Device

This section provides information about the following:

- [Wall plate transmitter connections](#)
- [Wall plate receiver connections](#)

Wall Plate Transmitter Connections

This section provides information about making connections to the following wall plate transmitters:

- [HD-TX-4KZ-101-1G](#)
- [HD-TXA-4KZ-101-1G](#)
- [HD-TXC-4KZ-101-1G](#)
- [HD-TX-4KZ-111-1G](#)
- [HD-TX-4KZ-211-2G](#)
- [HD-TXU-4KZ-111-2G](#)

HD-TX-4KZ-101-1G Connections

Refer to the following illustration for general information about connections to the front and rear of the HD-TX-4KZ-101-1G.

NOTE: For guidelines regarding DM Essentials cabling, HDMI cabling, and the wall plate transmitter power connection, refer to [Installation Guidelines](#).

HD-TX-4KZ-101-1G Connections, Front and Rear

**HD-TX-4KZ-101-1G,
Front**

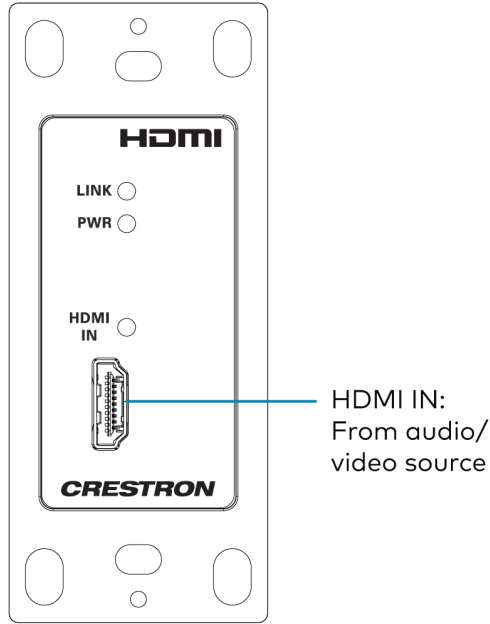

**HD-TX-4KZ-101-1G,
Rear**

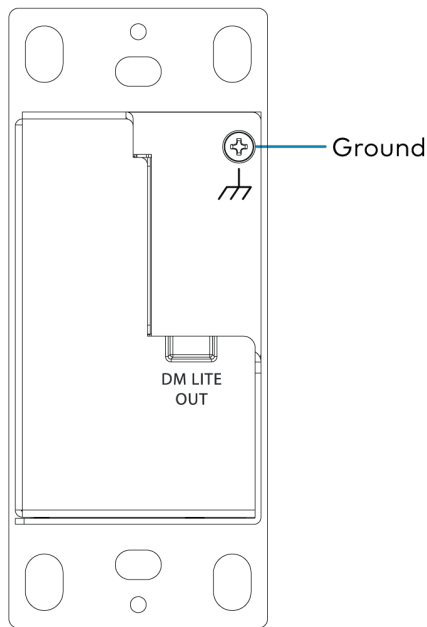

**HD-TX-4KZ-101-1G,
Rear, Top View**

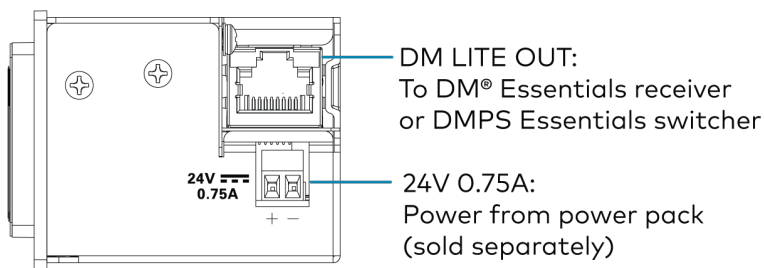

HD-TXA-4KZ-101-1G Connections

Refer to the following illustration for general information about connections to the front and rear of the HD-TXA-4KZ-101-1G.

NOTE: For guidelines regarding DM Essentials cabling, HDMI cabling, and the wall plate transmitter power connection, refer to [Installation Guidelines](#).

HD-TXA-4KZ-101-1G Connections, Front and Rear

HD-TXA-4KZ-101-1G, Front

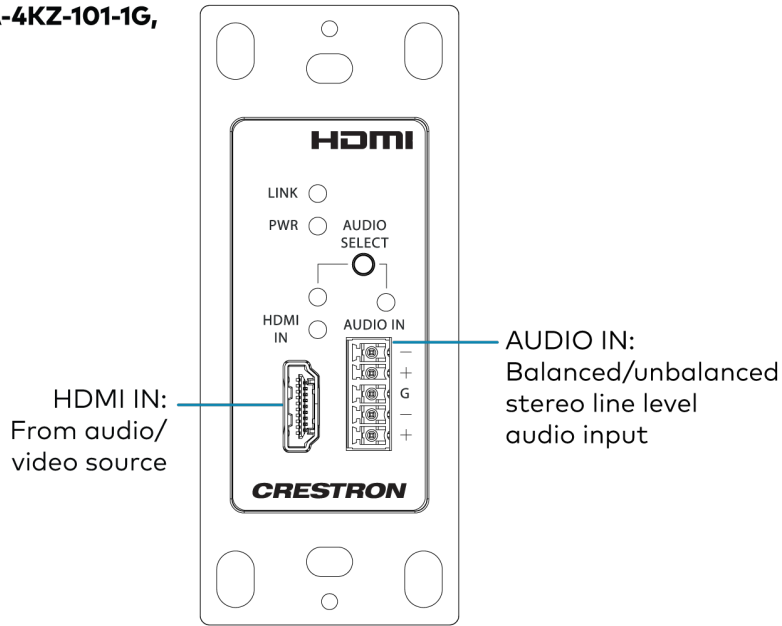

HD-TXA-4KZ-101-1G, Rear

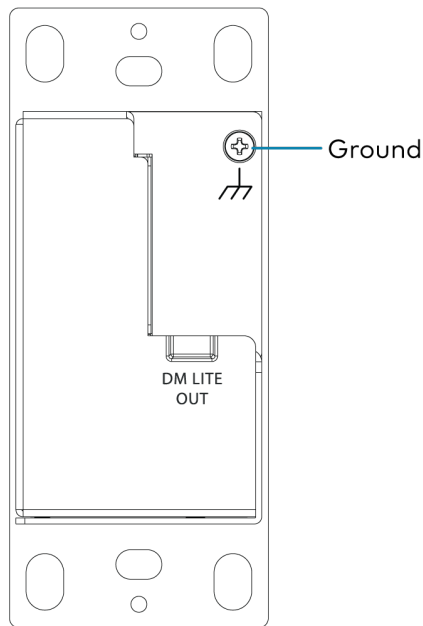

HD-TXA-4KZ-101-1G, Rear, Top View

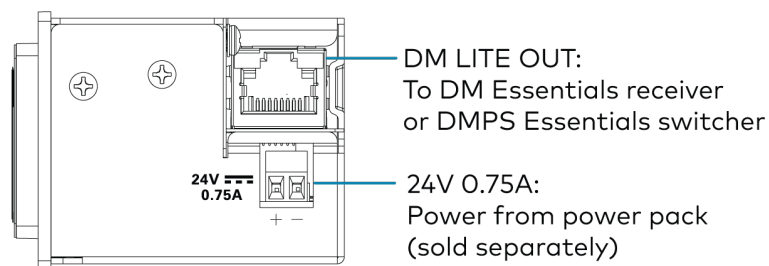

The front panel of the device includes a 5-pin terminal block connector for balanced or unbalanced analog audio input. Refer to the following table and diagram for pin assignments and connection information.

Analog Audio Input Pin Assignments

Signal Name	Balanced Audio Input	Unbalanced Audio Input
+	L+	L+ In
-	L-	L- Signal return, jumper to GND
G	Shield/ground	Ground
+	R+	R+ In
-	R-	R- Signal return, jumper to GND

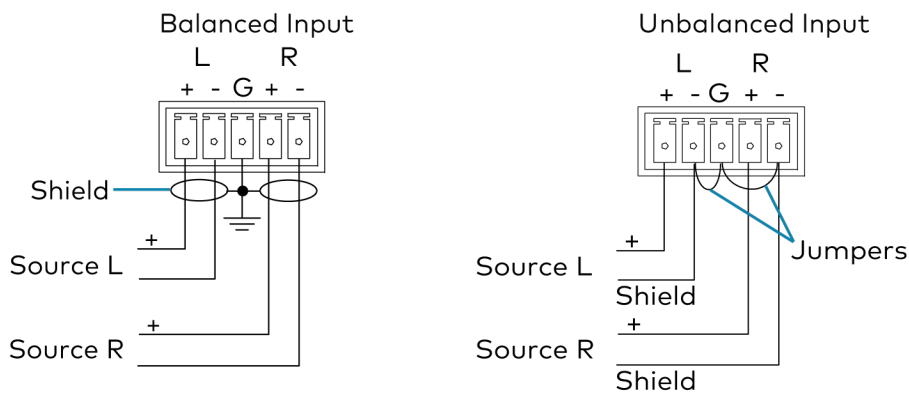

HD-TXC-4KZ-101-1G Connections

Refer to the following illustration for general information about connections to the front and rear of the HD-TXC-4KZ-101-1G.

NOTE: For guidelines regarding DM Essentials cabling, HDMI cabling, and the wall plate transmitter power connection, refer to [Installation Guidelines](#).

HD-TXC-4KZ-101-1G Connections, Front and Rear

HD-TXC-4KZ-101-1G, Front

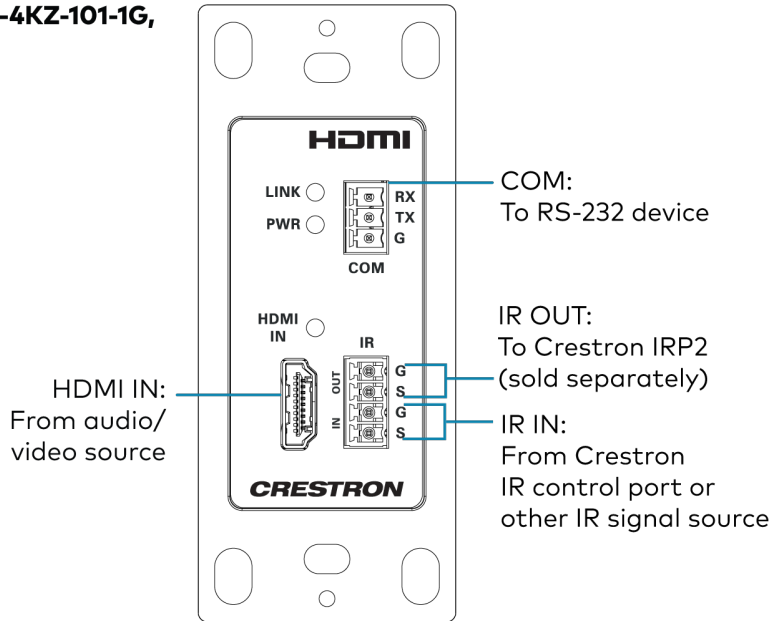

HD-TXC-4KZ-101-1G, Rear

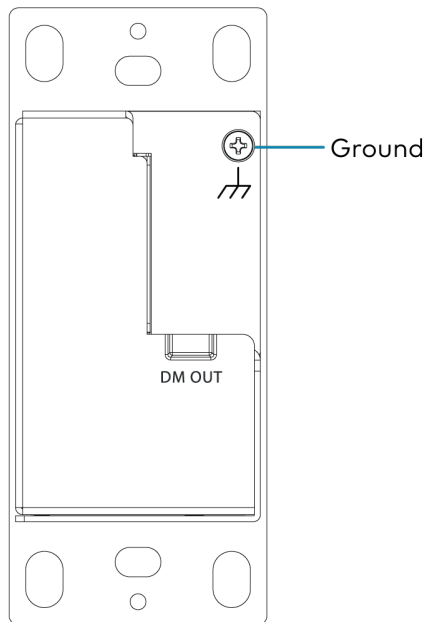

HD-TXC-4KZ-101-1G, Rear, Top View

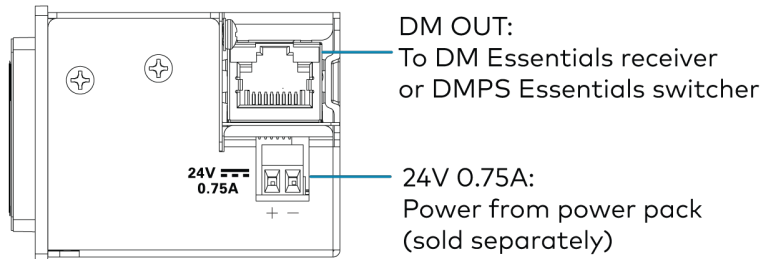

HD-TX-4KZ-111-1G Connections

Refer to the following illustration for general information about connections to the front and rear of the HD-TX-4KZ-111-1G.

NOTE: For guidelines regarding DM Essentials cabling and the wall plate transmitter power connection, refer to [Installation Guidelines](#).

HD-TX-4KZ-111-1G Connections, Front and Rear

**HD-TX-4KZ-111-1G,
Front**

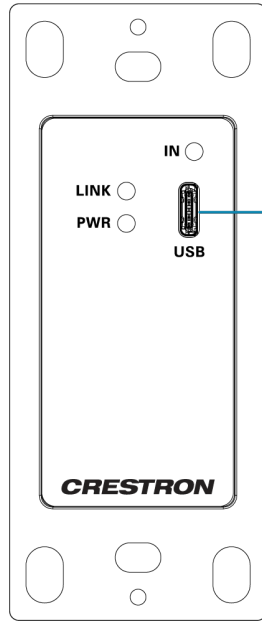

USB IN:
From USB-C port of
audio/video source with
DisplayPort Alt Mode
capability

**HD-TX-4KZ-111-1G,
Rear**

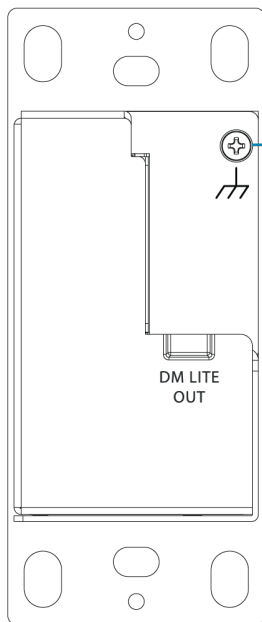

Ground

**HD-TX-4KZ-111-1G,
Rear, Top View**

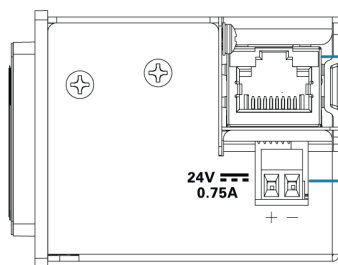

DM LITE OUT:
To DM Essentials receiver
or DMPS Essentials switcher

24V 0.75A:
Power from power pack
(sold separately)

HD-TX-4KZ-211-2G Connections

Refer to the following illustration for general information about connections to the front and rear of the HD-TX-4KZ-211-2G.

NOTE: For guidelines regarding DM Essentials cabling, HDMI cabling, and the wall plate transmitter power connection, refer to [Installation Guidelines](#).

HD-TX-4KZ-211-2G Connections, Front and Rear

HD-TX-4KZ-211-2G, Front

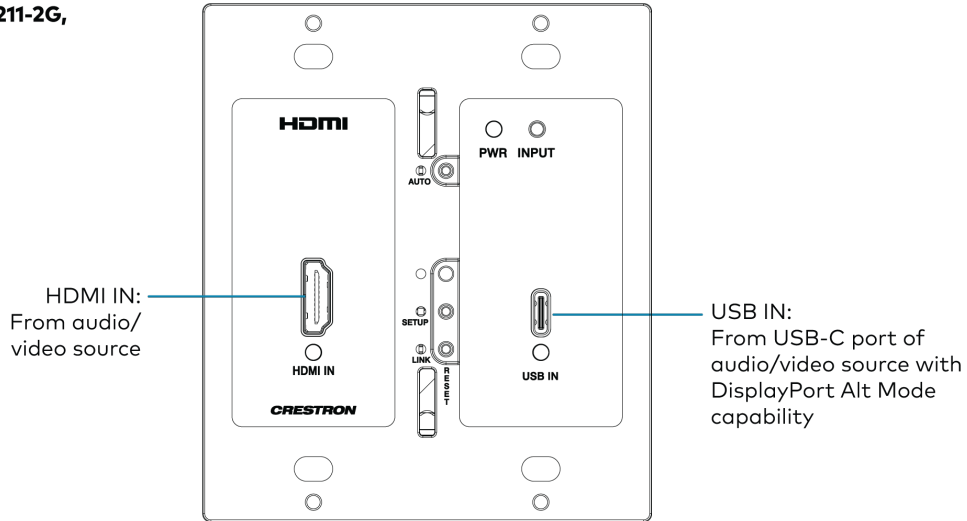

HD-TX-4KZ-211-2G, Rear

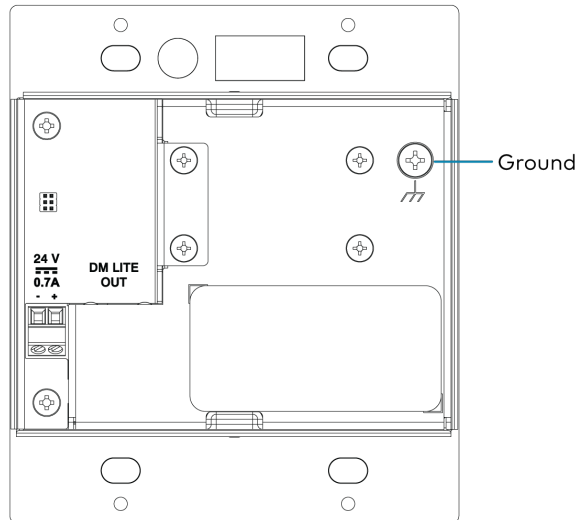

HD-TX-4KZ-211-2G, Rear, Top View

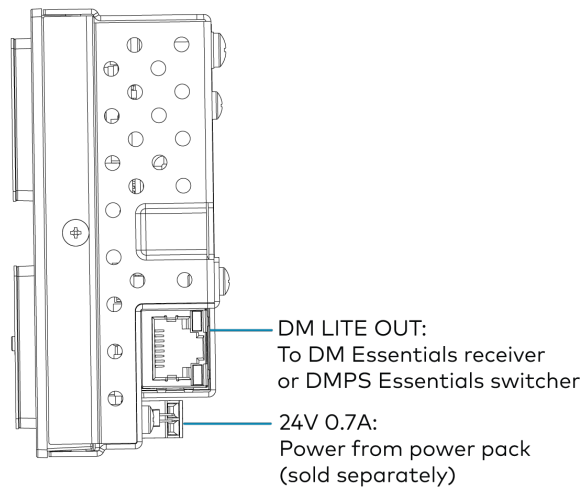

HD-TXU-4KZ-111-2G Connections

Refer to the following illustration for general information about connections to the front and rear of the HD-TXU-4KZ-111-2G.

NOTE: For guidelines regarding DM Essentials cabling and the wall plate transmitter power connection, refer to [Installation Guidelines](#).

HD-TXU-4KZ-111-2G Connections, Front and Rear

HD-TXU-4KZ-111-2G, Front

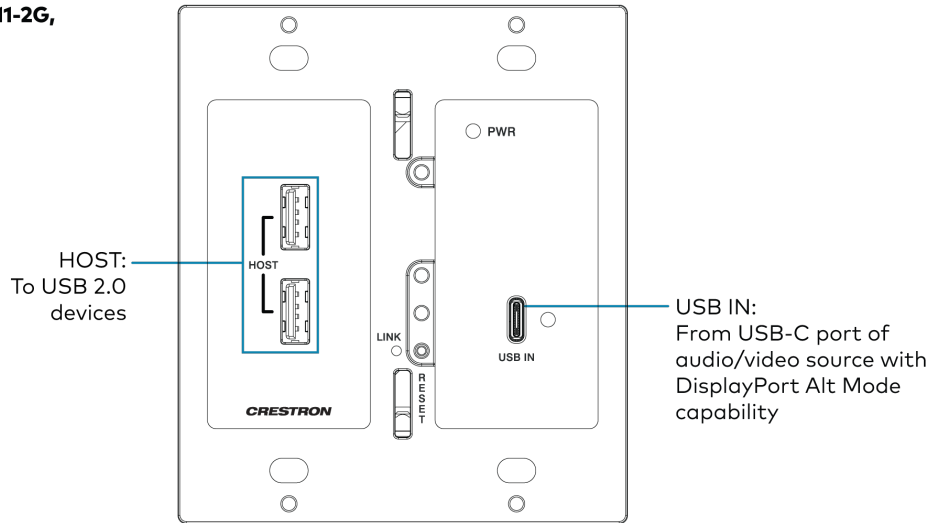

HD-TXU-4KZ-111-2G Rear

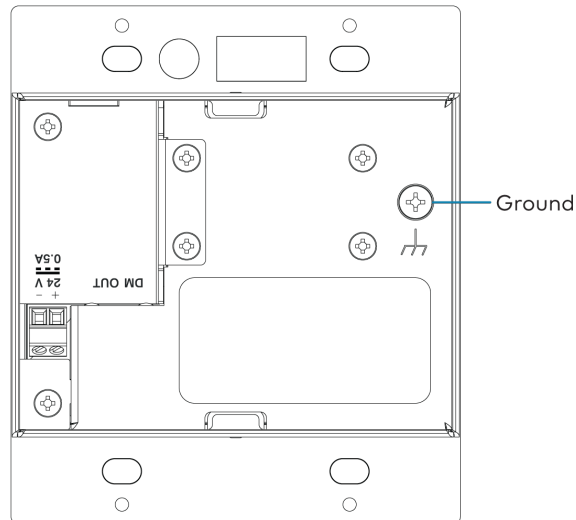

HD-TXU-4KZ-111-2G Rear, Top View

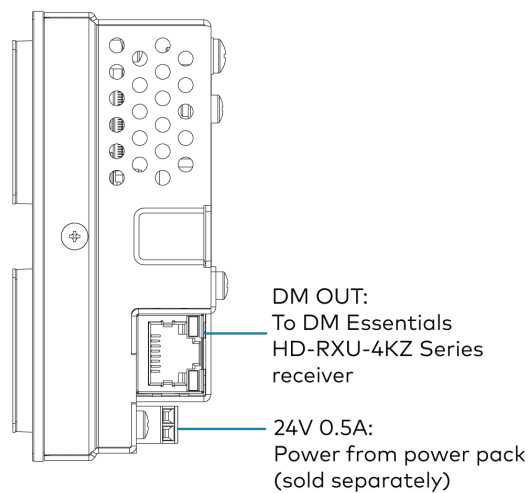

NOTE: If the HD-TXU-4KZ-111-2G is paired with a DM Essentials receiver other than an HD-RXU-4KZ Series receiver, USB data extension is not supported.

Wall Plate Receiver Connections

This section provides information about making connections to the following wall plate receivers:

- [HD-RX-4KZ-101-1G](#)
- [HD-RXC-4KZ-101-1G](#)
- [HD-RXU-4KZ-101-2G](#)

HD-RX-4KZ-101-1G Connections

Refer to the following illustration for general information about connections to the front and rear of the HD-RX-4KZ-101-1G.

NOTE: For guidelines regarding DM Essentials cabling, HDMI cabling, and the wall plate receiver power connection, refer to [Installation Guidelines](#).

HD-RX-4KZ-101-1G Connections, Front and Rear

HD-RX-4KZ-101-1G, Front

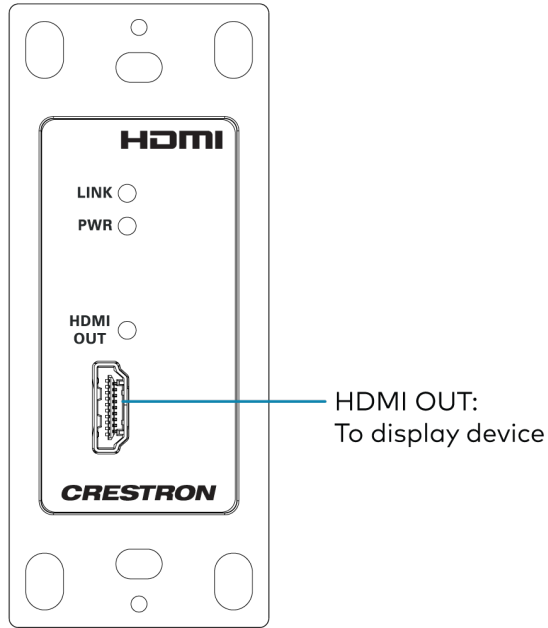

HD-RX-4KZ-101-1G, Rear

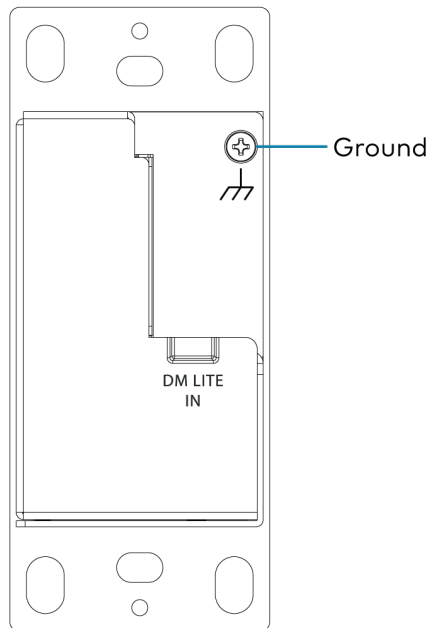

HD-RX-4KZ-101-1G, Rear, Top View

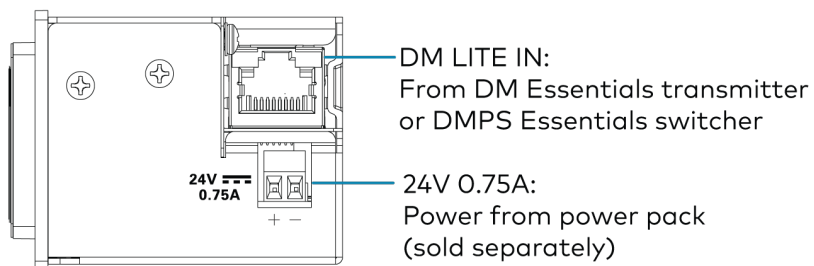

HD-RXC-4KZ-101-1G Connections

Refer to the following illustration for general information about connections to the front and rear of the HD-RXC-4KZ-101-1G.

NOTE: For guidelines regarding DM Essentials cabling, HDMI cabling, and the wall plate receiver power connection, refer to [Installation Guidelines](#).

HD-RXC-4KZ-101-1G Connections, Front and Rear

HD-RXC-4KZ-101-1G, Front

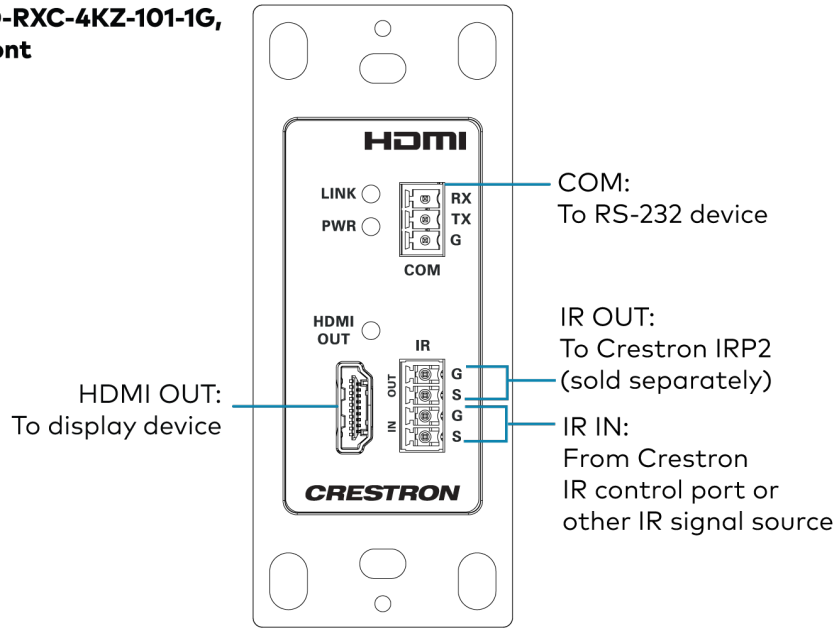

HD-RXC-4KZ-101-1G, Rear

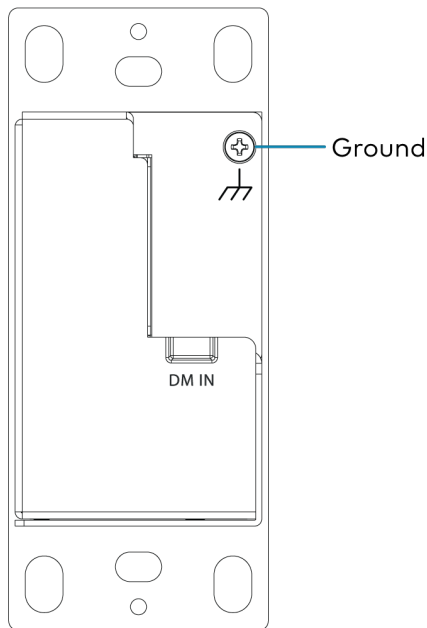

HD-RXC-4KZ-101-1G, Rear, Top View

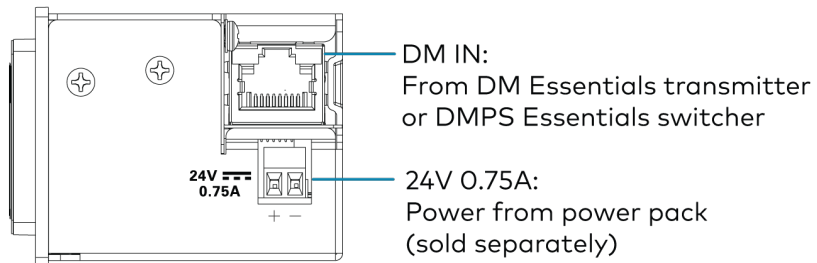

HD-RXU-4KZ-101-2G Connections

Refer to the following illustration for general information about connections to the front and rear of the HD-RXU-4KZ-101-2G.

NOTE: For guidelines regarding DM Essentials cabling, HDMI cabling, and the wall plate receiver power connection, refer to [Installation Guidelines](#).

HD-RXU-4KZ-101-2G Connections, Front and Rear

HD-RXU-4KZ-101-2G, Front

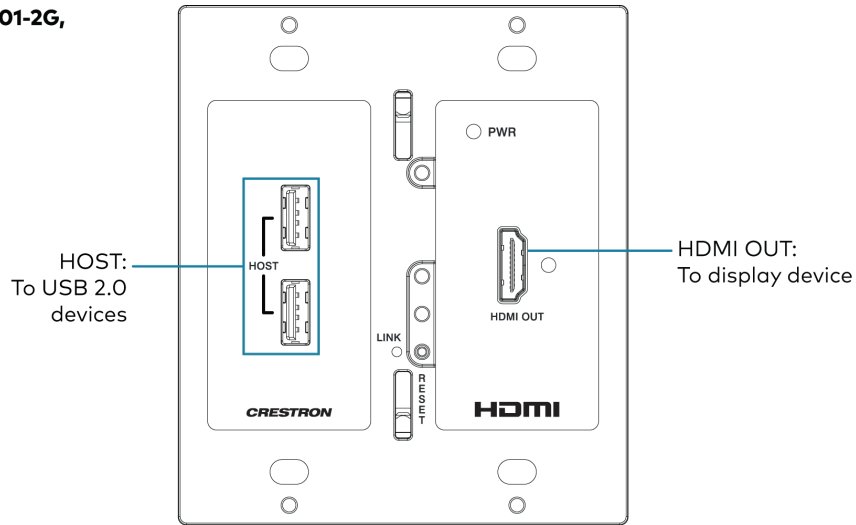

HD-RXU-4KZ-101-2G, Rear

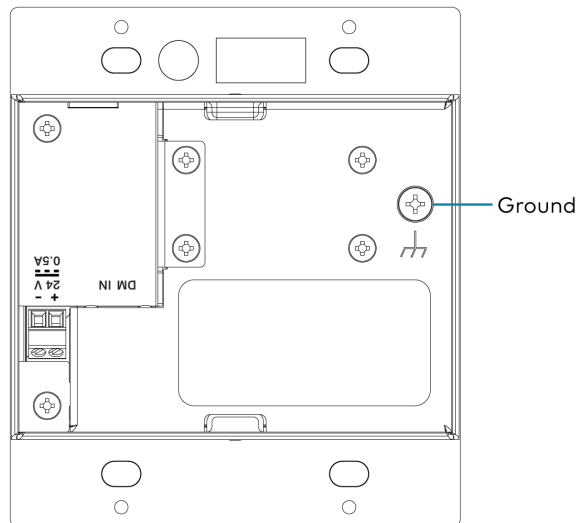

HD-RXU-4KZ-101-2G, Rear, Top View

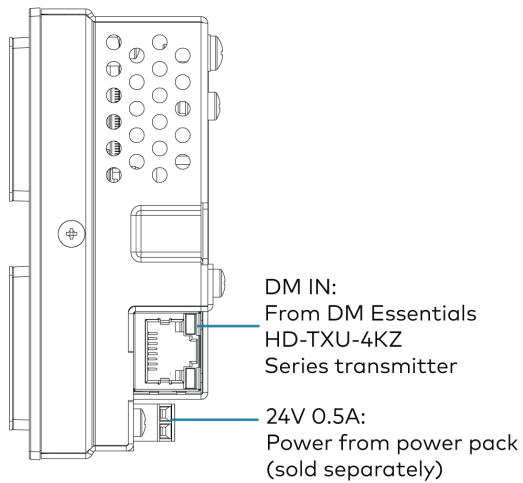

NOTE: If the HD-RXU-4KZ-101-2G is paired with a DM Essentials transmitter other than an HD-TXU-4KZ Series transmitter, USB data extension is not supported.

Configuration

NOTES:

- This section applies to the HD-TXU-4KZ-211, HD-TXU-4KZ-211-CHGR, and HD-RXU-4KZ-202 only.
- Prior to configuration, ensure that the latest firmware is running on the device. For instructions to update the firmware, refer to [Updating Firmware](#) in the [Management](#) section of this manual.

The HD-TXU-4KZ-211(-CHGR) and HD-RXU-4KZ-202 include an integrated web server that provides a web interface. Using the web interface, the device and connected DM Essentials USB 2.0 transmitters and receivers can be configured and managed. Status information can also be viewed.

NOTE: When an HD-TXU-4KZ-211(-CHGR) is connected to an HD-RXU-4KZ-202 via the DM Essentials connection and the LAN port of the HD-RXU-4KZ-202 is connected to the LAN, the HD-RXU-4KZ-202 controls the HD-TXU-4KZ-211(-CHGR). In this configuration, be aware of the following:

- Connecting the LAN port of the HD-TXU-4KZ-211(-CHGR) to the LAN is optional and only recommended when updating firmware.
- Pressing the **SETUP** button on either the HD-RXU-4KZ-202 or the HD-TXU-4KZ-211(-CHGR) displays the IP address of the HD-RXU-4KZ-202.
- After a reboot of the HD-TXU-4KZ-211(-CHGR), **Copy Output x** EDID is displayed as **Copy Receiver Output x**.

This section provides information about the following:

- [Accessing the web interface](#)
- [Navigating the web interface](#)
- [Saving configuration changes](#)
- [Viewing status information](#)
- [Configuring setup and operational settings](#)
- [Configuring security settings](#)
- [Configuring IEEE 802.1X settings](#)

Accessing the Web Interface

The following table lists the supported operating systems and corresponding web browsers that can be used to access the web interface.

Supported Operating Systems and Corresponding Web Browsers

Operating System	Supported Web Browser
Windows® operating system	Chrome™ web browser, version 96.0.4664.110 or later Firefox® web browser, version 94.0.2 or later Microsoft Edge® web browser, version 96.0.1054.62 or later
macOS® operating system	Safari® web browser, version 14.0.3 or later

To access the web interface:

1. Using the Device Discovery tool in the Crestron Toolbox™ software, find the IP address of the DM Essentials device.
2. Open a web browser.
3. Go to the IP address of the DM Essentials device.

The Device Administration page opens:

- If no user account has been created, continue with step 4 to create an account.
 - If an account has already been created, omit step 4 and proceed to step 5.
4. If no user account has been created, create an account as indicated on the Device Administration page.

Device Administration Page - Create User

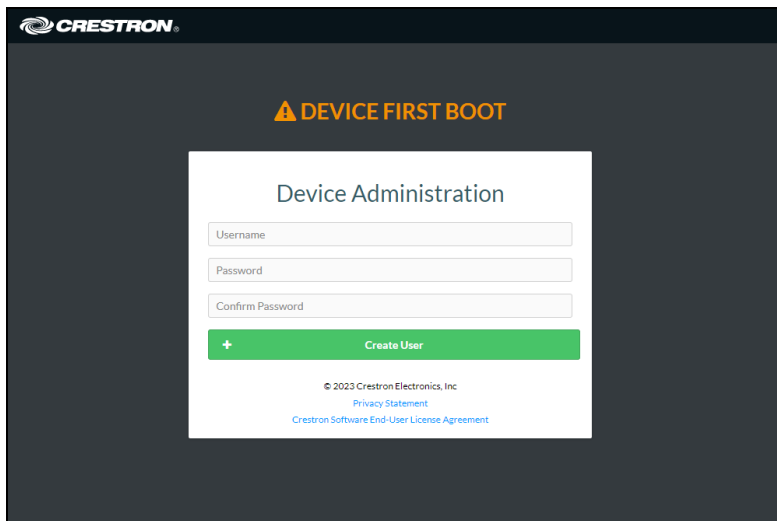
The screenshot shows the Crestron Device Administration page. At the top left is the Crestron logo. Below it is a warning icon and the text "DEVICE FIRST BOOT". The main content is a white box titled "Device Administration" containing three input fields: "Username", "Password", and "Confirm Password". Below these fields is a green button with a plus sign and the text "Create User". At the bottom of the white box, there is copyright information: "© 2023 Crestron Electronics, Inc.", a link to "Privacy Statement", and a link to "Crestron Software End-User License Agreement".

- a. In the **Username** text box, enter a username.
 - b. In the **Password** text box, enter a password using a minimum of 8 characters. The password is case sensitive.
 - c. In the **Confirm Password** text box, reenter the password for confirmation.
 - d. Select **Create User**.
The Device Administration page reopens. Continue with step 5.
5. Sign in to the device as indicated on the Device Administration page.

Device Administration Page - Sign In

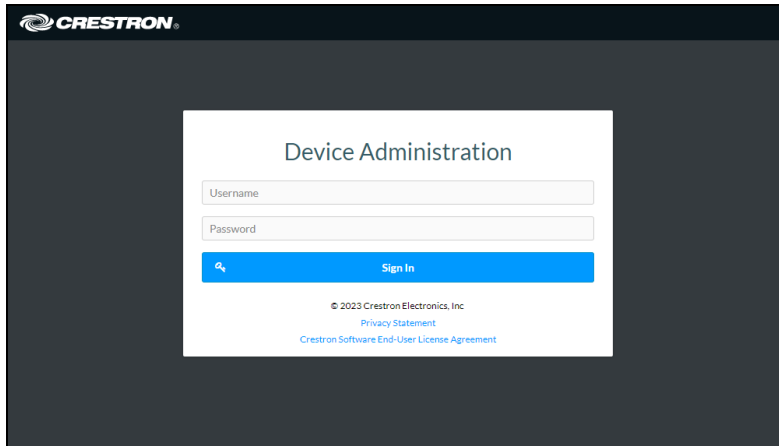

The screenshot shows the Crestron Device Administration Sign In page. At the top left is the Crestron logo. The main heading is "Device Administration". Below this are two text input fields: "Username" and "Password". A blue "Sign In" button with a magnifying glass icon is positioned below the password field. At the bottom of the form, there is copyright information: "© 2023 Crestron Electronics, Inc.", a link to "Privacy Statement", and a link to "Crestron Software End-User License Agreement".

- a. In the **Username** text box, enter the username.
- b. In the **Password** text box, enter the password. The password is case sensitive.
- c. Select **Sign In**. The web interface opens.

Navigating the Web Interface

After signing in to the web interface, the web interface appears as shown in the sample screen below.

Web Interface (Sample HD-TXU-4KZ-211 Screen Shown)

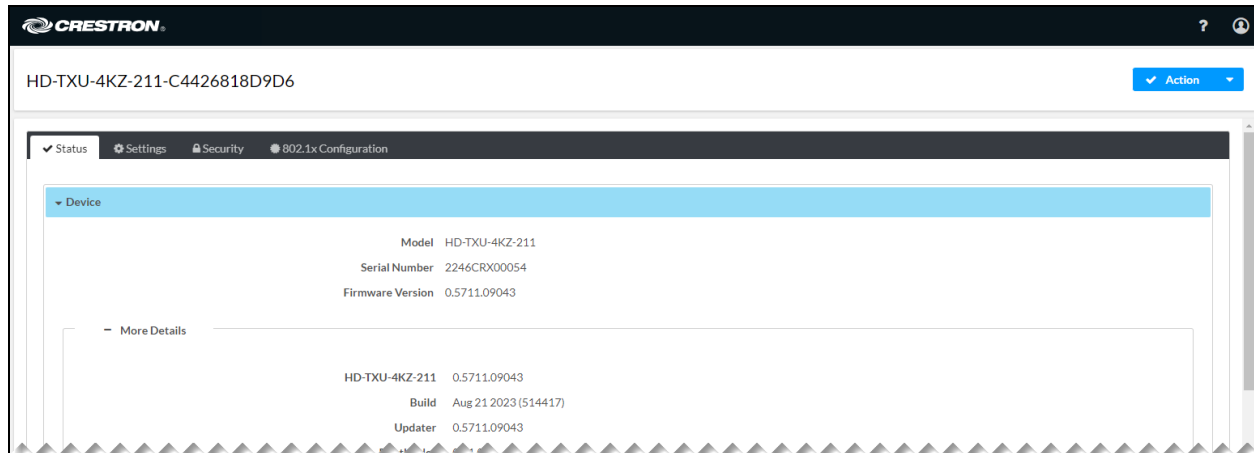

The web interface provides the following navigation tabs:

- Status (refer to [Viewing Status Information](#) for information)
- Settings (refer to [Configuring Setup and Operational Settings](#) for information)
- Security (refer to [Configuring Security Settings](#) for information)
- 802.1x Configuration (refer to [Configuring IEEE 802.1X Settings](#) for information)

In addition to the navigation tabs, an **Action** menu is provided in the upper-right corner of the web interface.

Action Menu

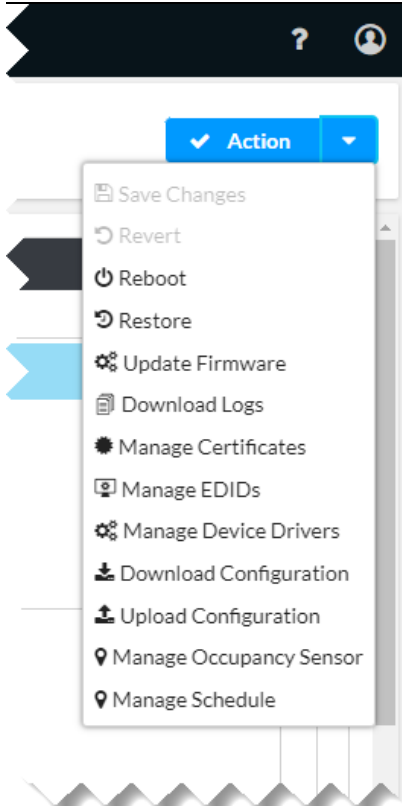

The **Action** menu enables configuration changes to be saved (refer to [Saving Configuration Changes](#) for information).

The **Action** menu also enables the following device management functions to be performed:

- [Rebooting the device](#)
- [Restoring factory default settings](#)
- [Updating firmware](#)
- [Downloading message logs](#)
- [Managing certificates](#)
- [Managing EDIDs](#)
- [Managing device drivers](#)
- [Downloading a configuration file](#)
- [Uploading a configuration file](#)
- [Managing an occupancy sensor](#)
- [Managing schedules](#)

Saving Configuration Changes

Changes to configuration settings in the **Settings**, **Security**, and **802.1x Configuration** tabs are either saved automatically or must be saved manually. Sections of the web interface in which changes are

saved automatically are enclosed by a green rectangle and include the word **Autosaved** next to the configuration section name.

Example of Configuration Changes Automatically Saved

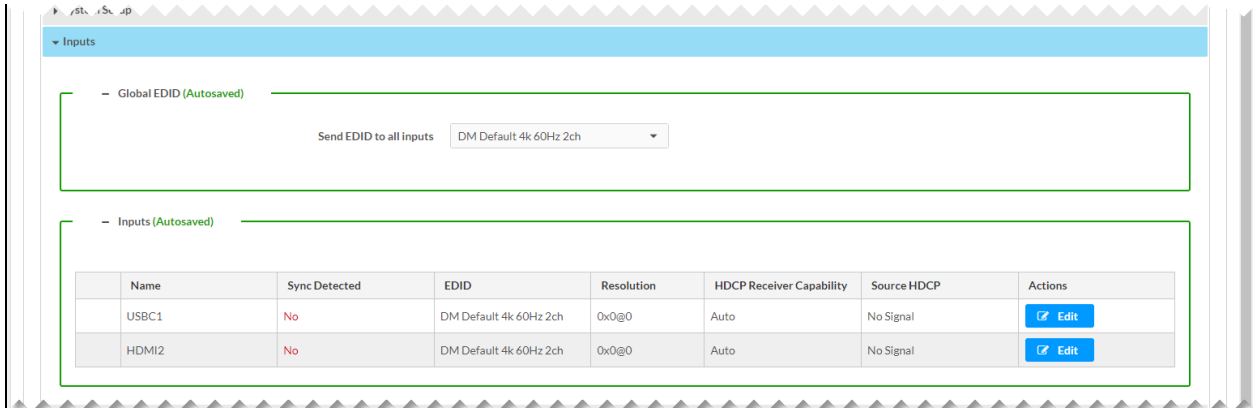

Settings that must be saved manually can be saved by using the **Action** menu of the web interface. By default, the **Action** menu provides **Save Changes** and **Revert** (undo) menu items that are disabled (grayed out) prior to configuration settings being changed.

Action Menu - Save Changes and Revert Menu Items Disabled

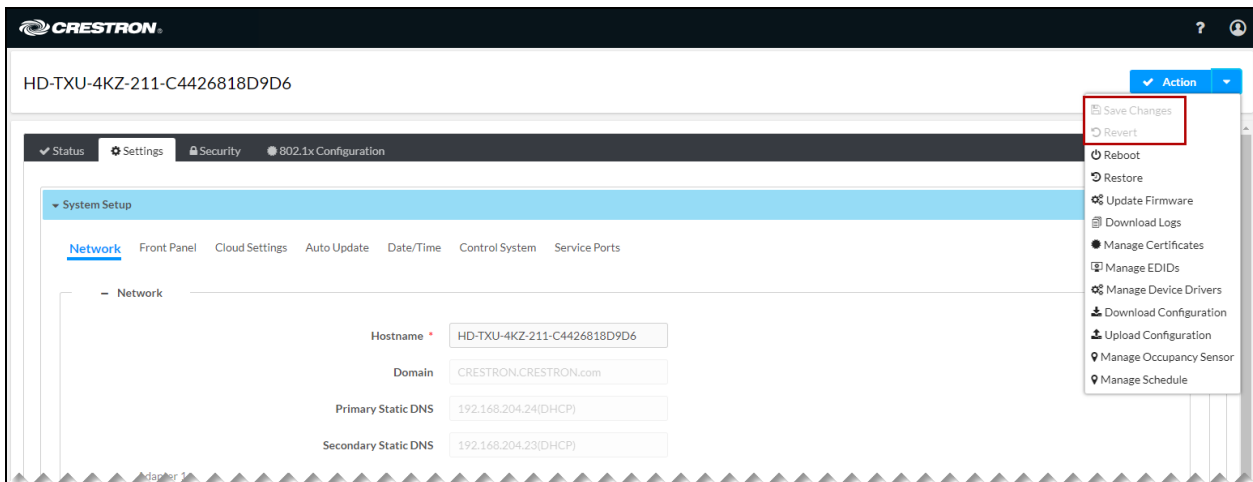

After one or more configuration settings are changed, the **Save Changes** menu item is enabled.

Action Menu - Save Changes Menu Item Enabled

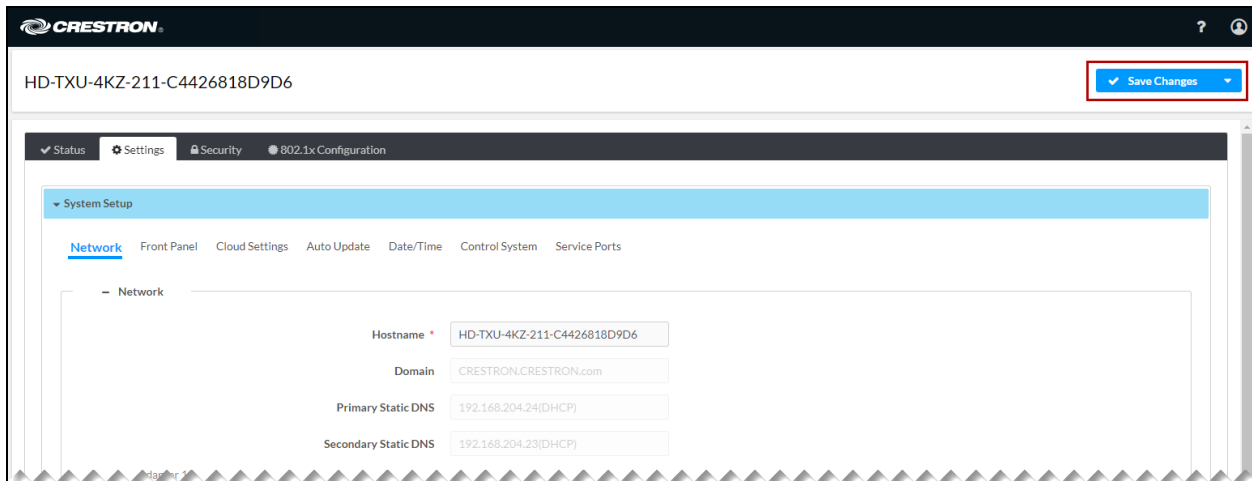

Do either of the following:

- To save one or more configuration changes, select **Save Changes**.
- To undo the newly entered configuration changes and revert to the previously saved settings, select the drop-down arrow to the right of the **Save Changes** menu item and select **Revert**.

Action Menu - Revert Menu Item Enabled

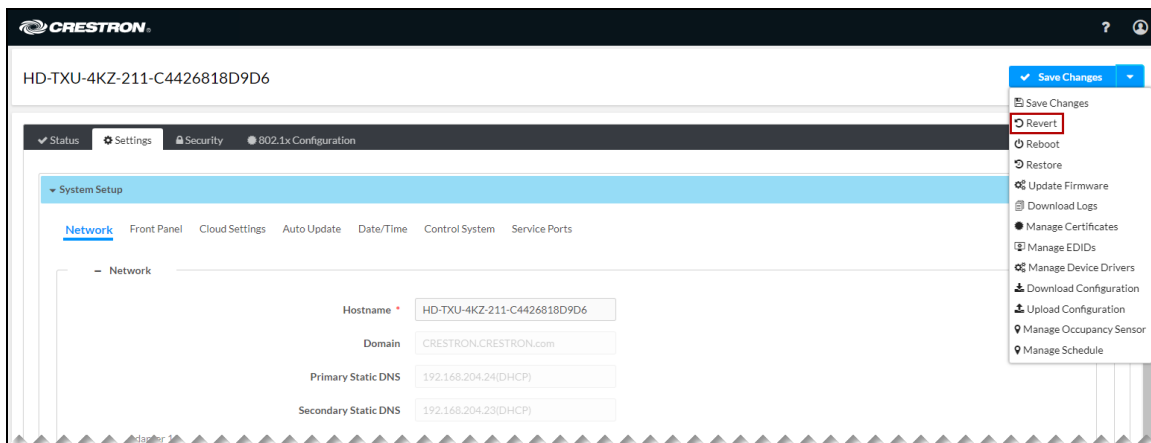

Viewing Status Information

Select the **Status** tab to view information about the DM Essentials device. By default, the **Status** tab is displayed after the web interface is accessed.

Status Tab (HD-TXU-4KZ-211 Shown)

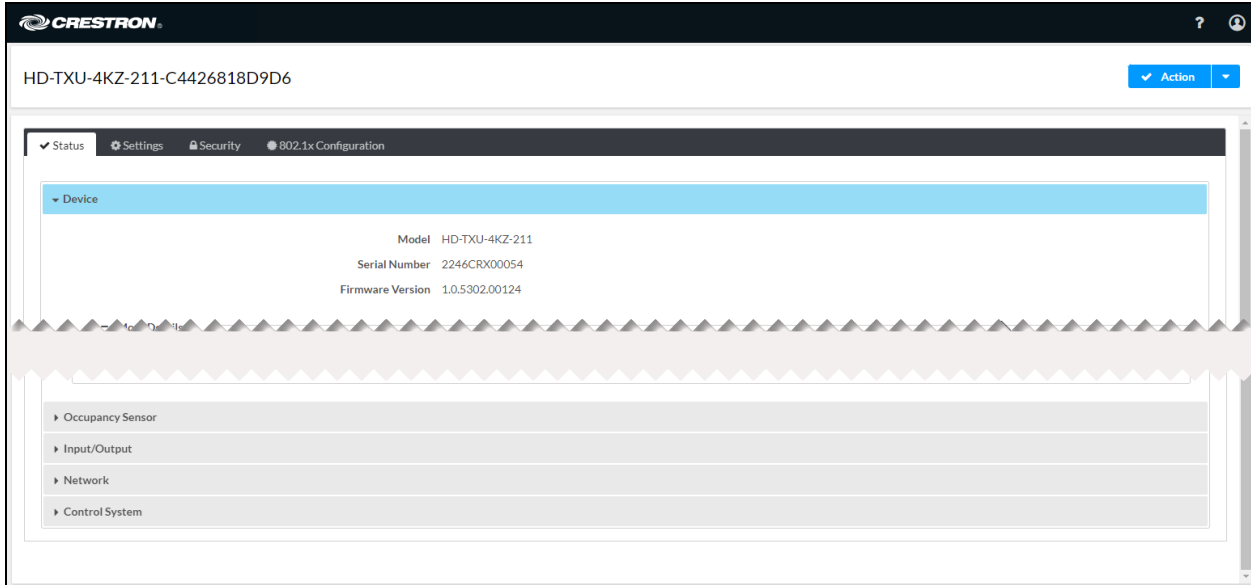

The **Status** tab consists of the following sections:

- [Device](#)
- [Occupancy Sensor](#)
- [Input/Output](#)
- [Network](#)
- [Control system](#)

To open or close any section of the **Status** tab, select the corresponding section name.

Device

By default, the **Device** section is displayed when the **Status** tab opens.

Status Tab - Device (HD-TXU-4KZ-211 Shown)

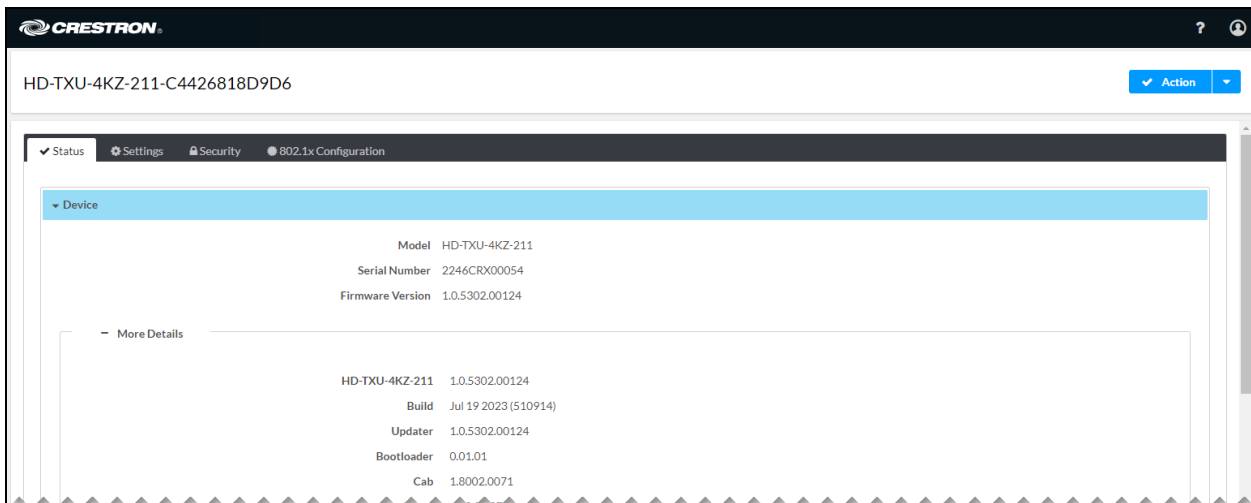

The **Device** section displays general information such as the model name, serial number, and firmware version of the device. By default, the **More Details** section is open, displaying additional information about the device. To close the section, select **More Details**.

The **Device** section also displays information about the DM Essentials connection. On an HD-TXU-4KZ-211(-CHGR) transmitter, the **Receivers** table displays information about whether the DM Essentials output port (DM OUT) of the transmitter is connected to a DM Essentials receiver.

Status Tab - Device, Receivers (HD-TXU-4KZ-211 Shown)

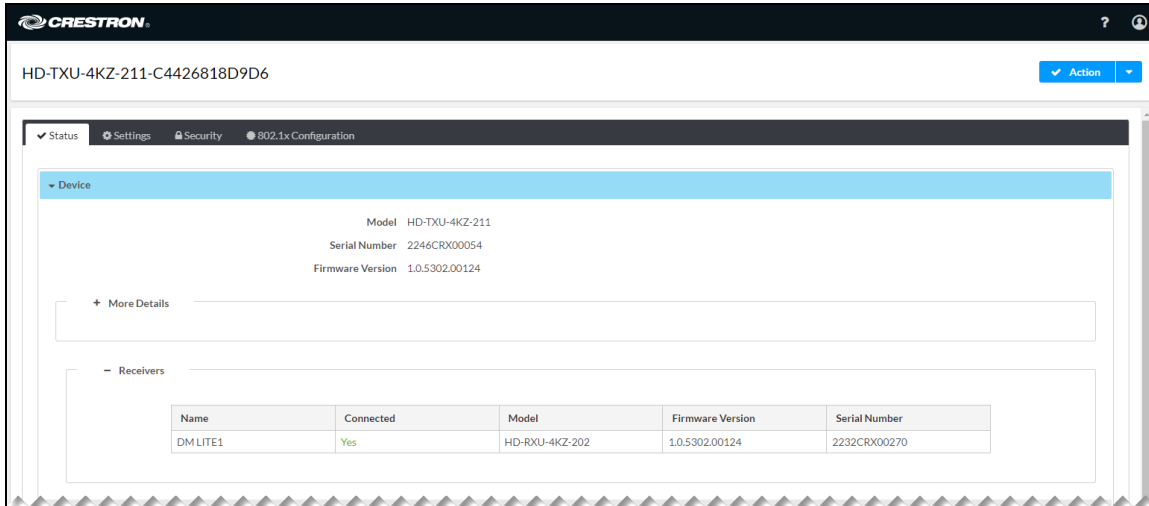

The **Receivers** table displays the following information:

- **Name:** Displays the name assigned to the **DM OUT** port on the HD-RXU-4KZ-211(-CHGR).
- **Connected:** Displays whether the port is connected to a DM Essentials receiver (**Yes** or **No**)
- **Model:** Displays the model name of the connected DM Essentials receiver (for example, **HD-RXU-4KZ-202**).
- **Firmware Version:** Displays the firmware version of the connected DM Essentials receiver
- **Serial Number:** Displays the serial number of the connected DM Essentials receiver

On the HD-TXU-RKZ-202, the **Transmitters** table displays information about whether the DM Essentials input port (DM IN 2) of the receiver is connected to a DM Essentials transmitter (HD-TXU-4KZ-211 or HD-TXU-4KZ-211-CHGR).

Status Tab - Device, Transmitters (HD-RXU-4KZ-202 Shown)

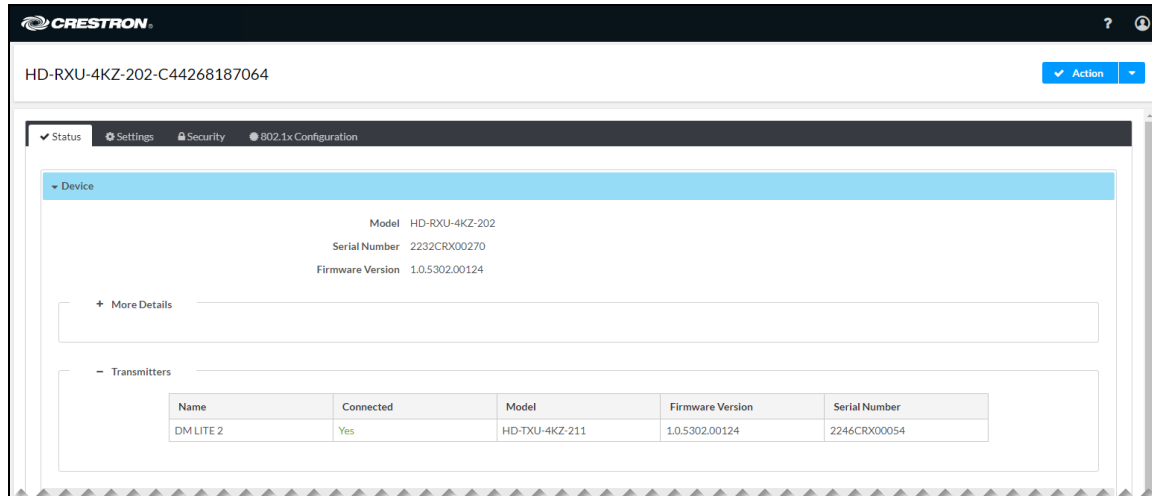

The **Transmitters** table displays the following information:

- **Name:** Displays the name assigned to the **DM IN 2** port on the HD-RXU-4KZ-202.
- **Connected:** Displays whether the port is connected to a DM Essentials transmitter (**Yes** or **No**)
- **Model:** Displays the model name of the connected DM Essentials transmitter (for example, **HD-TXU-4KZ-211**).
- **Firmware Version:** Displays the firmware version of the connected DM Essentials transmitter
- **Serial Number:** Displays the serial number of the connected DM Essentials transmitter

Occupancy Sensor

To display information related to an occupancy sensor that is accessible from the network:

Open the **Status** tab and navigate to **Occupancy Sensor**.

Status Tab - Occupancy Sensor (HD-RXU-4KZ-202 Shown)

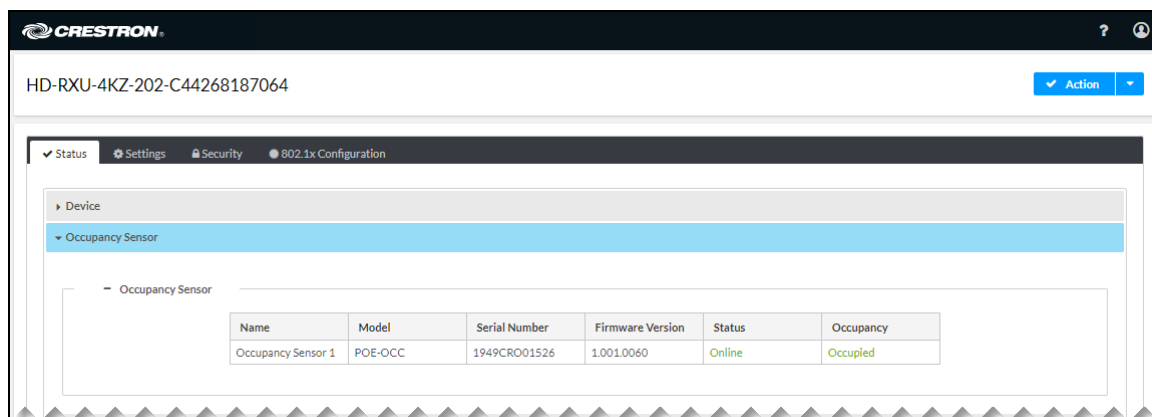

The **Occupancy Sensor** table displays the following information:

- **Name:** Displays the name assigned to the occupancy sensor.
- **Model:** Displays the model name of the occupancy sensor

- **Serial Number:** Displays the serial number of the occupancy sensor
- **Firmware Version:** Displays the firmware version of the occupancy sensor
- **Status:** Displays the status of the occupancy sensor as **Online** or **Network Timeout**
- **Occupancy:** Displays the detected occupancy status of the room as **Occupied** or **Vacant**

Input/Output

To display input and output information:

Open the **Status** tab and navigate to **Input/Output**.

Status Tab - Input/Output (HD-RXU-4KZ-202 Shown)

The screenshot shows the Crestron web interface for device HD-RXU-4KZ-202. The 'Input/Output' section is expanded, showing two tables:

Name	Sync Detected	Resolution	Source HDCP
HDMI 1	Yes	1920x1080@60	Non-HDCP
DM LITE 2	No	0x0@0	No Signal

Name	Sink Connected	Resolution	Sink HDCP Capability	Disabled by HDCP
HDMI 1	No	0x0@0	Not Connected	No
HDMI 2	No	0x0@0	Not Connected	No

The **Inputs** table displays the following input information:

- **Name:** Displays the name assigned to the input.
- **Sync Detected:** Displays whether a signal is detected at the input (**Yes** or **No**)
- **Resolution:** Displays the resolution of the input signal. If no signal is detected, **0x0@0** is displayed.
- **Source HDCP:** Displays the HDCP (High-bandwidth Digital Content Protection) level of the input signal as one of the following: **Non-HDCP**, **HDCP 1.x**, or **HDCP 2.x**). If no signal is detected, **No Signal** is displayed.

The **Outputs** table displays the following output information:

- **Name:** Displays the name assigned to the output.
- **Sink Connected:** For the HD-RXU-4KZ-202, displays whether a display device is connected to an HDMI output (**Yes** or **No**). For the HD-TXU-4KZ-211(-CHGR), displays whether the DM Essentials output is connected to a DM Essentials receiver (for example, the HD-RXU-4KZ-202).

- **Resolution:** Displays the resolution of the output signal. If no signal is detected, **0x0@0** is displayed.
- **Sink HDCP Capability:** For the HD-RXU-4KZ-202, displays the HDCP capability of the display device. For the HD-TXU-4KZ-211(-CHGR), displays the HDCP capability of the display device connected to the DM Essentials receiver. Possible values are the following: **HDCP 1.x**, **HDCP 2.x**, or **Non-HDCP**. If a display device is not connected, **Not Connected** is displayed.
- **Disabled by HDCP:** Displays whether the video output is disabled by HDCP (**Yes** or **No**). **Yes** indicates that audio will be transmitted but video will not be transmitted. **No** indicates that both audio and video will be transmitted.

NOTE: For the HD-TXU-4KZ-211, the **Resolution**, **Sink HDCP**, and **Disabled by HDCP** rows are only valid when a display is connected. If the display is disconnected, previous values may persist until the HD-TXU-4KZ-211 is rebooted.

Network

To view network-related information:

Open the **Status** tab and navigate to **Network**.

Status Tab - Network

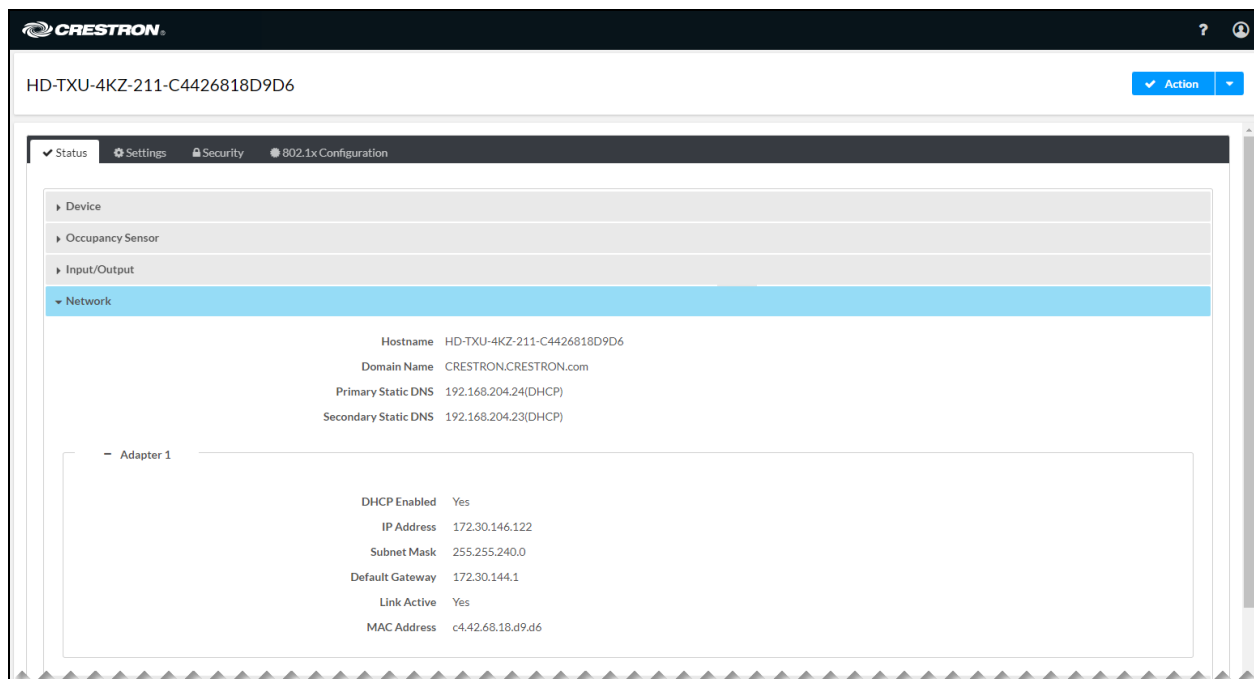

The **Network** section displays the hostname and domain name of the device. Primary and secondary static DNS IP addresses are also displayed.

By default, the **Adapter 1** section is open, displaying additional details about the network.

Control System

To view control system information:

Open the **Status** tab and navigate to **Control System**.

Status Tab - Control System

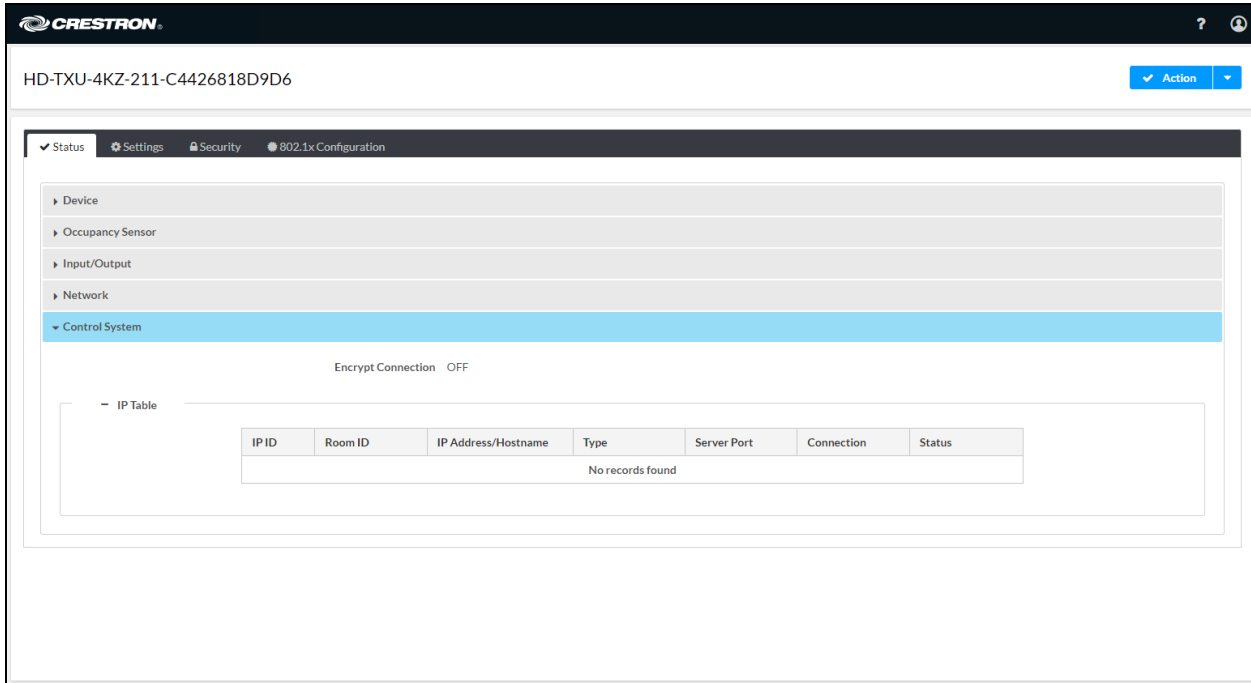

The **Control System** section displays information about whether the connection to the control system is encrypted (**ON** or **OFF**) and information about the IP table.

Configuring Setup and Operational Settings

Select the **Settings** tab to configure setup and operational settings.

Settings Tab (HD-TXU-4KZ-211 Shown)

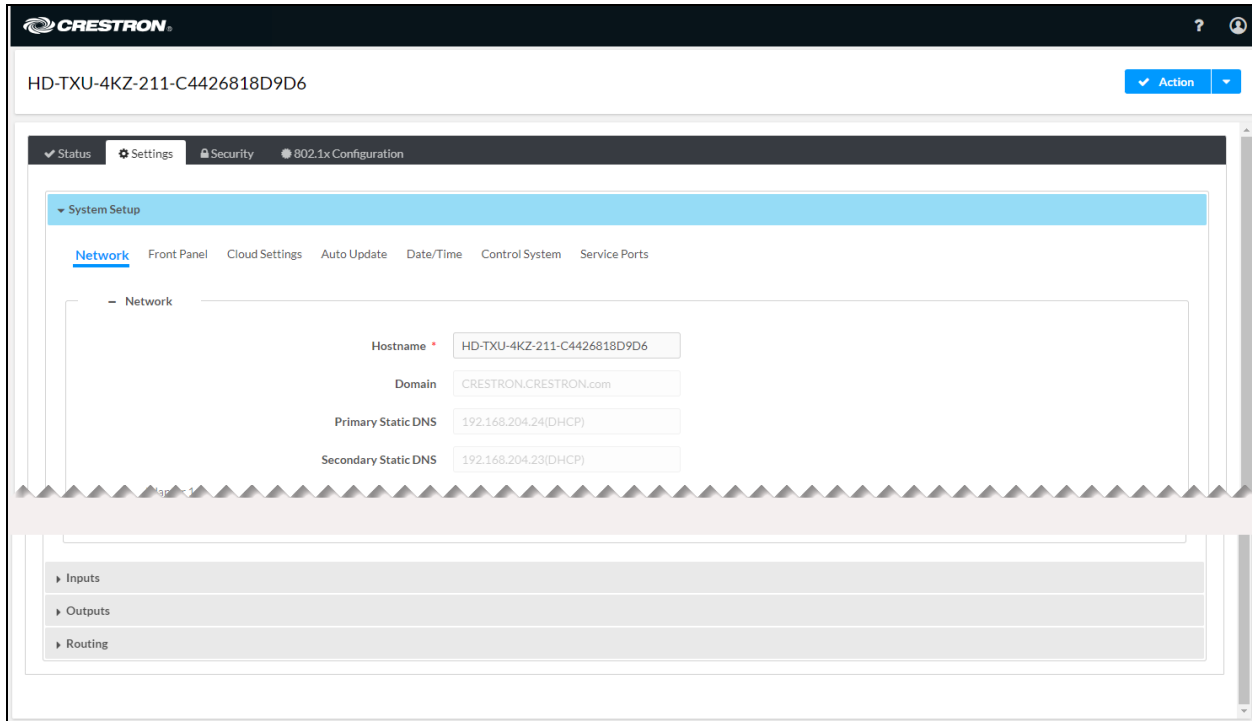

The **Settings** tab consists of the following sections:

- [System setup](#)
- [Inputs](#)
- [Outputs](#)
- [Routing](#)

To open or close any section of the **Settings** tab, select the corresponding section name.

System Setup

By default, the **System Setup** section is displayed when the **Settings** tab opens.

Settings Tab - System Setup (HD-TXU-4KZ-211 Shown)

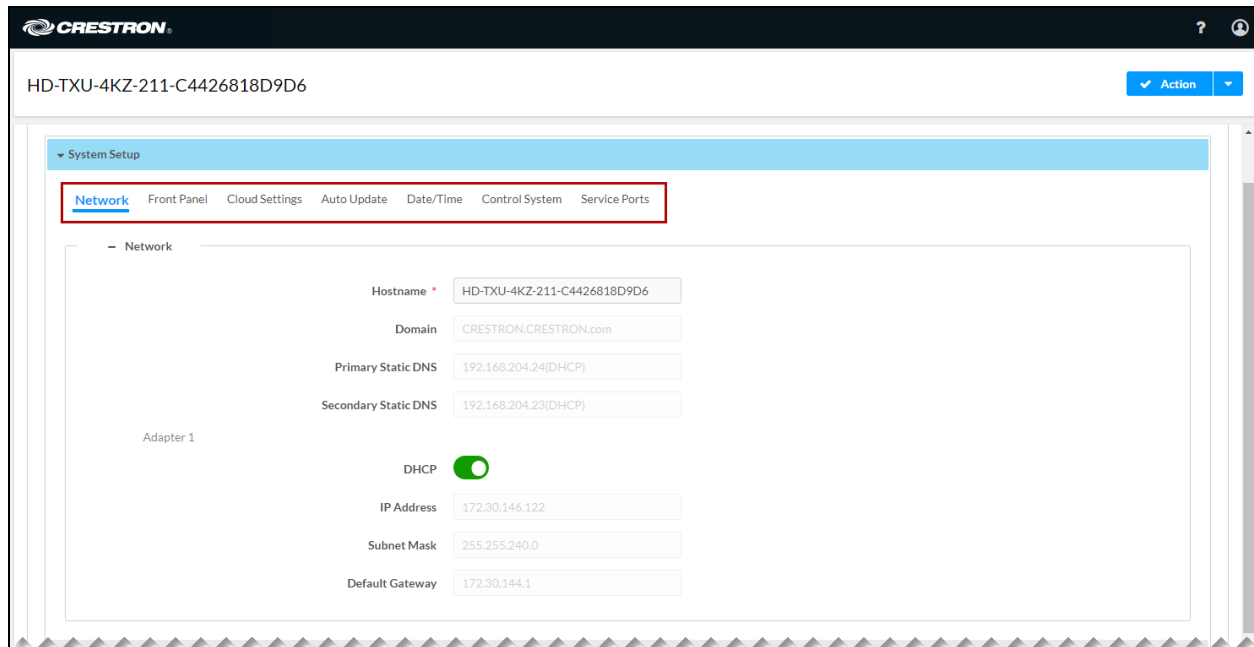

System Setup consists of the following sections:

- [Network](#)
- [Front panel](#)
- [Cloud settings](#)
- [Auto update](#)
- [Date/time](#)
- [Control system](#)
- [Service ports](#)

To open or close any section of the **Settings** tab, select the corresponding section name.

Network

To configure network settings:

Open the **Settings** tab and navigate to **System Setup > Network**. By default, the **Network** section is displayed when the **System Setup** section opens.

Settings Tab - System Setup, Network

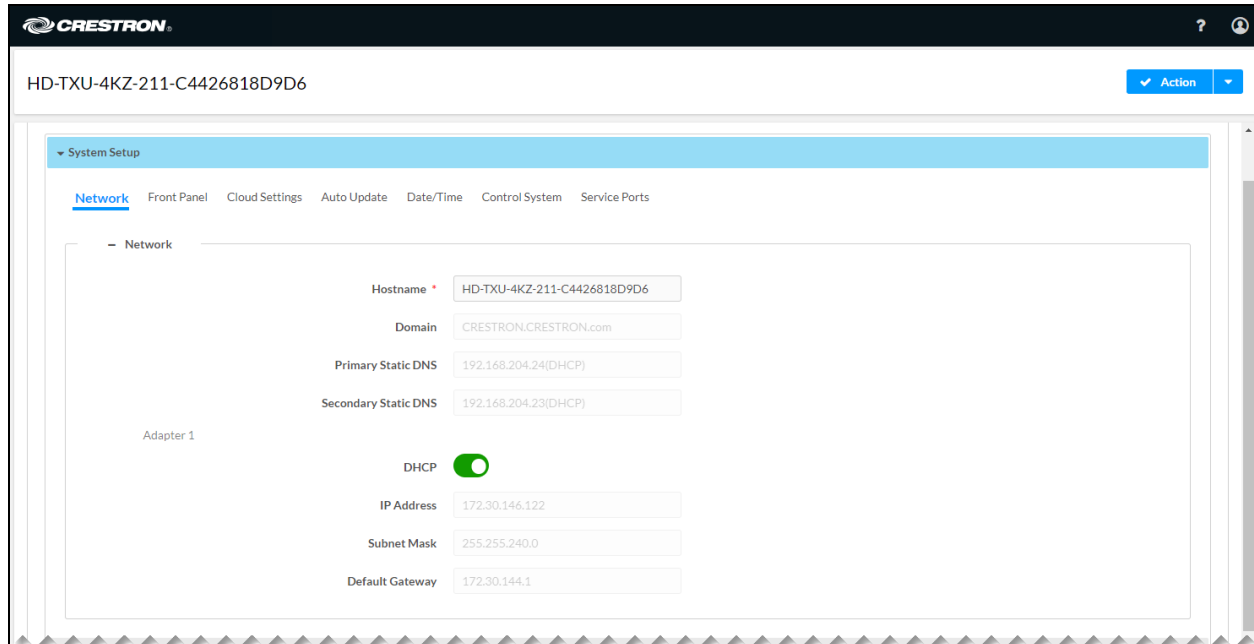

Refer to the configuration guidelines that follow.

- **Hostname:** Specifies the hostname that identifies the DM Essentials device on the network. The hostname is restricted to the letters **a** to **z** (not case sensitive), the digits **0** to **9**, and the hyphen.
The default hostname consists of the model name followed by a hyphen and the MAC address of the device. For example, if the model name is HD-TXU-4KZ-211 and the MAC address is c4.42.68.18.d9.d6, the default hostname is **HD-TXU-4KZ-211-C4426818D9D6**.
- **Domain:** (Activated when **DHCP** is disabled) Specifies the domain name for the web interface of the DM Essentials device.
- **Primary Static DNS:** (Activated when **DHCP** is disabled) Specifies the IP address of the primary static DNS (domain name system) server.
- **Secondary Static DNS:** (Activated when **DHCP** is disabled) Specifies the IP address of the secondary static DNS server.
- For **Adapter 1**, enable or disable **DHCP**. By default, DHCP is enabled (the toggle switch is set in the On position). The IP address of the DM Essentials device is assigned by a DHCP server on the network for a predetermined period of time.
To disable DHCP, set the toggle switch in the Off position.
If DHCP is disabled, enter the following:
 - **IP Address:** Specifies a unique static IP address for the DM Essentials device.
 - **Subnet Mask:** Specifies the subnet mask that is set on the network.
 - **Default Gateway:** Enter the IP address that is to be used as the default gateway.

Front Panel

To configure front panel settings:

Open the **Settings** tab and navigate to **System Setup > Front Panel**.

Settings Tab - System Setup, Front Panel

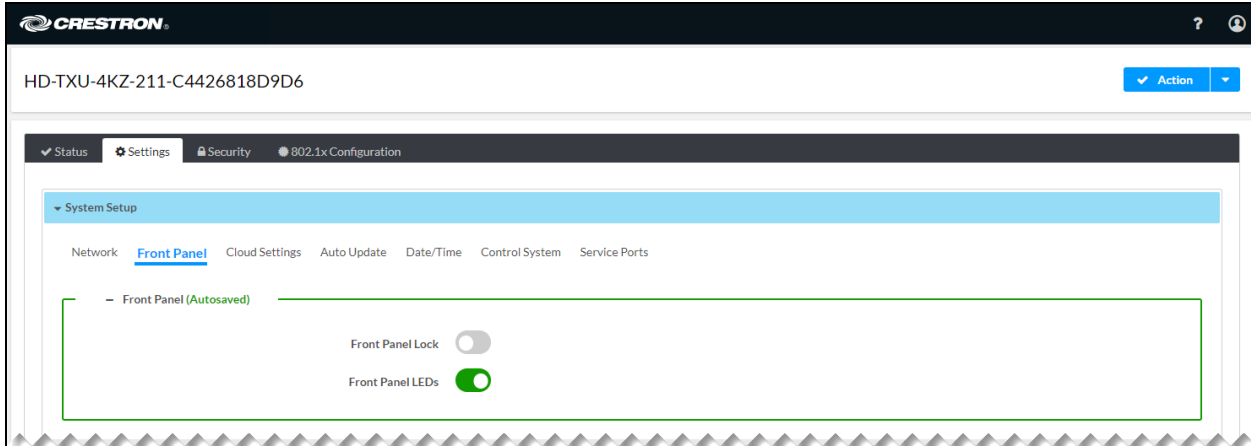

Refer to the configuration guidelines that follow.

- **Front Panel Lock:** Unlocks or locks front panel push buttons excluding the **SETUP** push button. By default, **Front Panel Lock** is disabled (the toggle switch is set in the Off position), enabling the push buttons to be unlocked and functional. To lock the push buttons and prevent them from being functional, set the toggle switch in the On position.
- **Front Panel LEDs:** Enables or disables front panel LEDs excluding the **SETUP** LED. By default, **Front Panel LEDs** is enabled (the toggle switch is set in the On position), allowing the LEDs to light as appropriate. To disable the LEDs and prevent them from lighting, set the toggle switch in the Off position.

NOTE: Although front panel push buttons may be locked and LEDs may be disabled, the device continues to function.

Cloud Settings

To enable or disable connection of the DM Essentials device to the XiO Cloud® service:

Open the **Settings** tab and navigate to **System Setup > Cloud Settings**.

Settings Tab - System Setup, Cloud Settings

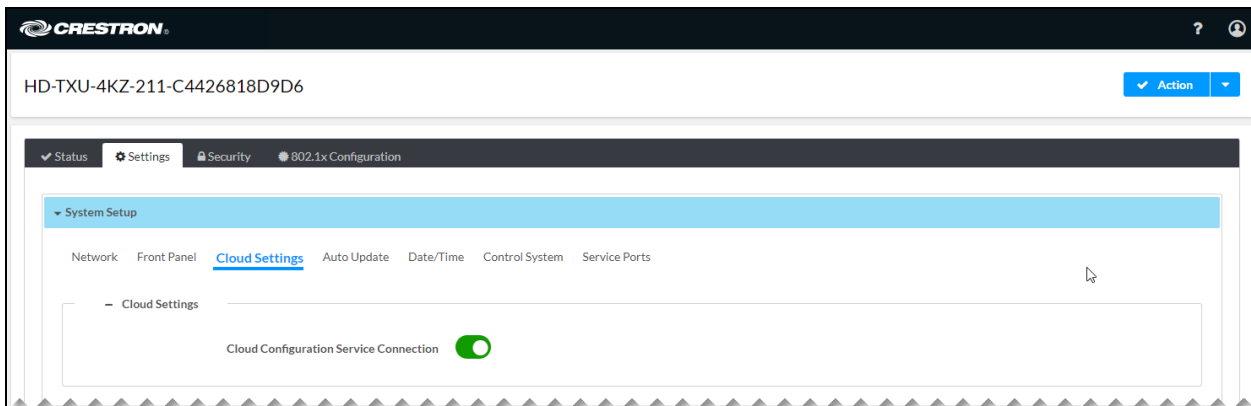

By default, the **Cloud Configuration Service Connection** toggle switch is in the On position, enabling connection to the XiO Cloud service. To disable the connection, set the toggle switch in the Off position.

NOTE: For information about the XiO Cloud service, refer to the [XiO Cloud Provisioning and Management Service User Guide](#).

Auto Update

The DM Essentials device can be configured to be updated automatically with the latest firmware at scheduled intervals.

NOTE: Before configuring automatic firmware update using the web interface, use the Crestron Auto Update tool to generate a manifest file (*.mft). The file is placed on an FTP or SFTP server and will be used in the automatic firmware update process.

To configure automatic firmware updates:

Open the **Settings** tab and navigate to **System Setup > Auto Update**.

Settings Tab - System Setup, Auto Update

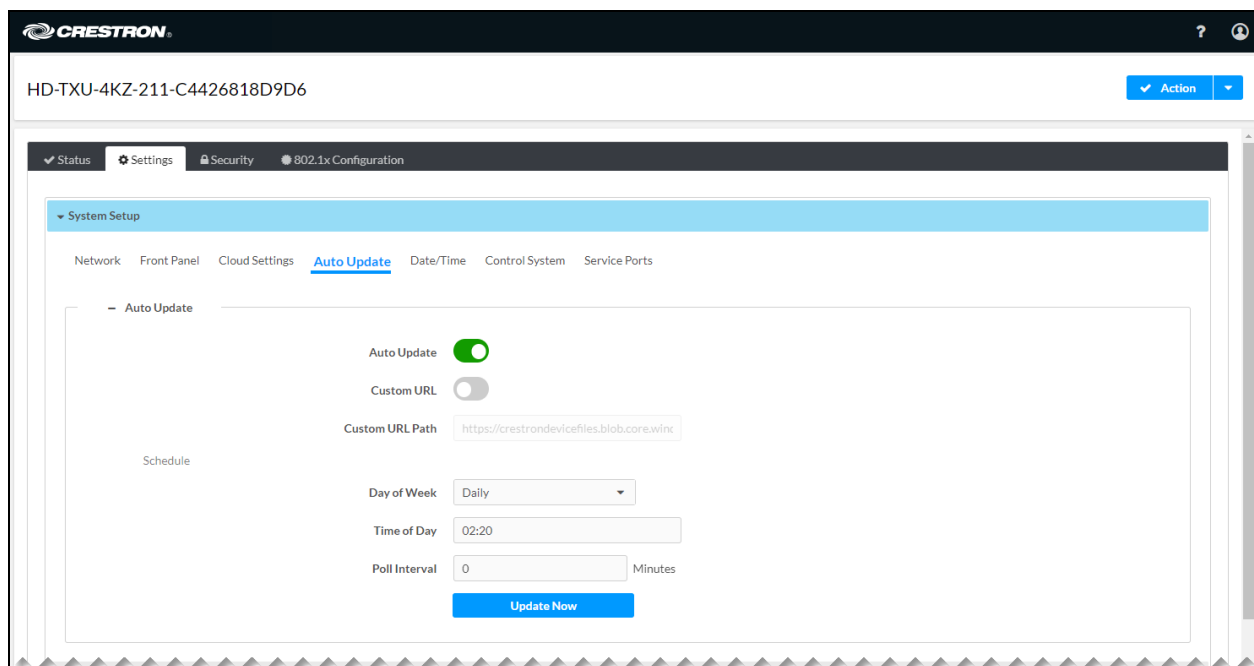

Refer to the configuration guidelines that follow.

- **Auto Update:** By default, **Auto Update** is enabled (the toggle switch is set in the On position). When enabled, automatic firmware update can be configured. To disable automatic firmware update, set the **Auto Update** toggle switch in the Off position.
- **Custom URL:** (Activated when **Auto Update** is enabled) By default, **Custom URL** is disabled (the toggle switch is set in the Off position). When disabled, the server URL defaults to the standard Crestron update server from which the latest firmware file is to be downloaded to the DM Essentials device.

To enable entry of a custom update server URL path to the manifest file, set the toggle switch in the On position.

- **Custom URL Path:** (Activated when **Custom URL** is enabled) Enter the path to the manifest file in the following FTP or SFTP URL format:

ftp://username:password@host:port/path/filename

or

sftp://username:password@host:port/path/filename

where:

- *username* is the username on the FTP or SFTP server
- *password* is the password for the username
- *host* is the fully qualified domain name or IP address of the FTP or SFTP server
- *port* is the connection port on the host

NOTE: The default FTP port number is 21. The default SFTP port number is 22. Entry of a port number is necessary only if the port number differs from the default value of 21 or 22.

- *path* is the path to the manifest file
- *filename* consists of the name and extension (.mft) of the manifest file

In the **Schedule** section, set a schedule for automatic firmware updates by doing either of the following:

- Select the desired day and time:
 - **Day of Week:** In the drop-down list, select one of the following: **None, Daily, Sunday, Monday, Tuesday, Wednesday, Thursday, Friday,** or **Saturday**. The default setting is **Daily**.
 - **Time of Day:** In the pop-up scroll box, select the desired time of day in 24-hour format.
- Set the Poll Interval at which the DM Essentials device will poll the server for a firmware update. Enter a value from 60 to 65535 minutes. The default setting is 0, which disables the poll interval.

If a later firmware version is available, selecting **Update Now** causes the firmware to be updated at the current time; however, the schedule that is set in the **Schedule** section remains in effect.

Date/Time

To configure date and time settings for the DM Essentials device:

Open the **Settings** tab and navigate to **System Setup > Date/Time**.

Settings Tab - System Setup, Date/Time

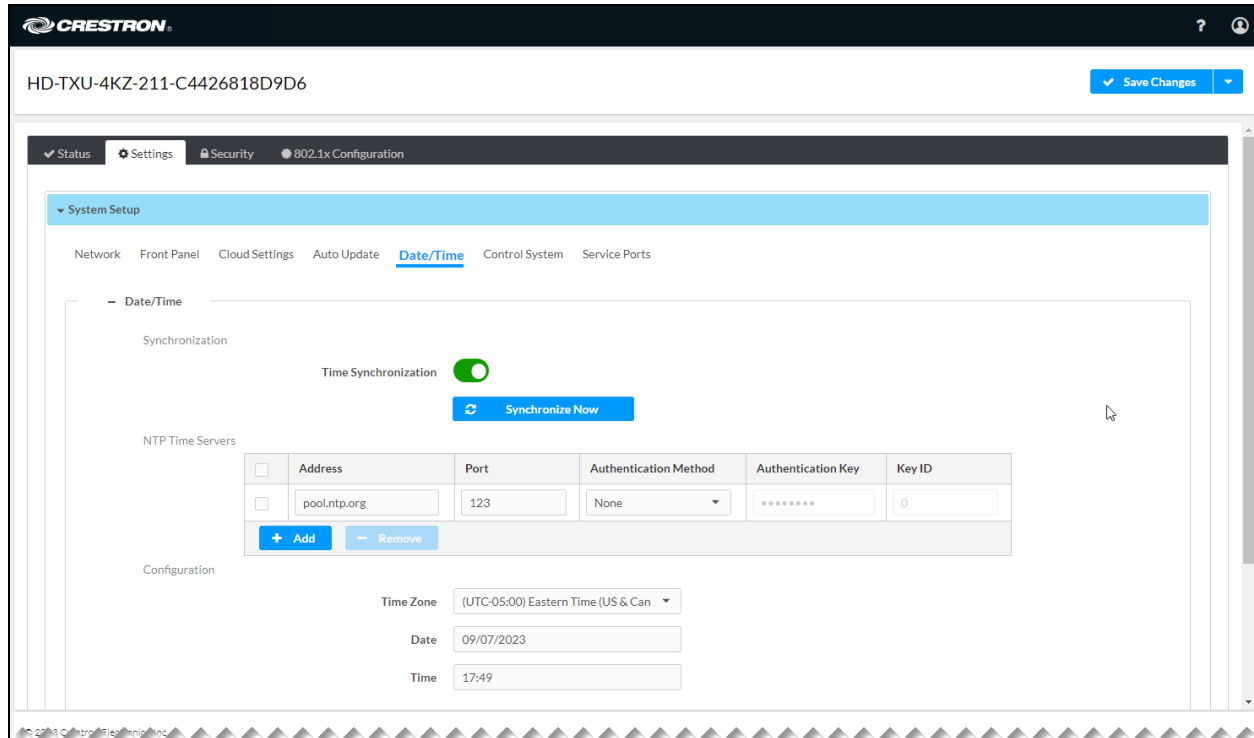

Refer to the configuration guidelines that follow.

- In the **Synchronization** section, enable or disable **Time Synchronization**. By default, **Time Synchronization** of the DM Essentials device with NTP (Network Time Protocol) servers is enabled (the toggle switch is set in the On position). To disable time and date synchronization, set the **Time Synchronization** toggle switch in the Off position.

If **Time Synchronization** is enabled, select the **Synchronize Now** button after entering one or more NTP servers in the **NTP Time Servers** table as discussed below.

- (Applicable only when **Time Synchronization** is enabled) In the **NTP Time Servers** table, assign NTP servers as required. The default NTP server is **pool.ntp.org** with a port number of **123** and no authentication method (**None**). The default NTP server can be changed or deleted if desired as discussed below.

To add additional servers, select the **Add** button. Up to three NTP servers are supported: one primary server and two secondary servers.

For each NTP server that is added, assign the following settings:

- **Address:** Enter the IP address or hostname of the NTP server. The default NTP server address of **pool.ntp.org** can be used or changed if desired.
- **Port:** In the text box, enter the port number of the NTP server. The default NTP server, **pool.ntp.org**, is assigned port **123**, which can be used or changed if desired.
- **Authentication Method:** In the drop-down list, select **None**, **SHA1**, or **SHA256**. The setting of **SHA1** or **SHA256** provides secure NTP MAC authentication. The default NTP server, **pool.ntp.org**, is assigned **None**, which can be used or changed if desired.
- **Authentication Key:** (Activated when **SHA1** or **SHA256** is assigned as the authentication method) Enter the pre-shared key between the DM Essentials device (NTP client) and the NTP server.
- **Key ID:** (Activated when **SHA1** or **SHA256** is assigned as the authentication method) Enter the pre-shared key index between the DM Essentials device (NTP client) and the NTP server. Valid values range from **1** to **65535**

To delete an NTP server, select the corresponding checkbox and then select the **Remove** button. To select and delete all NTP servers simultaneously, select the checkbox in the topmost row of the first column and then select the **Remove** button.

- In the **Configuration** section, set the following for the DM Essentials device:
 - **Time Zone:** In the drop-down list, select the applicable time zone. The default setting is **(UTC - 05:00) Eastern Time (US & Canada)**.
 - **Date:** In the **Date** pop-up dialog box, select the current month, year, and day.
 - **Time:** In the **Time** pop-up scroll box, enter the current time in 24-hour format.

Control System

To configure control system settings:

Open the **Settings** tab and navigate to **System Setup > Control System**.

Settings Tab - System Setup, Control System

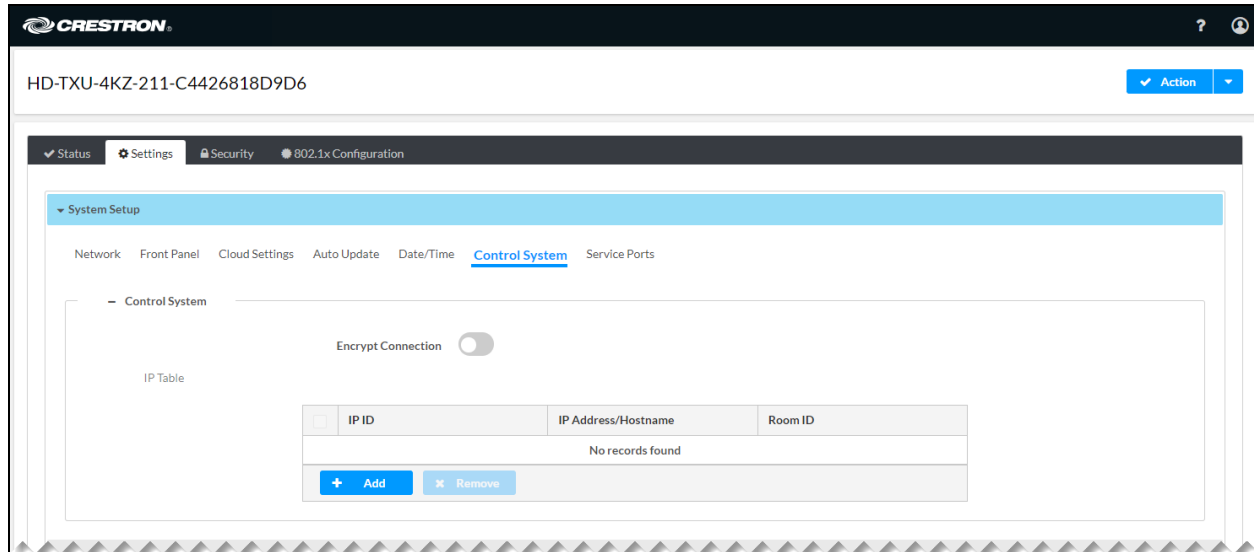

Refer to the configuration guidelines that follow.

- **Encrypt Connection:** By default, **Encrypt Connection** is disabled (the toggle switch is in the Off position). To enable an encrypted connection between the control system and the DM Essentials device, set the toggle switch in the On position.
- **Control System Username:** (Activated when **Encrypt Connection** is enabled) Enter a username that is to be used to sign in to the control system.
- **Control System Password:** (Activated when **Encrypt Connection** is enabled) Enter a password that is to be used to sign in to the control system.

In the **IP Table**, add up to 16 control systems by doing the following:

1. Select the **Add** button.
2. Assign the following settings:
 - **IP ID:** Enter the IP ID of the DM Essentials device. Valid values range from **03** to **FE** in hexadecimal notation.
 - **IP Address/Hostname:** Enter the IP address or hostname of the control system.
 - **Room ID:** (Optional) Enter the room ID.

Status indicates whether the control system is **ONLINE** or **OFFLINE**.

To delete a control system, select the corresponding checkbox and then select the **Remove** button. To select and delete all control systems, select the topmost checkbox in the first column of the table and then select the **Remove** button.

Service Ports

The front panel of the DM Essentials device includes a USB 2.0 service port, which can be used for firmware loading and configuration management. The port can also provide up to 5V 500 mA power to a USB powered device.

To enable or disable the service port:

Open the **Settings** tab and navigate to **System Setup > Service Ports**.

Settings Tab - System Setup, Service Ports

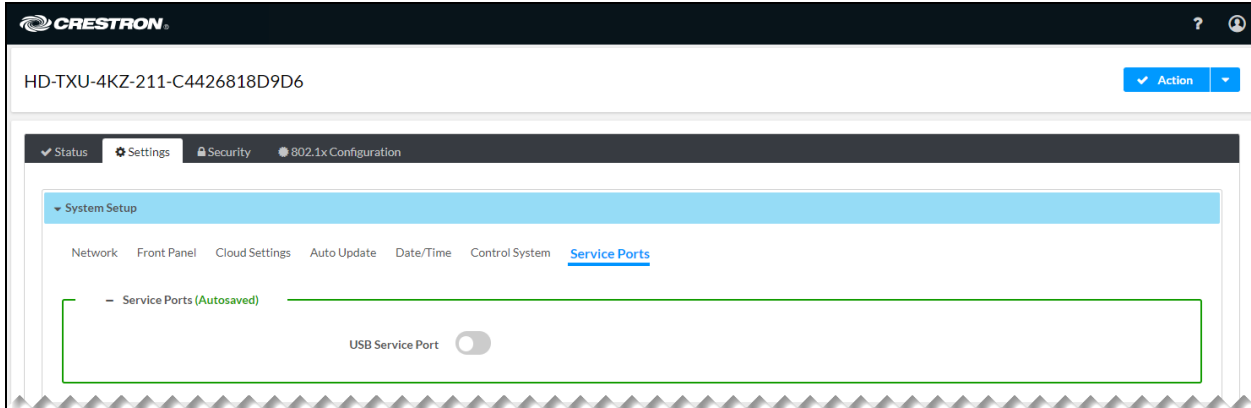

By default, **USB Service Port** is disabled (the toggle switch is in the Off position). To enable the port, set the toggle switch in the On position.

Inputs

To view information about the inputs on the DM Essentials device or to configure the inputs:

Open the **Settings** tab and navigate to **Inputs**.

Settings Tab - Inputs (HD-TXU-4KZ-211 Shown)

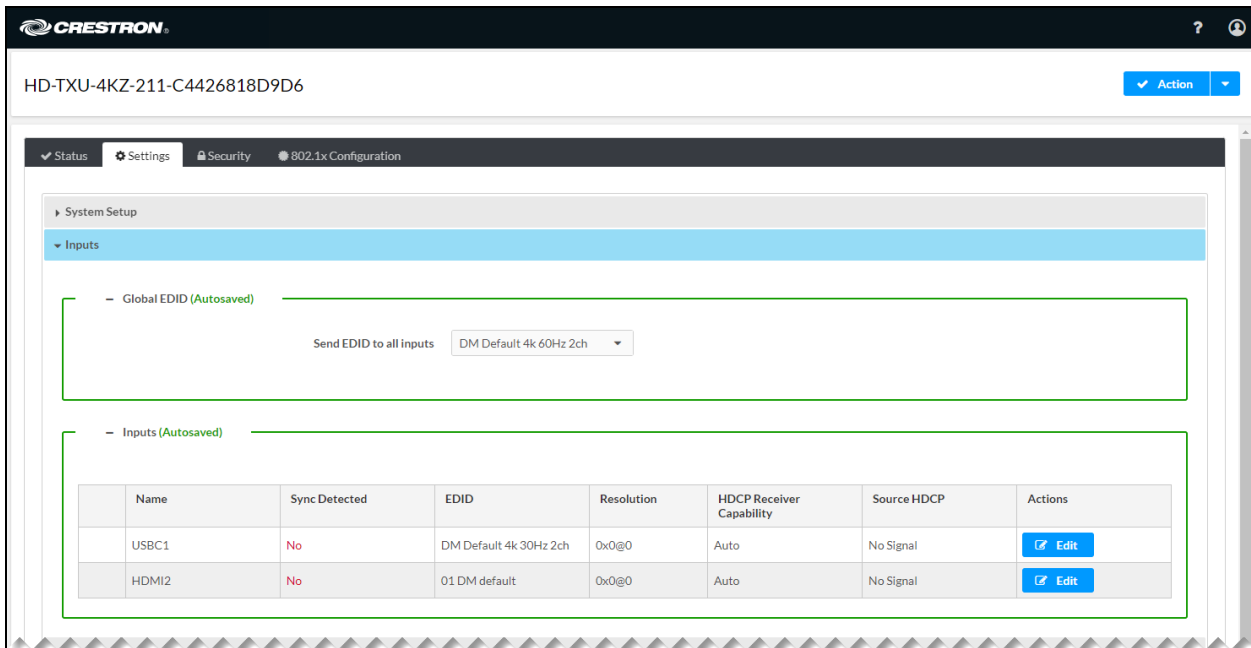

Settings Tab - Inputs (HD-RXU-4KZ-202 Shown)

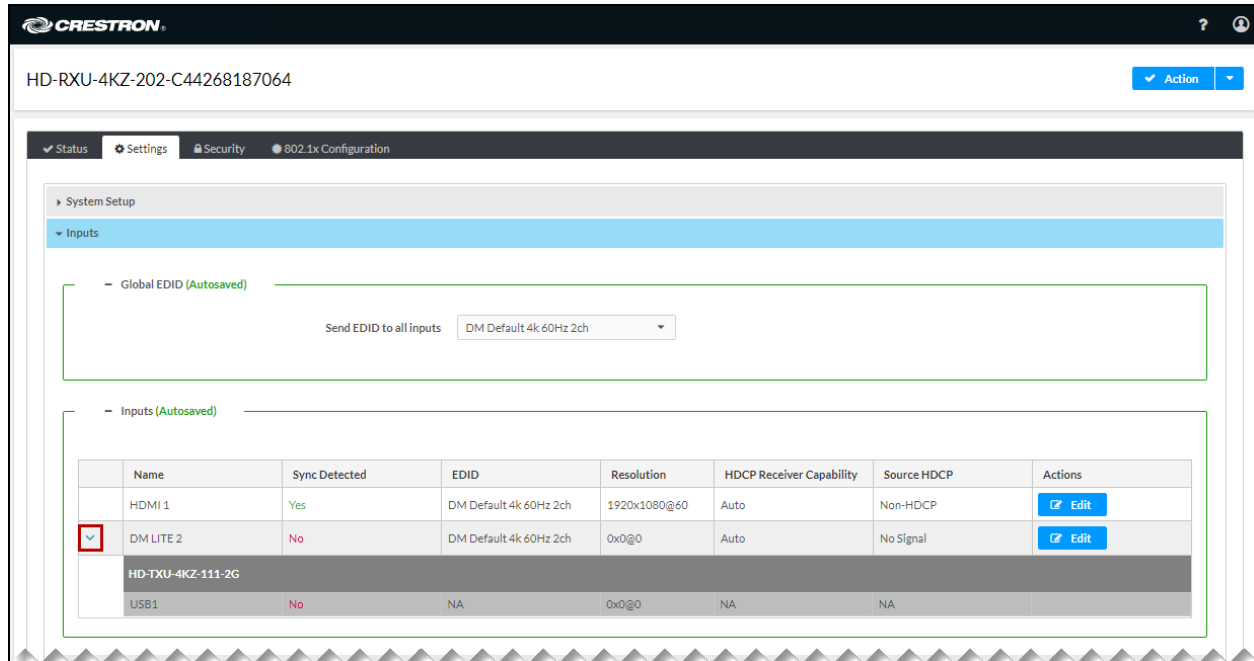

Inputs consists of the following sections:

- [Global EDID](#)
- [Inputs](#)

Global EDID

In the **Global EDID** drop-down list, the same EDID (Extended Display Identification Data) can be selected for all inputs if desired. The default setting is **DM Default 4k 60Hz 2ch**.

NOTES:

- If the desired EDID does not appear in the **Global EDID** drop-down list, refer to [Managing EDIDs](#) to add the EDID to the list.
- To select an EDID for each input on an individual basis, refer to information about the **Edit Input** pop-up dialog box in the [Inputs](#) section.

Inputs

The **Inputs** table displays the following information:

- **Name:** Indicates the name assigned to the input.

NOTE: On an HD-RXU-4KZ-202, selecting the arrowhead to the left of the DM Essentials input name displays the HD-TXU-4KZ Series transmitter to which the HD-RXU-4KZ-202 is connected.

- **Sync Detected:** Indicates whether an input signal is detected by the input (**Yes** or **No**).

- **EDID:** Indicates the EDID that is to be sent to the upstream device connected to the input.
- **Resolution:** Indicates the current resolution of the input. If **0x0@0** is displayed, no video signal is being transmitted.
- **HDCP Receiver Capability:** Indicates one of the following: **Disabled**, **Auto**, **HDCP 1.4**, or **HDCP 2.2**.
- **Source HDCP:** Indicates one of the following, based on the HDCP of the source: **HDCP 1.x**, **HDCP 2.x**, **Non-HDCP**, or **Inactive**.

To edit input settings or to view additional input status information, select the **Edit** button in the **Actions** column of the table. The **Edit Input** pop-up dialog box opens.

Edit Input Pop-Up Dialog Box

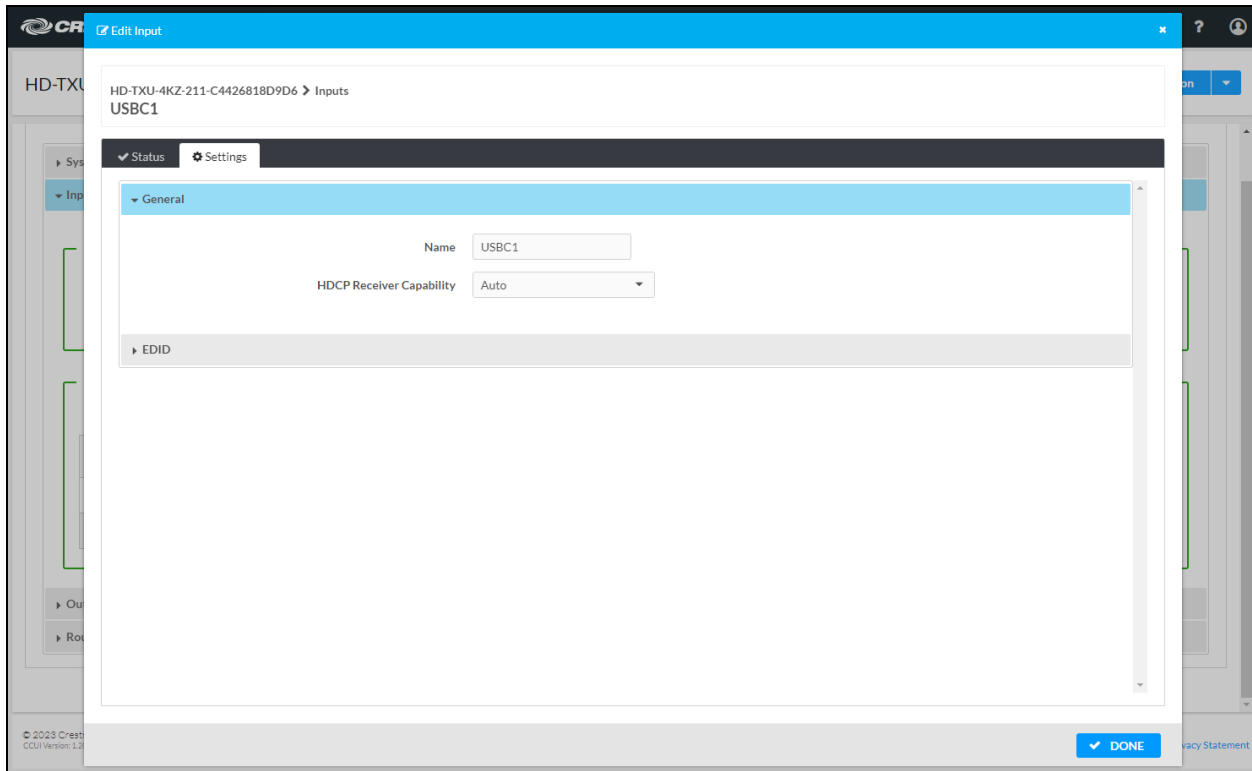

The **Edit Input** pop-up dialog box provides the following tabs:

- Settings (refer to [Editing Input Settings](#) for information).
- Status (refer to [Viewing Input Status](#) for information).

Editing Input Settings

By default, the **Settings** tab of the **Edit Input** pop-up dialog box is displayed when the dialog box opens.

Edit Input Pop-Up Dialog Box - Settings Tab

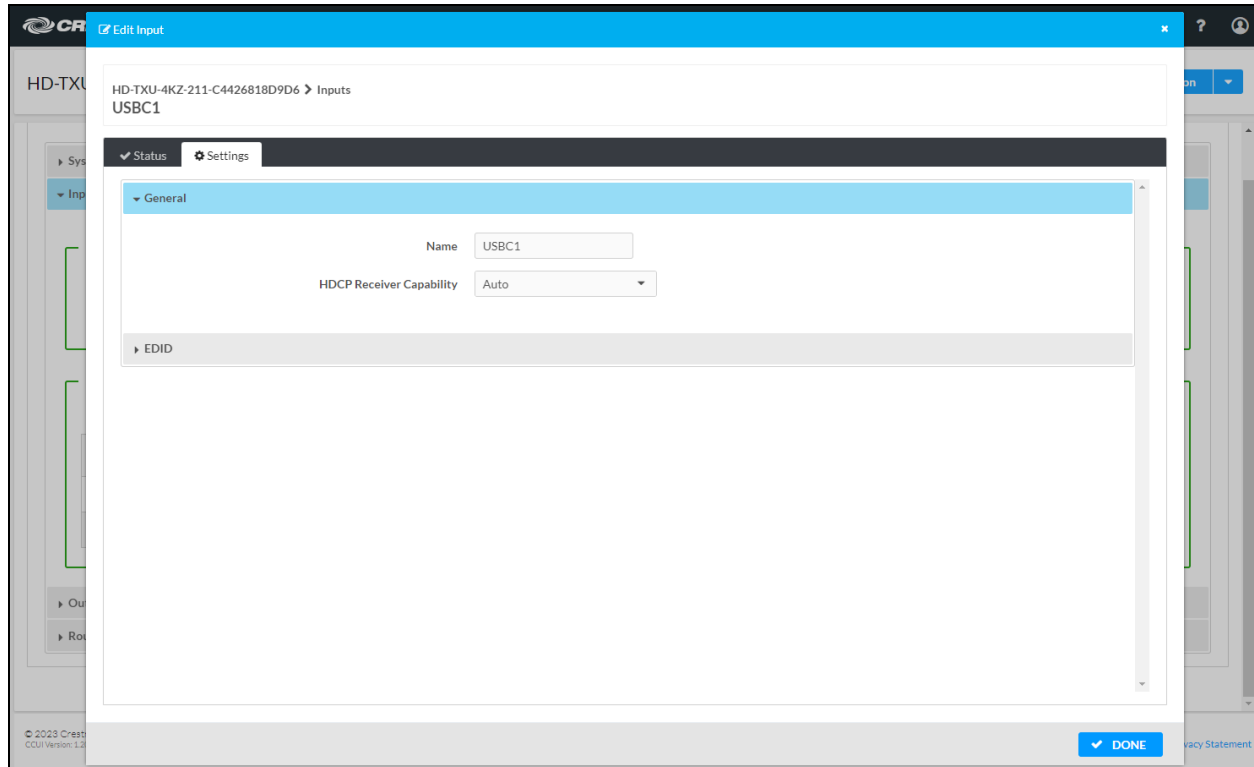

The **Settings** tab of the **Edit Input** pop-up dialog box provides the following sections:

- [General](#)
- [EDID](#)

General

In the **General** section, edit the following input settings as required:

- **Name:** Enter the desired name of the input.
- **HDCP Receiver Capability:** Select one of the following to control HDCP (High-Bandwidth Digital Content Protection) support for an input:
 - **Disabled:** Disables HDCP, causing the input to transmit non-HDCP content only.
 - **Auto:** (Default setting) Enables the input to transmit content based on the highest HDCP level of the connected source.
 - **HDCP 1.4:** Sets the HDCP level to 1.4 for HDCP content transmission by the input.
 - **HDCP 2.x:** Sets the HDCP level to 2.2 or 2.3 for HDCP content transmission by the input.

EDID

In the **EDID** section, select the desired EDID for the input.

NOTE: If the desired EDID does not appear in the **Select** drop-down list, refer to [Managing EDIDs](#) to add the EDID to the list.

Viewing Input Status

In the **Edit Input** pop-up dialog box, select the **Status** tab of to view additional information about the input signal.

Edit Input Pop-Up Dialog Box - Status Tab (HD-TXU-4KZ-211 Shown)

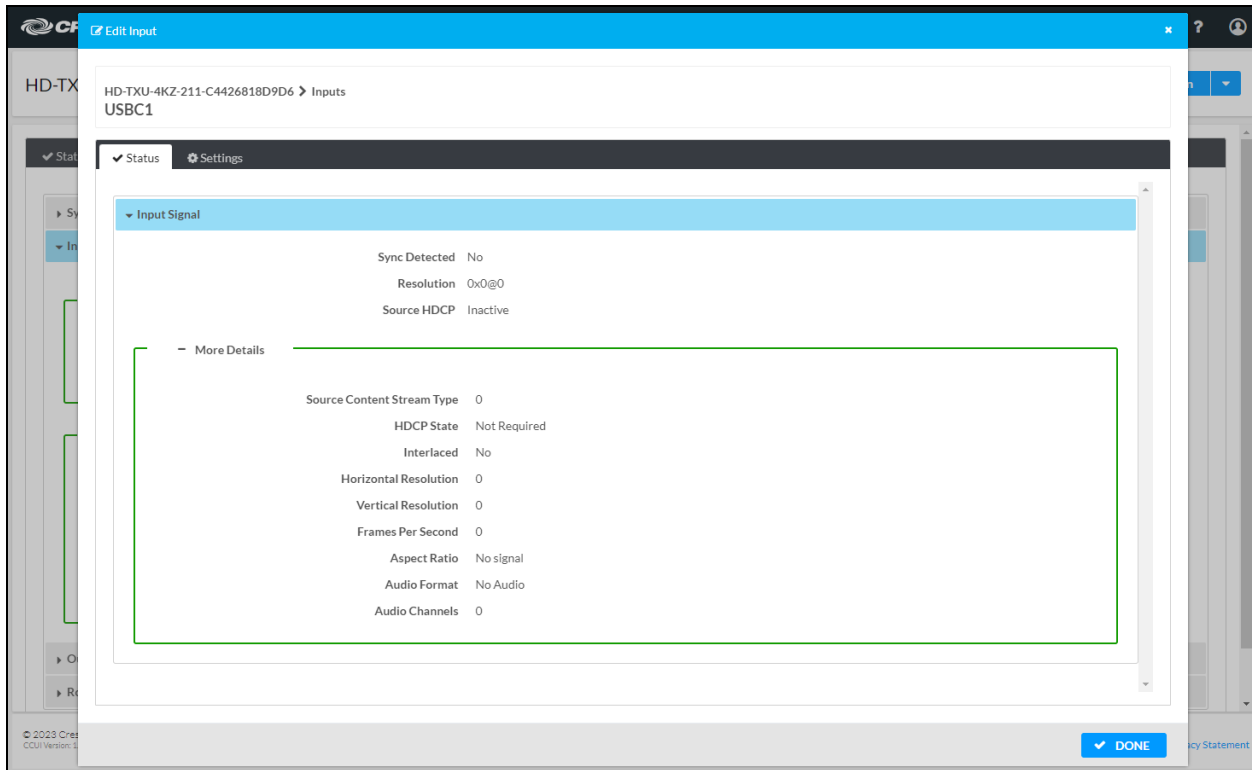

The **Status** tab displays the following information about the input signal:

- Sync Detected
- Resolution
- Source HDCP

The **More Details** section displays the following information:

- Source Content Stream Type
- HDCP State
- Interlaced
- Horizontal Resolution
- Vertical Resolution
- Frames Per Second
- Aspect Ratio
- Audio Format
- Audio Channels

Select **DONE** to close the **Edit Input** pop-up dialog box.

Outputs

To view information about the outputs on the DM Essentials device or to configure the outputs: Open the **Settings** tab and navigate to **Outputs**.

Settings Tab - Outputs (HD-TX-4KZ-211 Shown)

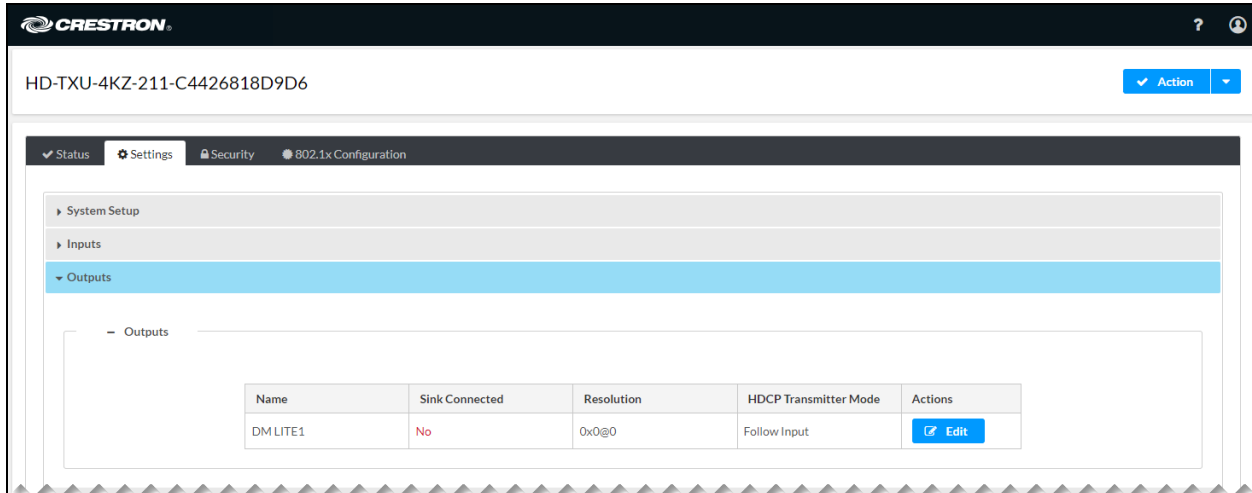

The Outputs table displays the following information:

- **Name:** Indicates the name assigned to the output.
- **Sink Connected:** For the HD-TXU-4KZ-211(-CHGR), displays whether the DM Essentials output is connected to the HD-RXU-4KZ-202 (Yes or No). For the HD-RXU-4KZ-202, displays whether a display device is connected to an HDMI output (Yes or No).
- **Resolution:** Indicates the current resolution of the output. If **0x0@0** is displayed, no video signal is being transmitted.
- **HDCP Transmitter Mode:** Indicates one of the following: **Follow Input**, **Force Highest**, or **Never Authenticate**.

To view additional output settings or to edit output settings, select the **Edit** button in the **Actions** column of the table. The **Edit Output** pop-up dialog box opens.

Edit Output Pop-Up Dialog Box (HD-TXU-4KZ-211 Shown)

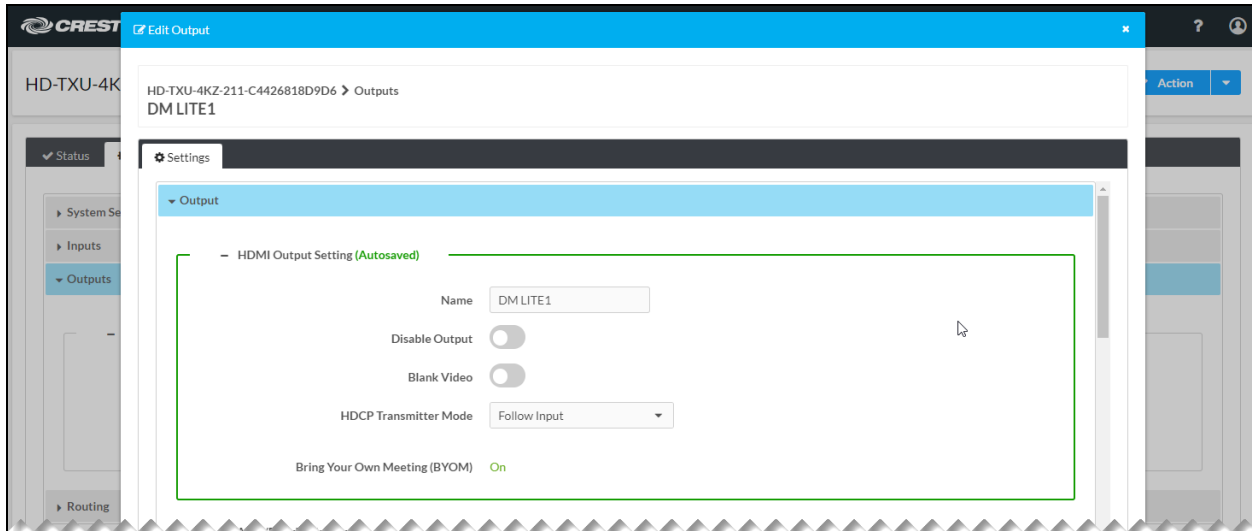

The **Edit Output** pop-up dialog box consists of the following sections:

- [HDMI output setting](#)
- [Auto/priority settings](#) (applicable only when automatic routing is enabled)
- [Connected display](#)
- [Output signal](#)
- [Audio settings](#) (HD-RXU-4KZ-202 only)
- [Automatic display power](#)

HDMI Output Setting

In the **HDMI Output Setting** section of the **Edit Output** dialog box, edit the settings of an HDMI output as required.

NOTE: For the HD-TXU-4KZ-211(-CHGR), the HDMI output is the HDMI output of a DM Essentials receiver that is connected to the HD-TXU-4KZ-211(-CHGR) via the DM Essentials connection.

Edit Output Pop-Up Dialog Box - HDMI Output Setting (HD-TXU-4KZ-211 Shown)

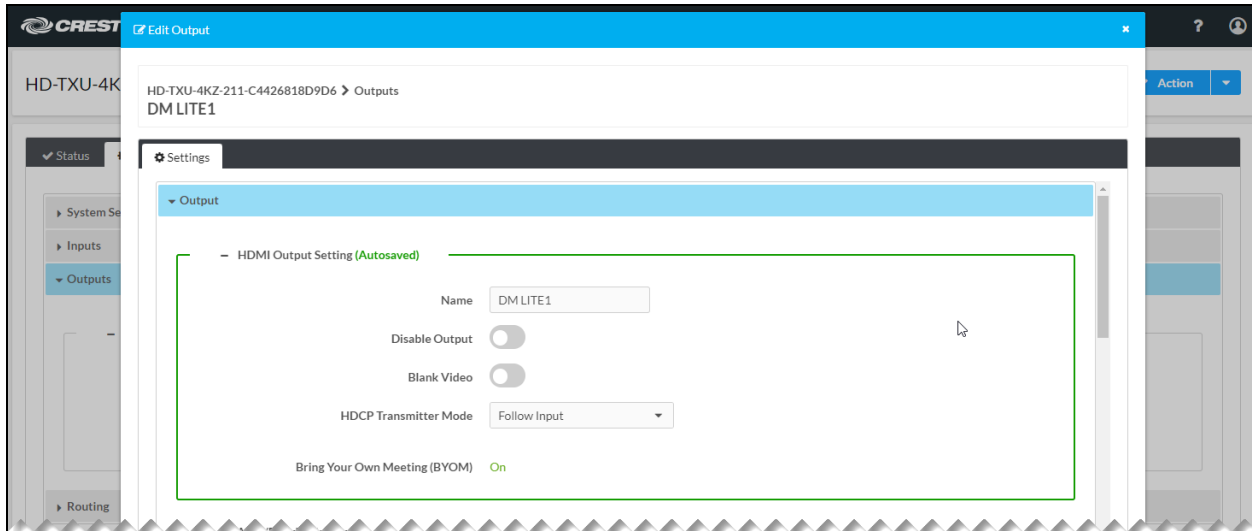

Refer to the configuration guidelines that follow.

- **Name:** Enter the desired name of the output. For the HD-TXU-4KZ-211(-CHGR), the default name is **DM LITE 1**. For the HD-RXU-4KZ-202, the default name is **HDMI 1** or **HDMI 2**.
- **Disable Output:** By default, **Disable Output** is disabled (the toggle switch is set in the Off position) and the HDMI output is enabled. To disable the HDMI output, set the toggle switch in the On position.
- **Blank Video:** By default, **Blank Video** is disabled (the toggle switch is set in the Off position). When disabled, the video signal is not displayed but audio can still be heard. To blank the video, set the toggle switch in the On position.
- **HDCP Transmitter Mode:** Select one of the following:
 - **Follow Input:** Enables HDCP for the output only when the input requires HDCP. The output uses the HDCP level reported at the input. If the input does not require HDCP, HDCP is disabled for the output.
 - **Force Highest:** Enables HDCP for the output regardless of the input requirements. The highest level of HDCP supported by the output is used.
 - **Never Authenticate:** Disables HDCP for the output regardless of the input requirements.

Auto/Priority Settings

The **Auto/Priority** section of the **Edit Output** dialog box enables control of the routing priority of the inputs on the device.

NOTE: In order to configure the routing priority of inputs, automatic routing must be enabled in the **Settings > Routing** section of the web interface.

Edit Output Dialog Box - Auto/Priority Settings (HD-TXU-4KZ-211 Shown)

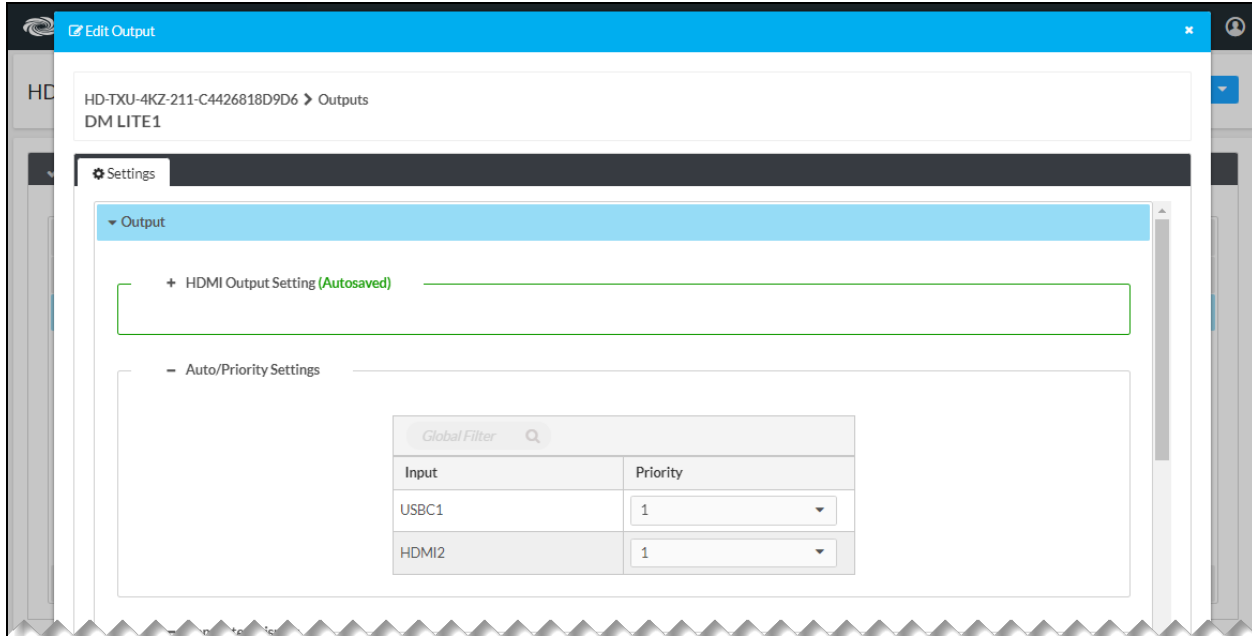

The **Auto/Priority** section provides an input priority routing table:

- The **Global Filter** search box at the top of the table enables searching for an input based on the input name.
- The **Input** column lists the input names of the DM Essentials device.
- The **Priority** column enables the routing priority to be set for each input by selecting one of the following:
 - **0:** Disables routing priority.
 - **1:** (Default setting) Sets the routing priority level to the higher priority.
 - **2:** Sets the routing priority level to the lower priority.

For routing priorities **1** and **2**, automatic routing of an input to the output occurs based on the routing priority level and the detection of a source at the input. Routing of an input remains until the input is disconnected, and routing then switches to another input based on the routing priority level and detection of a source at the input. If priority **1** is set for both inputs, the last connected input is automatically routed.

Connected Display

The **Connected Display** section of the **Edit Output** dialog box displays information about the connected display device.

Edit Output Dialog Box - Connected Display (HD-TXU-4KZ-211 Shown)

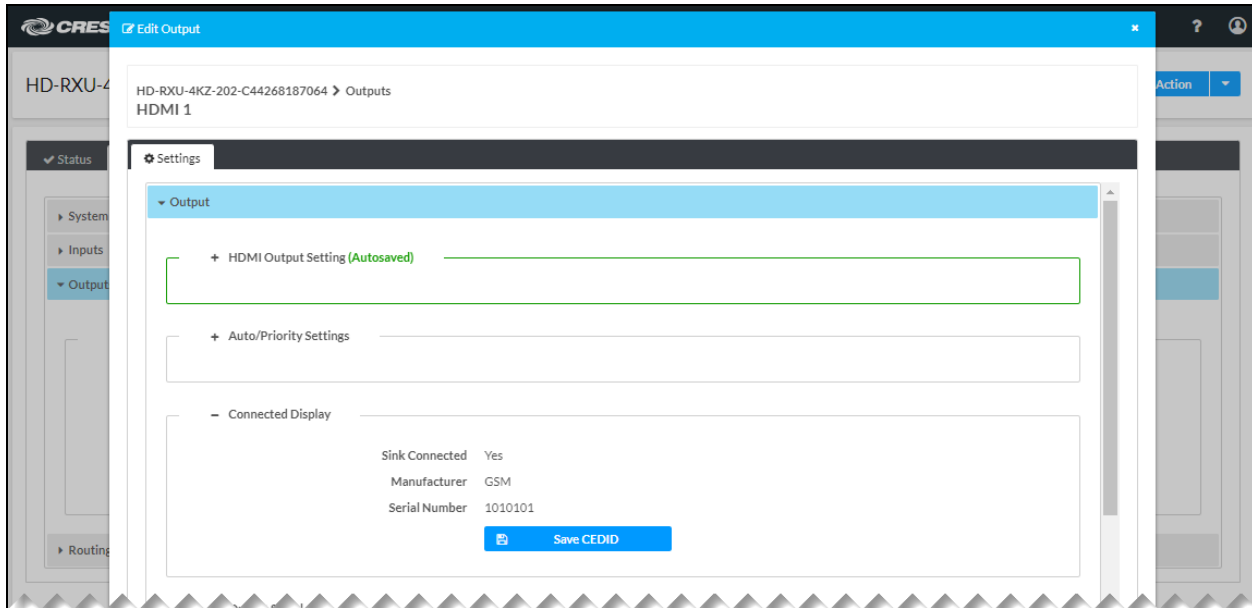

The following information is displayed:

- **Sink Connected:** Indicates whether the HDMI output is connected to a display device (**Yes** or **No**)
- **Manufacturer:** Indicates the manufacturer of the connected display device
- **Serial Number:** Indicates the serial number of the connected display device

To download the EDID file (**sink.cedid**) of the connected display to a computer, select the **Save CEDID** button.

Output Signal

The **Output Signal** section of the **Edit Output** dialog box displays information about the HDMI output signal.

Edit Output Dialog Box - Output Signal (HD-TXU-4KZ-211 Shown)

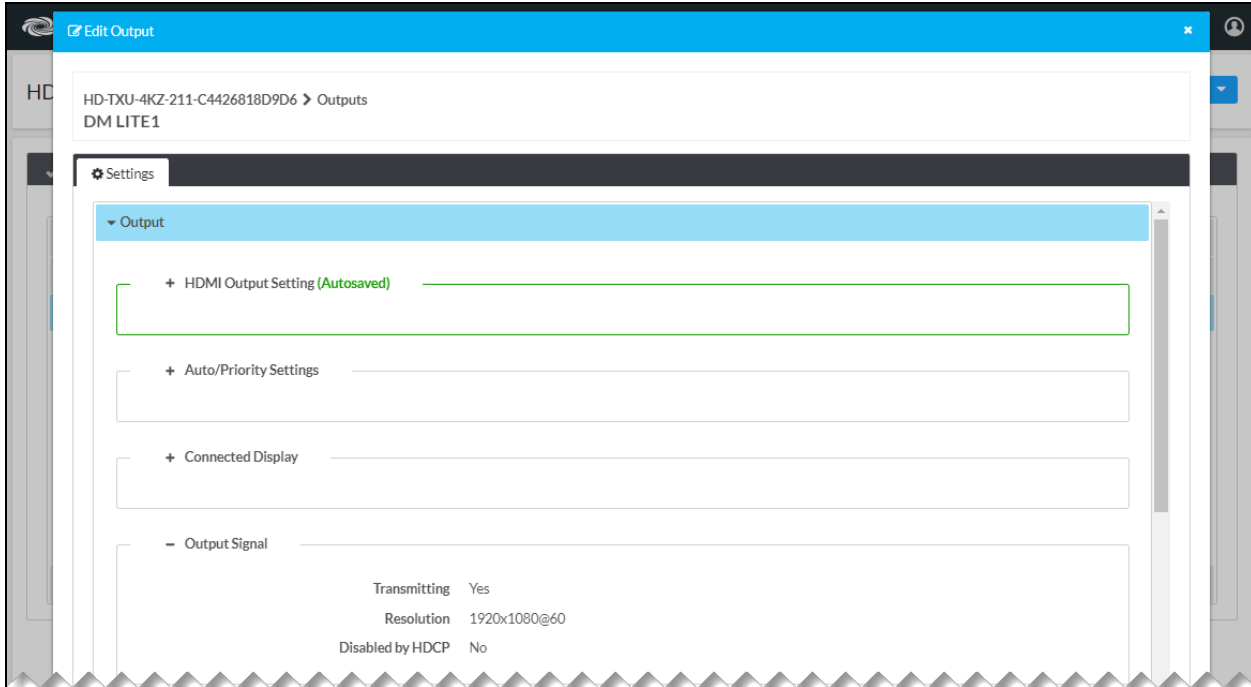

The following information is displayed:

- **Transmitting:** Displays whether the output signal is being transmitted to the display device (**Yes** or **No**)
- **Resolution:** Displays the resolution of the output signal
- **Disabled by HDCP:** Displays whether the output signal is disabled by HDCP (**Yes** or **No**). If **Yes** is displayed, video is not being transmitted but audio is being transmitted. If **No** is displayed, both video and audio are being transmitted.

Audio Settings (HD-RXU-4KZ-202 Only)

The **Audio Settings** section of the **Edit Output** dialog box enables the HDMI output to be muted or unmuted.

Edit Output Dialog Box - Audio Settings (HD-TXU-4KZ-211 Shown)

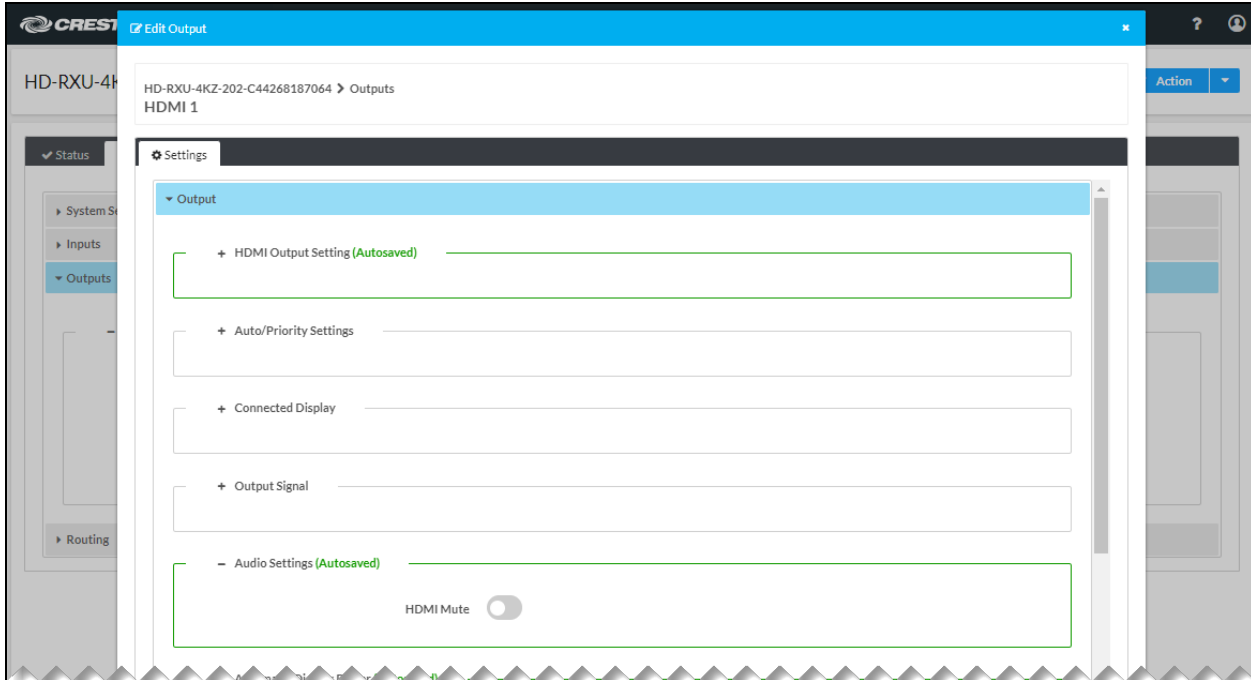

By default, **HDMI Mute** is disabled (the toggle switch is set in the Off position), enabling the HDMI output to be unmuted. To mute the HDMI output, set the toggle switch in the On position.

Automatic Display Power

The **Automatic Display Power** section of the **Edit Output** dialog box enables the HDMI output to be configured so that the display device can be powered on or off automatically.

Edit Output Dialog Box - Automatic Display Power (HD-TXU-4KZ-211 Shown)

The screenshot shows the 'Edit Output' dialog box for 'Automatic Display Power (Autosaved)'. The window title is 'Edit Output'. The breadcrumb path is 'HD-TXU-4KZ-211-C4426818D9D6 > Outputs DM LITE1'. A 'Settings' tab is active. The configuration is as follows:

- Automatic Power:**
- Automatic Power Trigger:** Sync, Occupancy, Schedule
- Power Schedule:** Select Schedule (Error: Power Schedule is required)
- Manage Schedules:** [Button]
- Occupancy Sensor:** Select Occupancy (Error: Occupancy Sensor is required)
- Manage Occupancy Sensor:** [Button]
- Command Interface:** CEC (Info icon)
- Command Format:** Hex
- Command Terminator:** None
- Output Timeout:** 5 Seconds
- Power Off:**
 - Command:** Power Off: RCP and SS
 - Test:** [Button]
- Clear Route:** (Info icon)
- Power On:**
 - Command:** Power On: RCP and IVO
 - Test:** [Button]
- InputControl:**
- Select Source:** None (Info icon)

[DONE]

Refer to the configuration guidelines that follow.

Automatic Power: By default, **Automatic Power** is enabled (the toggle switch is set in the On position). To disable **Automatic Power**, set the toggle switch in the Off position.

If **Automatic Power** is enabled, configure the following settings:

- **Automatic Power Trigger:** Select one of the following:
 - **Select All:** Select the checkbox to specify that automatic display power is based on all available selections: **Sync**, **Occupancy**, and **Schedule**.
 - **Sync:** (Default setting) Specifies that automatic display power is based on the detection of a signal at the HDMI output (yes or no)
 - **Occupancy:** Specifies that automatic display power is based on the occupancy status of a room (unknown, occupied, or unoccupied). If **Occupancy** is selected, occupancy sensor information must be set. Refer to **Occupancy Sensor** below for information.
 - **Schedule:** Specifies that automatic display power is based on a schedule. If **Schedule** is selected, the desired schedule must be set. Refer to [Managing Schedules](#) for information about setting one or more schedules.
- **Power Schedule:** (Applicable only when a schedule is included as an automatic power trigger) Select the desired schedule. If no schedule is listed or if the desired schedule is not listed, select the **Manage Schedules** button. Refer to [Managing Schedules](#) for information about adding one or more schedules.
- **Occupancy Sensor:** (Applicable only when an occupancy sensor is included as an automatic power trigger) Select **Control System** or the desired occupancy sensor. If the desired occupancy sensor is not listed, select the **Manage Occupancy Sensor** button. Refer to [Managing Occupancy Sensors](#) for information about adding an occupancy sensor.
- **Command Interface:** Select one of the following:
 - **CEC:** Specifies that a CEC command is to be sent via the HDMI output
 - NOTE:** CEC will occur only when an HD-RXU-4KZ Series receiver or a supported HDBaseT receiver is connected to the HDMI output.
 - **Drivers:** Specifies that a command is to be sent from a driver

- For **CEC** command interface only: Configure the following:
 - **Command Format:** Select **Hex** (hexadecimal) or **ASCII**. The default setting is **Hex**.
 - **Command Terminator:** Select one of the following to append to the command:
 - **None:** No terminator (default setting)
 - **CR:** Carriage return
 - **LF:** Line feed
 - **CR_LF:** Carriage return followed by a line feed
- For **Drivers** command interface only: Select the driver. The only available option is **Crestron-CEC-Controlled-Display-2.05.001.0032**.
- **Output Timeout:** Specifies the number of seconds that must pass in which no signal is detected at the HDMI output before the output becomes inactive and the display device automatically turns off.
Enter or select the desired number of seconds. Valid values range from **1–600** seconds. The default setting is **5**.

For **CEC** and **Drivers** command interfaces, configure **Power Off** and **Power On** settings as applicable. Refer to the [Power Off and Power On Using CEC](#) and [Power Off and Power On Using a Driver](#) sections, respectively, for information.

Power Off and Power On Using CEC

When **CEC** is the command interface, configure **Power Off** and **Power On** settings as discussed below.

Power Off and Power On Configuration Using CEC

The screenshot shows a configuration window with two main sections: "Power Off" and "Power On".

Power Off Section:

- Command: Power Off: RCP and SS (dropdown menu)
- Test: (blue button)
- Clear Route: (toggle switch, currently off, with an information icon)

Power On Section:

- Command: Power On: RCP and IVO (dropdown menu)
- Test: (blue button)
- InputControl: (toggle switch, currently off)
- Select Source: None (dropdown menu, with an information icon)

At the bottom right of the window is a blue button with a checkmark and the text "DONE".

- **Command:** Do the following as applicable:
 - For **Power Off** using **CEC**, select one of the following in the **Command** drop-down list:
 - **Power Off: RCP and SS** (Default setting, Remote Control Passthrough and System Standby)
 - **Power Off: RCP Only**
 - **Power Off: SS Only**
 - **Custom**

If a setting other than **Custom** is selected, select the **Test** button to test the command.

- For **Power On** using **CEC**, select one of the following in the **Command** drop-down list:
 - **Power On: RCP and IVO** (Default setting, Remote Control Passthrough and Image View On)
 - **Power On: RCP**
 - **Power On: Image View On**
 - **Custom**

If a setting other than **Custom** is selected, select the **Test** button to test the command.

- **Command String:** (Applicable only when **Command** is set to **Custom**) Enter a valid command string for CEC. The maximum length is 128 characters.

NOTE: If the command format is **Hex**, the command string must be entered as pairs of characters separated by a space. Valid characters are 0-9, a-f, and A-F. An example of a command string is as follows:

```
58 00 0D 0A
```

Select the **Test** button to test the custom command.

- **Clear Route:** (Applicable to **Power Off** only) By default, **Clear Route** is disabled (the toggle switch is set in the Off position). To enable **Clear Route**, set the toggle switch in the On position. When enabled, **Clear Route** clears the route after the number of seconds specified in the **Output Timeout** setting.
- **Input Control:** (Applicable to **Power On** only) By default, **Input Control** is disabled (the toggle switch is set in the Off position). To enable **Input Control**, set the toggle switch in the On position. When enabled, **Input Control** allows an additional command to be sent after the **Power On** command is sent. The **Input Control** command ensures that the proper HDMI input is selected on the display device.

Configure **Input Control** as follows:

- **Delay:** Select the number of seconds that must pass after the **Power On** command is sent in order for the **Input Control** command to be sent. Values are **0 seconds, 3 seconds, 5 seconds, 7 seconds, 10 seconds, and 20 seconds**. The default setting is **5 seconds**.
- **Command String:** Enter a valid command string. The maximum length is 128 characters.

NOTE: If the command format is **Hex**, the command string must be entered as pairs of characters separated by a space. Valid characters are 0-9, a-f, and A-F. An example of a command string is as follows:

58 00 0D 0A

Select the **Test** button to test the **Input Control** command.

- **Select Source:** (Applicable to **Power On** only) Select **None** or the desired input. The default setting is **None**.

The selected source will be routed after an Automatic Display Power On event. If automatic routing is enabled and **Power On** is triggered by **Sync**, standard automatic routing logic applies.

To close the **Edit Output** pop-up dialog box, select the **DONE** button at the bottom of the dialog box.

Power Off and Power On Using a Driver

When **Drivers** is the command interface, configure **Power Off** and **Power On** settings as discussed below.

Power Off and Power On Configuration Using a Driver

The screenshot shows a dialog box titled "Edit Output" with a light gray background. It is divided into two main sections: "Power Off" and "Power On".

- Power Off section:** Contains a blue "Test" button.
- Clear Route section:** A light beige bar containing a toggle switch labeled "Clear Route" (currently in the "Off" position) and a yellow information icon.
- Power On section:** Contains a blue "Test" button.
- Select Source section:** A light beige bar containing a dropdown menu labeled "Select Source" with "None" selected and a yellow information icon.

At the bottom right of the dialog box, there is a blue button with a white checkmark and the text "DONE".

For **Power Off** only:

By default, **Clear Route** is disabled (the toggle switch is set in the Off position). To enable **Clear Route**, set the toggle switch in the On position. When enabled, **Clear Route** clears the route after the number of seconds specified in the **Output Timeout** setting.

For **Power On** only:

Select Source: Select **None** or the desired source. The default setting is **None**.

The selected source will be routed after an Automatic Display Power On event. If automatic routing is enabled and **Power On** is triggered by **Sync**, standard automatic routing logic applies.

To close the **Edit Output** pop-up dialog box, select the **DONE** button at the bottom of the dialog box.

Bring Your Own Meeting (BYOM)

To configure settings for routing USB peripherals, open the **Settings** tab and navigate to **Bring Your Own Meeting (BYOM)**. The available settings differ between the transmitter and receiver interfaces as described below.

HD-RXU-4KZ-202

Settings Tab - Bring Your Own Meeting (BYOM) (HD-RXU-4KZ-202)

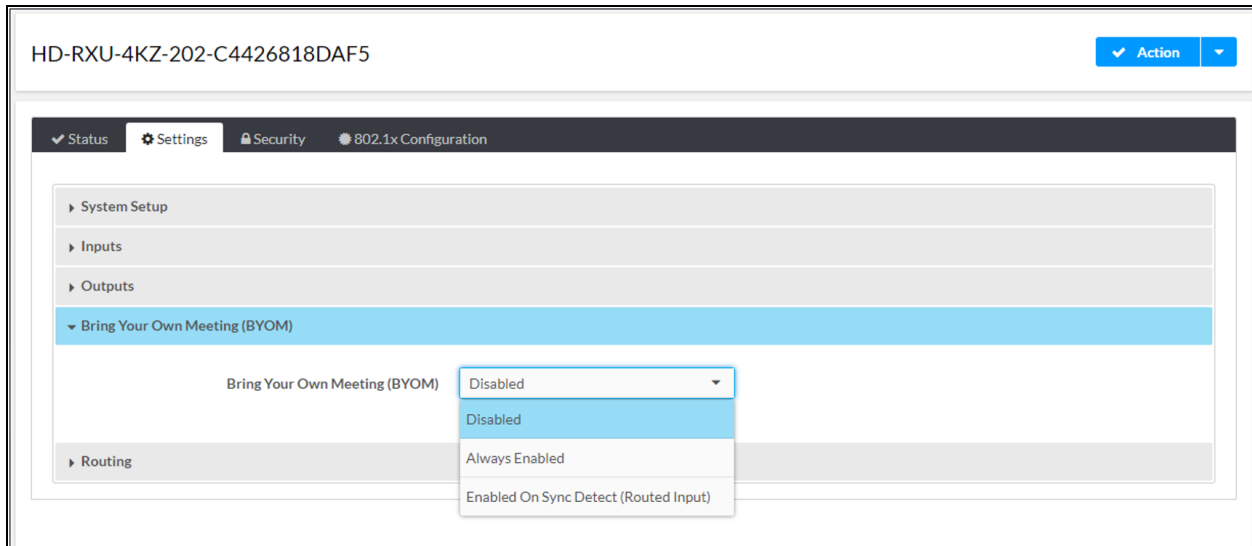

Choose a setting from the **Bring Your Own Meeting (BYOM)** drop down:

- **Disabled:** USB peripherals connected to the **HOST** ports of the HD-RXU-4KZ-202 are only available to the **DEVICE** port of the HD-RXU-4KZ-202. **Disabled** is the default setting.
- **Always Enabled:** USB peripherals connected to the **HOST** ports of the HD-RXU-4KZ-202 are only available to the **DEVICE** or **INPUT USB** port of a connected transmitter.
- **Enabled On Sync Detect (Routed Input):** USB peripherals connected to the **HOST** ports of the HD-RXU-4KZ-202 are routed to the **DEVICE** or **INPUT USB** port of the connected transmitter when video sync is detected from the transmitter. When no video sync is detected, the USB peripherals are only available to the **DEVICE** port of the HD-RXU-4KZ-202.

NOTE: When paired with an HD-TXU-4KZ-211 or HD-TXU-4KZ-211-CHGR transmitter, BYOM settings must also be configured on the transmitter.

HD-TXU-4KZ-211 and HD-TXU-4KZ-211-CHGR

Settings Tab - Bring Your Own Meeting (BYOM) (HD-TXU-4KZ-211 and HD-TXU-4KZ-211-CHGR)

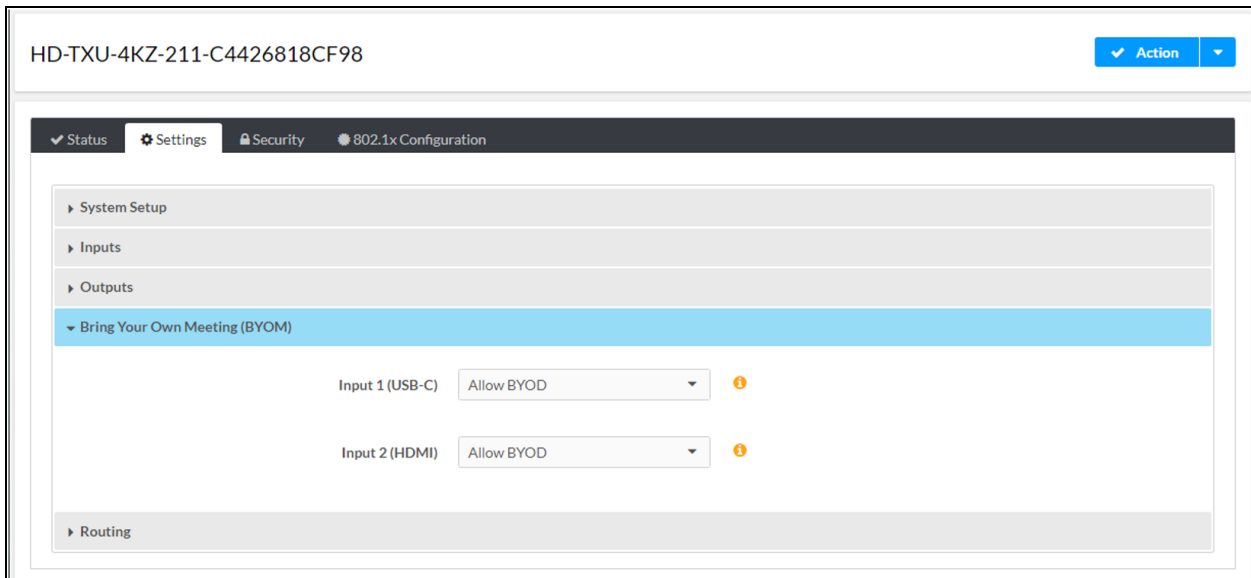

The BYOM settings of each USB input of the HD-TXU-4KZ-211(-CHGR) can be configured independently.

Choose a setting from the desired input drop down:

- **Allow BYOD:** The **HOST** ports of the HD-TXU-4KZ-211(-CHGR) supply +5V USB power only when video sync or USB connection is detected at the input. **Allow BYOD** is the default setting.

NOTE: When paired with an HD-RXU-4KZ-202 receiver, USB routing behavior will be determined by the BYOM settings on the receiver.

- **Presentation Only:** USB connectivity is disabled for the input. Select this mode to pass audio/video content only.

Routing

To route an input to one or more outputs:

Open the **Settings** tab and navigate to **Routing**.

Settings Tab - Routing (HD-TXU-4KZ-211 Shown)

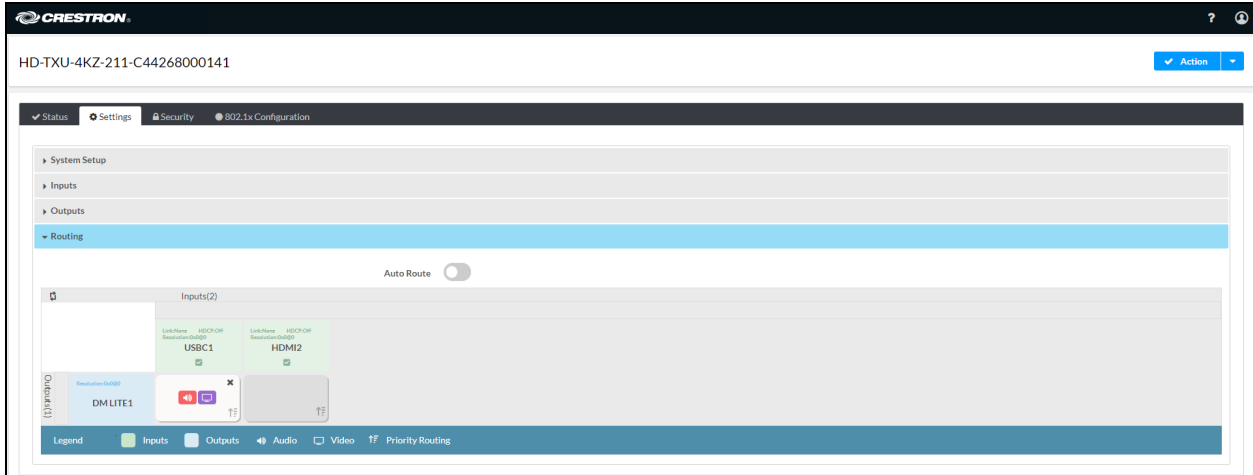

Settings Tab - Routing (HD-RXU-4KZ-202 Shown)

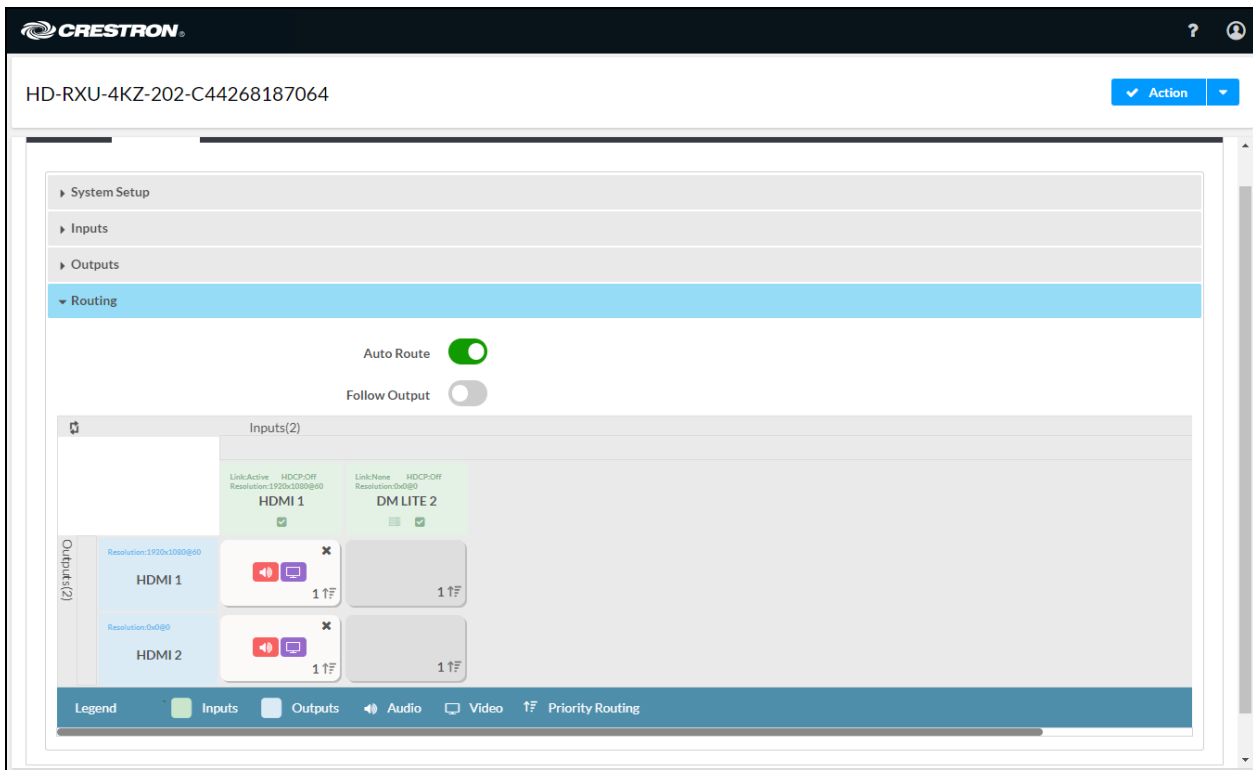

Refer to the configuration guidelines that follow.

- **Auto Route:** By default, automatic routing is enabled (the toggle switch is set in the On position). When **Auto Route** is enabled and priority routing is disabled for an input, the last connected input is automatically routed. To disable automatic routing, set the toggle switch in the Off position.

NOTE:

- **Auto Route** must be enabled in order to set the [routing priority](#) of the inputs.
- **Follow Output:** (Applicable to the HD-RXU-4KZ-202 only) Controls whether the audio and video that is routed to output 1 is also routed to output 2. By default, **Follow Output** is disabled (the toggle switch is set in the Off position). To enable the audio and video routed to output 1 to also be routed to output 2, set the toggle switch in the On position.

The Routing section provides an AV routing table consisting of inputs and outputs. The inputs are shaded green and are identified by the input name. In addition, the following information is provided about the inputs:

- **Link:** Indicates whether the input is connected to a source device. If the input is not connected, **None** is displayed. If the input is connected, **Active** is displayed.
- **HDCP:** Indicates whether HDCP is **On** or **Off**.
- **Resolution:** Indicates the resolution of the video. If no video is present, **0x0@0** is displayed.

The total number of inputs is labeled as **Inputs(2)** for the two inputs on the device.



The outputs are shaded blue and are identified by the output name. The **Resolution** is also displayed. If no video is present, **0x0@0** is displayed. In addition, the total number of outputs is labeled. For the HD-TXU-4KZ-211 and HD-TXU-4KZ=211-CHGR, the number of outputs is labeled as **Outputs(1)** for the single output on the device. For the HD-RXU-4KZ-202, the number of outputs is labeled as **Outputs(2)** for the two outputs on the device.

As shown above, the default view of the AV routing table displays the outputs in the first column of the table. To swap the inputs and outputs so that the inputs are displayed in the first column, select the Swap icon (↔).

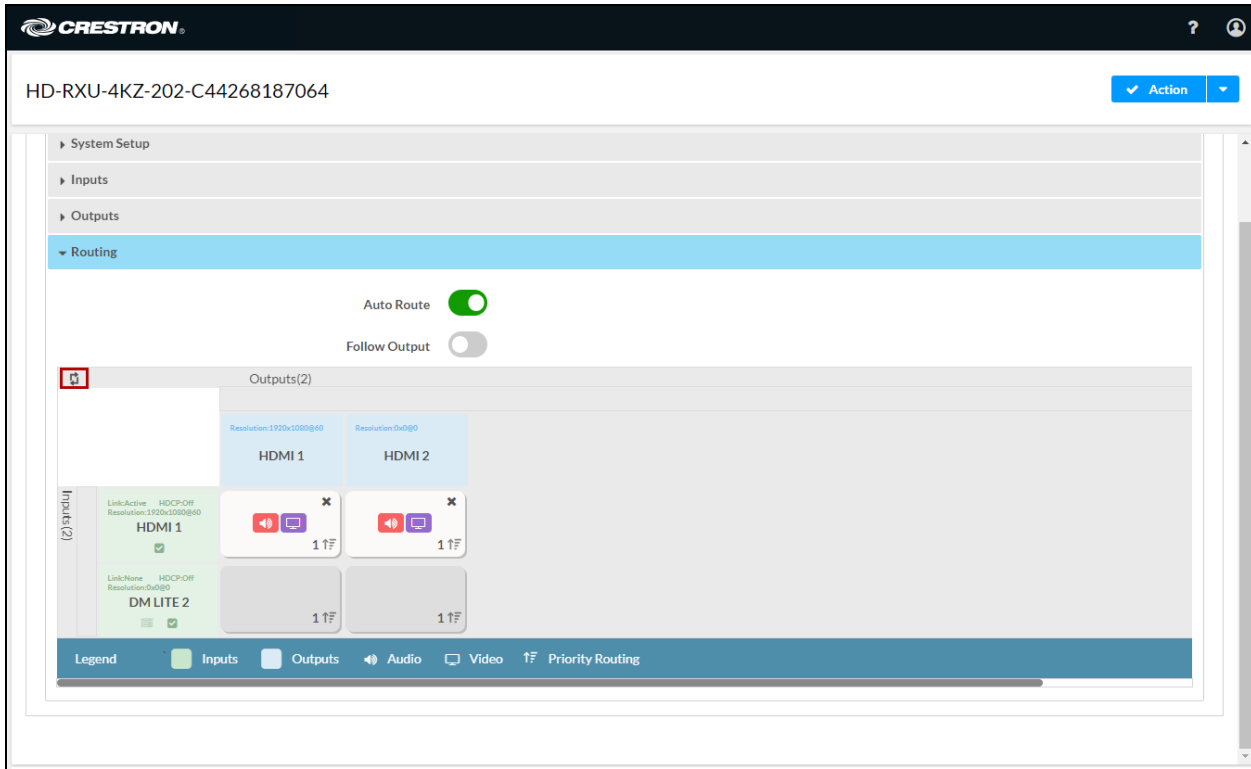
Routing Table Shown with Inputs in First Column



Within a routing cell of the AV routing table, signal type icon buttons represent the two signal types to be routed:

-  : Pink icon represents audio.
-  : Purple icon represents video.

NOTE: Audio and video cannot be routed separately.

If no route is made between an input and output, the routing cell is shaded gray.

The lower-right corner of the routing cell contains the Priority Routing icon () preceded by the current routing priority level of the input (**0**, **1**, or **2**).

NOTE: The Priority Routing icon is functional only when **Auto Route** is enabled.

To change the routing priority of an input:

1. Select the Priority Routing icon (1). The Priority Routing pop-up dialog box opens.

Priority Routing Pop-Up Dialog Box

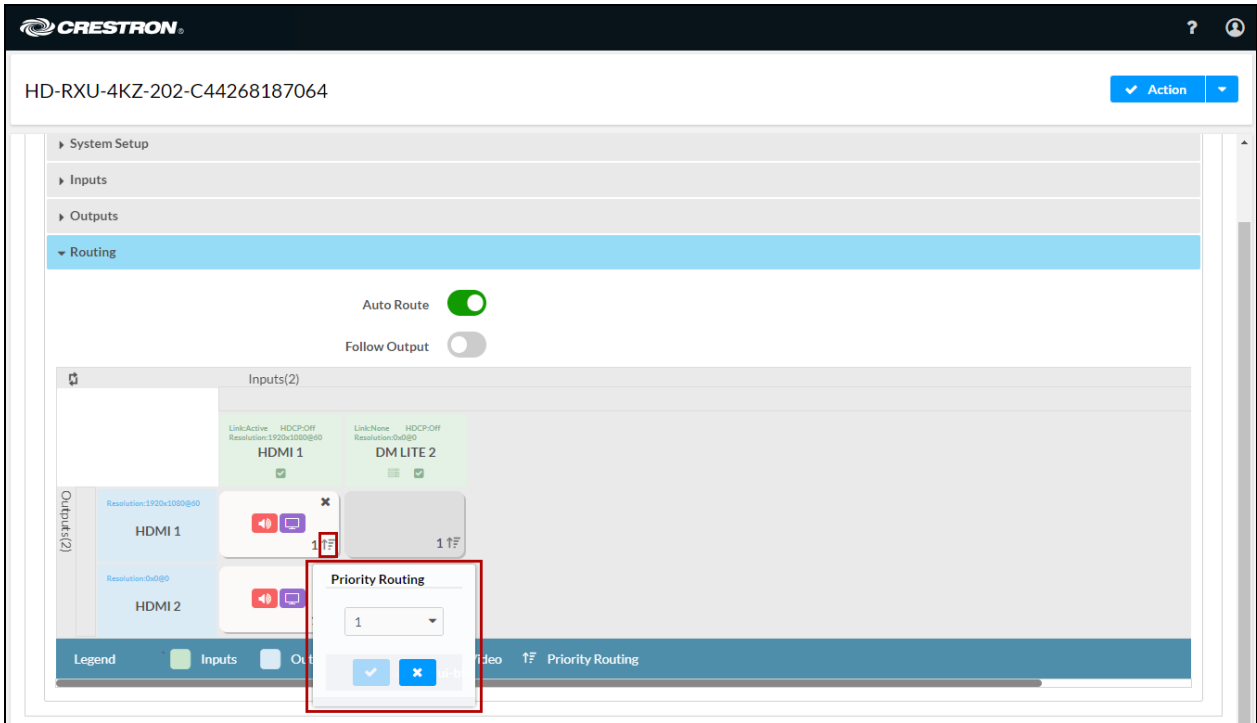

2. In the drop-down list, select the desired routing priority level:

- **0:** Disables priority routing.
- **1:** Sets the routing priority level to the higher priority.
- **2:** Sets the routing priority level to the lower priority.

For routing priorities **1** and **2**, automatic routing of an input to one or more outputs occurs based on the routing priority level and the detection of a source at the input. Routing of an input remains until the input is disconnected, and routing then switches to the remaining input based on the routing priority level and detection of a source at the input. If priority **1** is set for both inputs, the last connected input is automatically routed.

To manually route an input to one or more outputs using the web interface:

- For the HD-TXU-4KZ-211(-CHGR), select the routing cell of the desired input for routing to the DM Essentials output.
- For the HD-RXU-4KZ-202, select the routing cell of each desired input for routing to the desired HDMI output.

To manually clear a route:

In the routing cell that contains the route to be cleared, select the **x** in the upper-right corner of the cell.

Clear Route

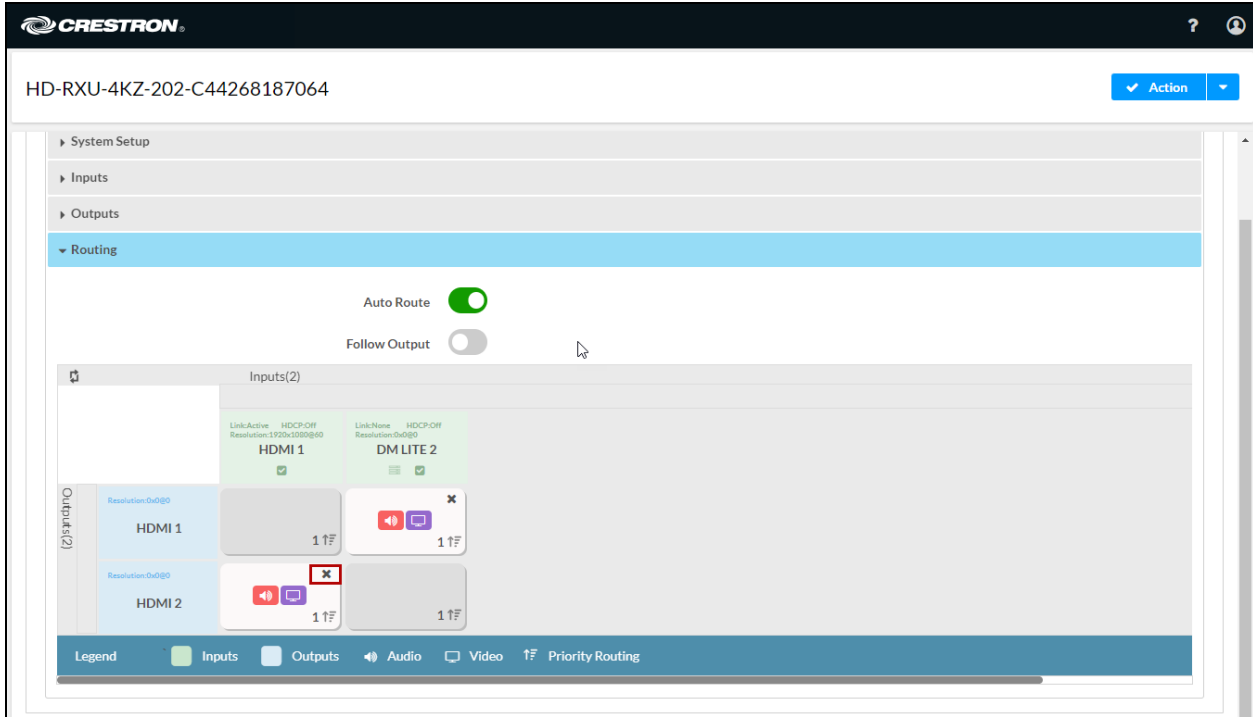

The route is cleared and the routing cell is shaded gray.

Route Cleared

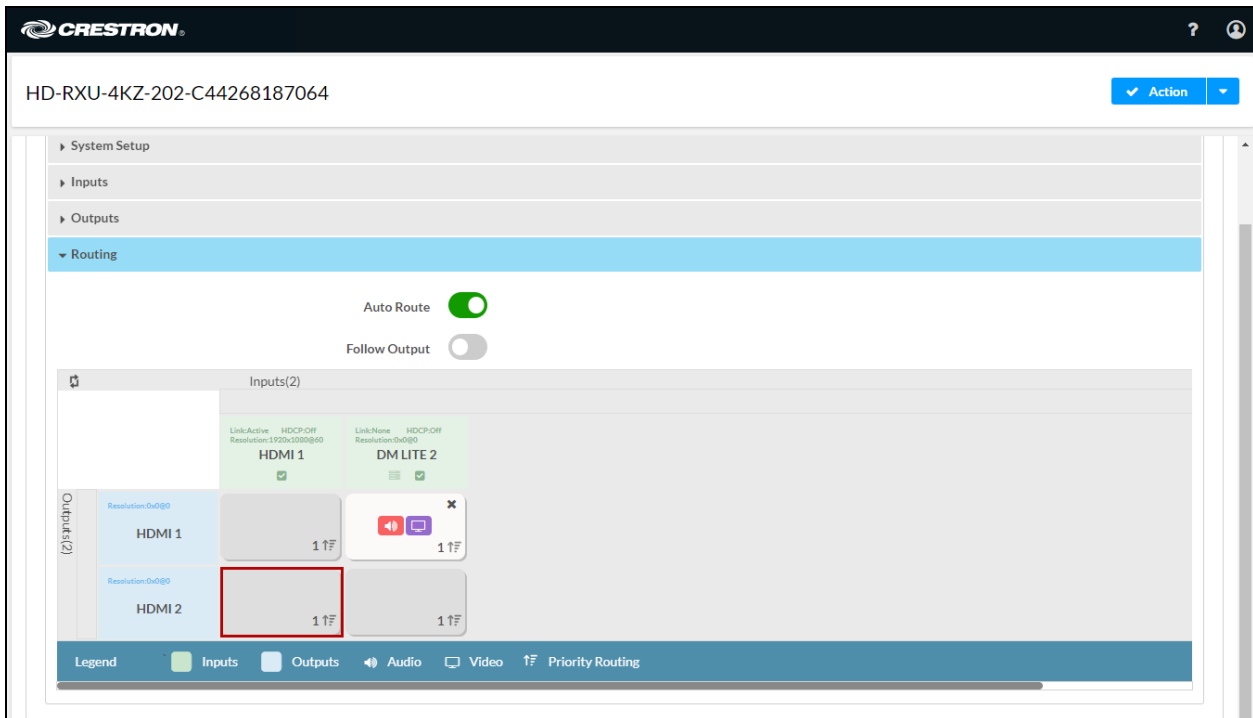

When a transmitter with multiple inputs (such as the HD-TXU-4KZ-211) is connected to the HD-RXU-4KZ-202, a Multiple Input Sources icon () appears under the input name associated with its DM Essentials input port.

To select which input of the transmitter should be sent over the DM Essentials link:

1. Click the Multiple Input Sources icon (). The **Multiple Input Sources** window opens.

Multiple Input Sources Icon (HD-RXU-4KZ-202 Shown)

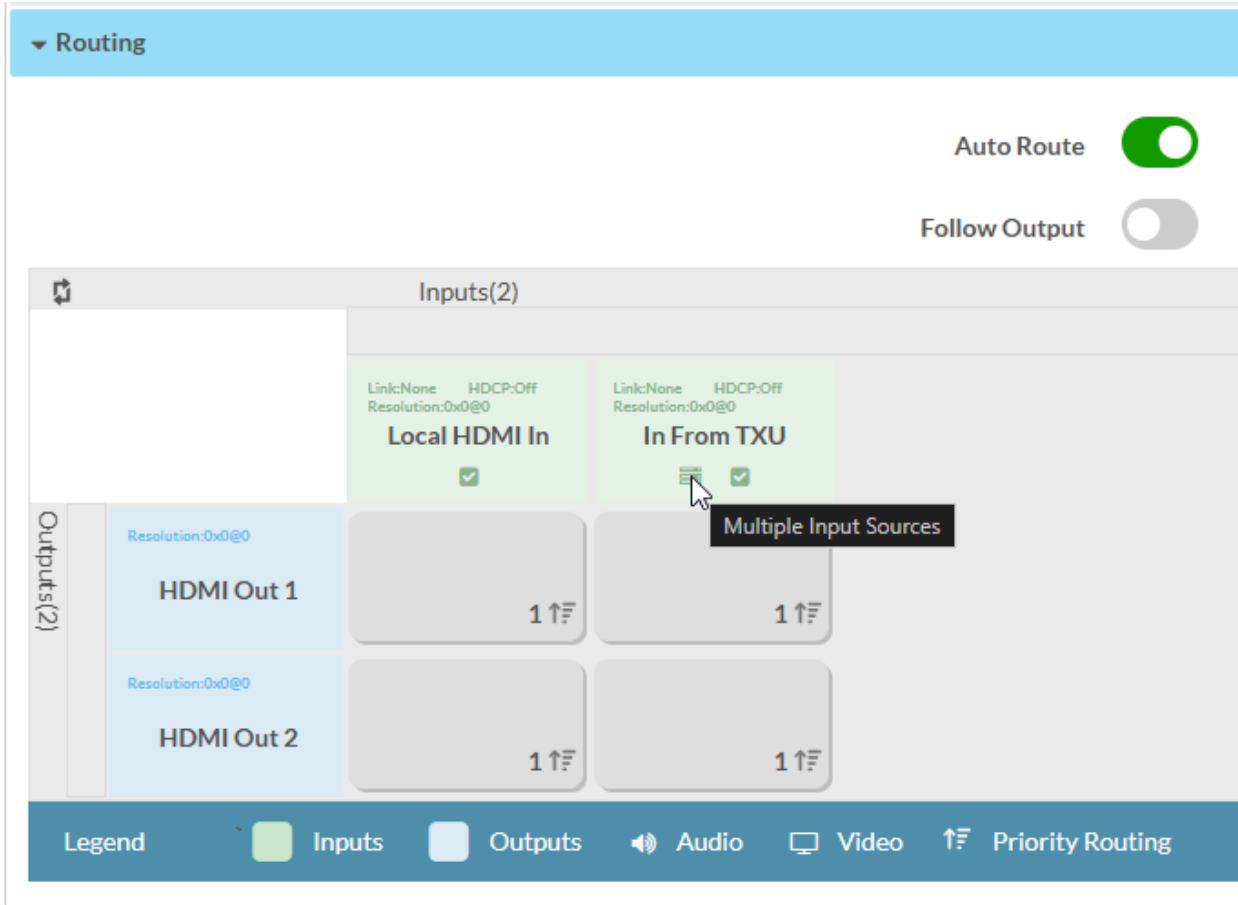

2. Select the desired input in the routing matrix, then close the **Multiple Input Sources** window.

Multiple Input Sources Window

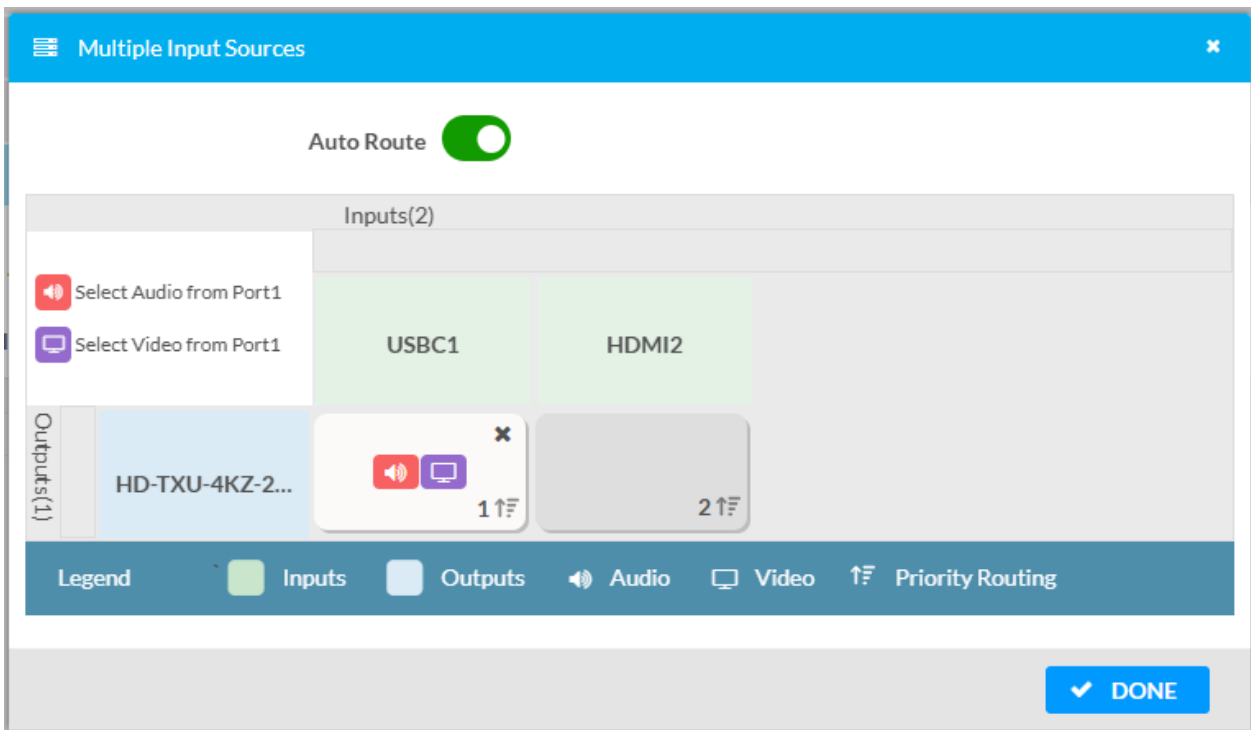

Configuring Security Settings

Select the **Security** tab to configure [SSL \(Secure Sockets Layer\) mode](#) and [authentication management](#) settings.

Security Tab

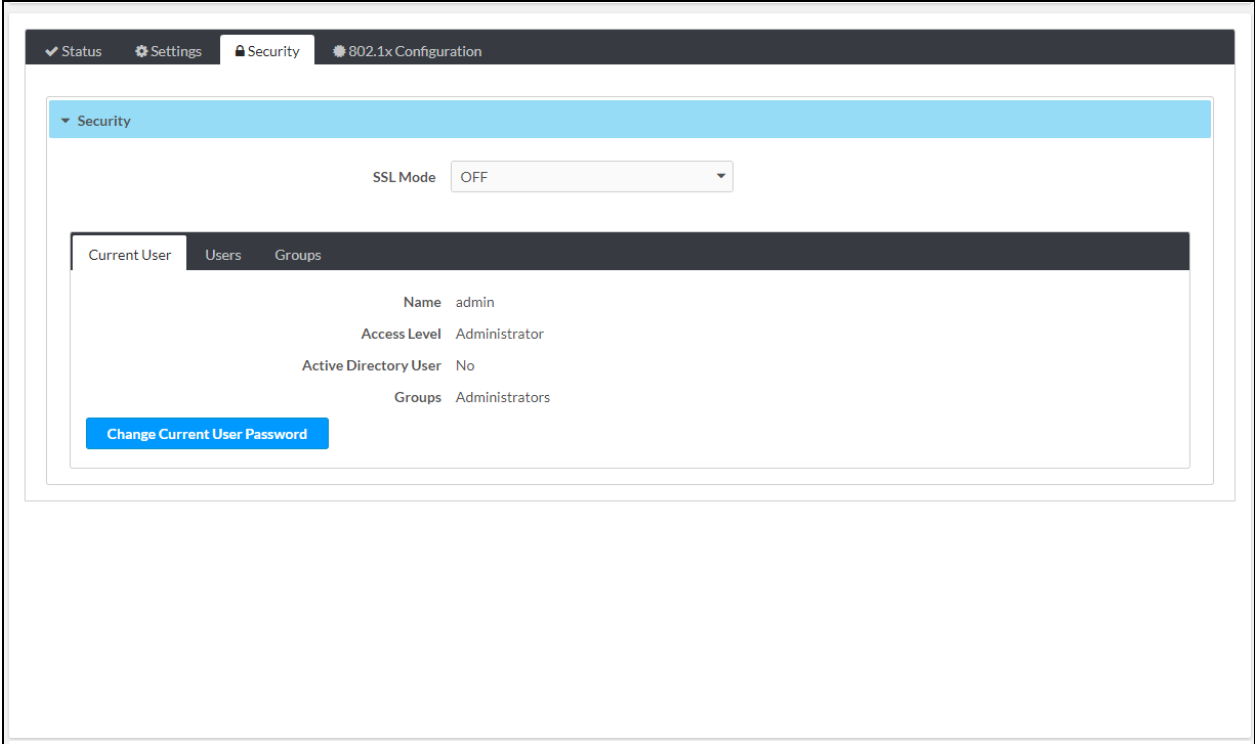

SSL Mode

SSL mode can be disabled or enabled. When enabled, SSL encryption, validation, or both can be set.

Security Tab - SSL Mode (Encrypt and Validation Selection Shown)

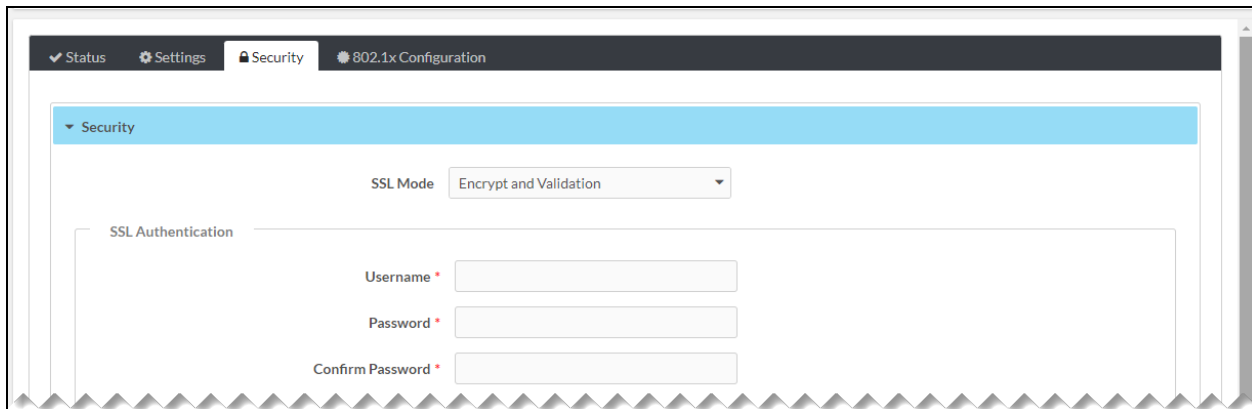

The screenshot shows the 'Security' tab in the '802.1x Configuration' interface. The 'SSL Mode' dropdown menu is set to 'Encrypt and Validation'. Below this, the 'SSL Authentication' section is visible, containing three text input fields: 'Username', 'Password', and 'Confirm Password', each with a red asterisk indicating it is a required field.

In the **SSL Mode** drop-down list, select one of the following:

- **Encrypt and Validation:** Specifies both encryption and validation and enables configuration of SSL authentication in the following text boxes:
 - **Username:** Enter the desired username.
 - **Password:** Enter the desired password.
 - **Confirm Password:** Reenter the password for confirmation.
- **Encrypt:** Specifies encryption only and enables configuration of SSL authentication in the following text boxes:
 - **Username:** Enter the desired username.
 - **Password:** Enter the desired password.
 - **Confirm Password:** Reenter the password for confirmation.
- **OFF:** (Default setting) Specifies no SSL connection

Authentication Management

Authentication management can be configured for users and groups including Active Directory® credential management groups. Predefined access levels can also be assigned.

The following authentication management tabs are provided:

- Current User (refer to [Managing Current User Authentication](#) for information)
- Users (refer to [Managing User Authentication](#) for information)
- Groups (refer to [Managing Group Authentication](#) for information)

Managing Current User Authentication

By default, the **Current User** tab is displayed when the **Security** tab opens. The **Current User** tab enables information about the current user to be viewed. In addition, the user password can be changed if necessary.

Security Tab, Current User Tab

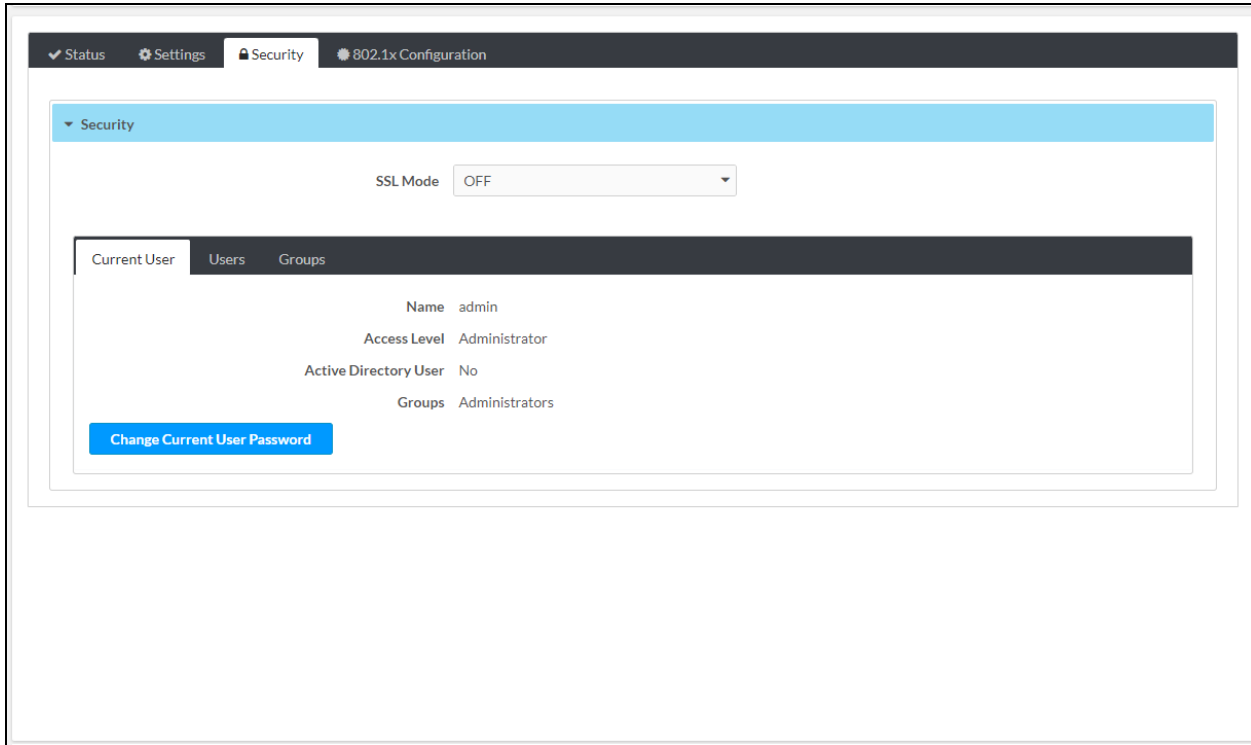

The **Current User** tab displays the following information:

- **Name:** Indicates the username
- **Access Level:** Indicates the access level of the current user: **Administrator, Programmer, Operator, User, or Connect**
- **Active Directory User:** Indicates whether the current user is authenticated using Active Directory credential management: **Yes** or **No**
- **Groups:** Indicates the groups to which the current user is a member

To change the password of the current user, select the **Change Current User Password** button. The **Change Password** pop-up dialog box opens.

Change Password Pop-Up Dialog Box

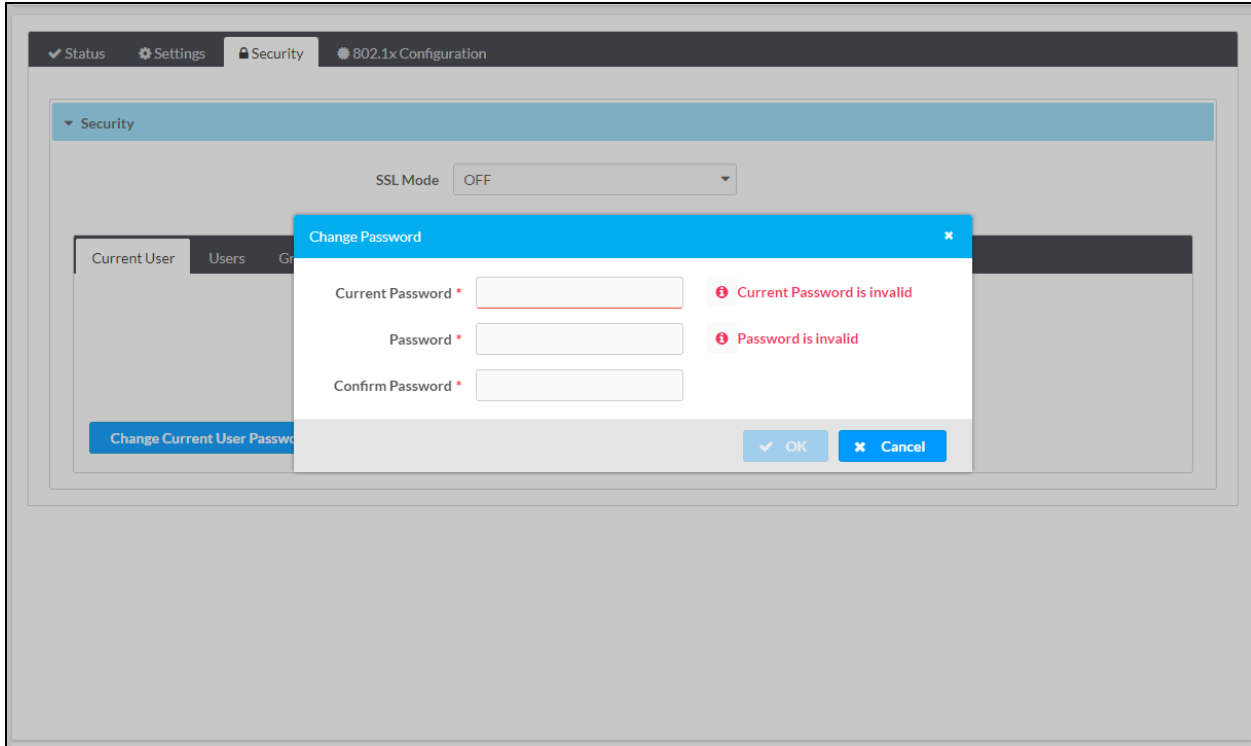

Enter the following information into the corresponding text boxes:

- **Current Password:** Enter the current password.
- **Password:** Enter a new password using a minimum of 8 characters. The password is case sensitive.
- **Confirm Password:** Reenter the new password for confirmation.

Select **OK** to save the new password and close the dialog box.

Managing User Authentication

Select the **Users** tab to view information about all users, to update user information, to delete a user, or to add a user.

Security Tab, Users Tab

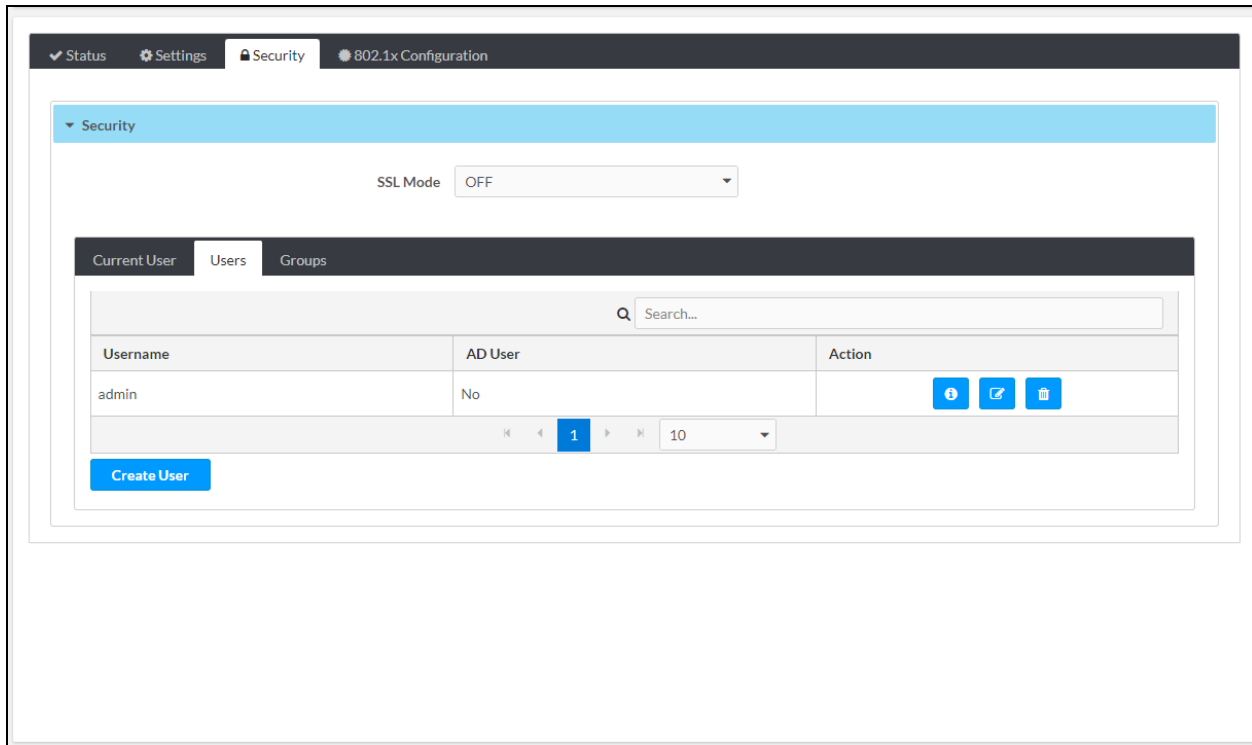

The **Users** tab provides a table that displays the following information about each user:

- **Username:** Indicates the username
- **AD User:** Indicates whether the user is authenticated using Active Directory credential management: **Yes** or **No**

By default, up to 10 users can be displayed in the table simultaneously. To change the default setting, select the desired number in the drop-down list at the bottom of the table. The number of users can be set to **5**, **10** (default setting), or **20**. If the number of users exceeds the number to be displayed simultaneously, do either of the following to locate additional users:

- Use the Search box above the table.
- Use the scroll arrows at the bottom of the table to navigate through the list of users.

The **Action** column of the Users table enables the following actions to be performed:

- [View user details](#)
- [Update user information](#)
- [Delete a user](#)

To add a user, refer to [Create a User](#) for information.

View User Details

In the **Action** column of the Users table, select the Information icon (i) to view details about a particular user listed in the table. The **User Details** pop-up dialog box opens.

Security Tab, Users Tab - User Details Pop-Up Dialog Box

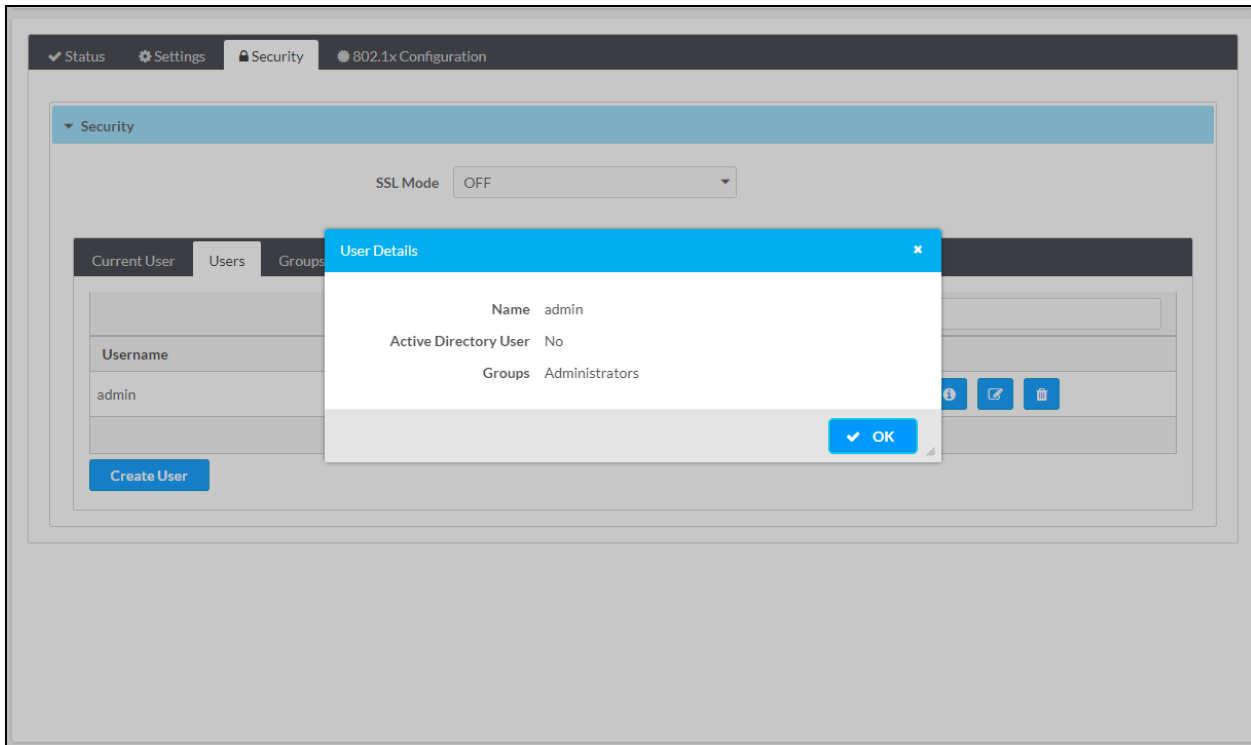

The **User Details** pop-up dialog box displays the following information:

- **Name:** Indicates the username
- **Active Directory User:** Indicates whether the user is authenticated using Active Directory credential management: **Yes** or **No**
- **Groups:** Indicates the groups to which the user is a member

Select **OK** to close the dialog box.

Update User Information

In the **Action** column of the **Users** table, select the Edit icon (✎) to update information about a particular user listed in the table. The **Update User** pop-up dialog box opens.

Security Tab, Users Tab - Update User Pop-Up Dialog Box

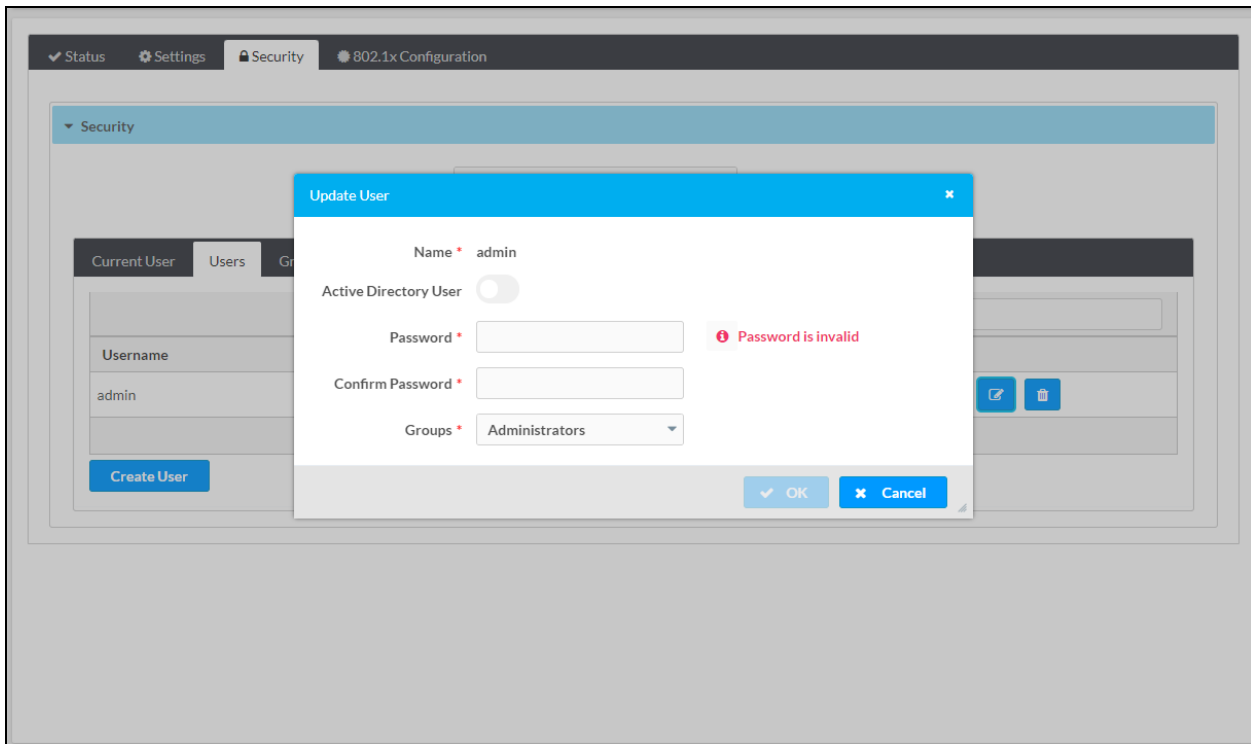

The **Update User** pop-up dialog box displays the username and whether Active Directory credential management is enabled for the user.

Update user information in the corresponding text boxes as follows:

- **Password:** (Applicable when **Active Directory User** credential management is disabled) Enter a new password.
- **Confirm Password:** (Applicable when **Active Directory User** credential management is disabled) Reenter the new password for confirmation.
- **Groups:** In the drop-down list, select one or more groups to which the user is to be a member. Available selections are as follows: **Select All**, **Administrators**, **Connects**, **Operators**, **Programmers**, and **Users**. The list of groups also includes any groups created in the **Groups** tab (refer to [Create a Group](#) for information). Selecting **Select All** selects all groups. To search for a group, enter the name of the group in the search box, and then select the checkbox for the desired group.

To save the changes, select **OK**. The dialog box closes.

Delete a User

In the **Action** column of the **Users** table, select the Trash icon (🗑️) to delete a user listed in the table. The **Delete Users** pop-up dialog box opens, prompting for confirmation that the user be deleted.

Security Tab, Users Tab - Delete Users Pop-Up Dialog Box

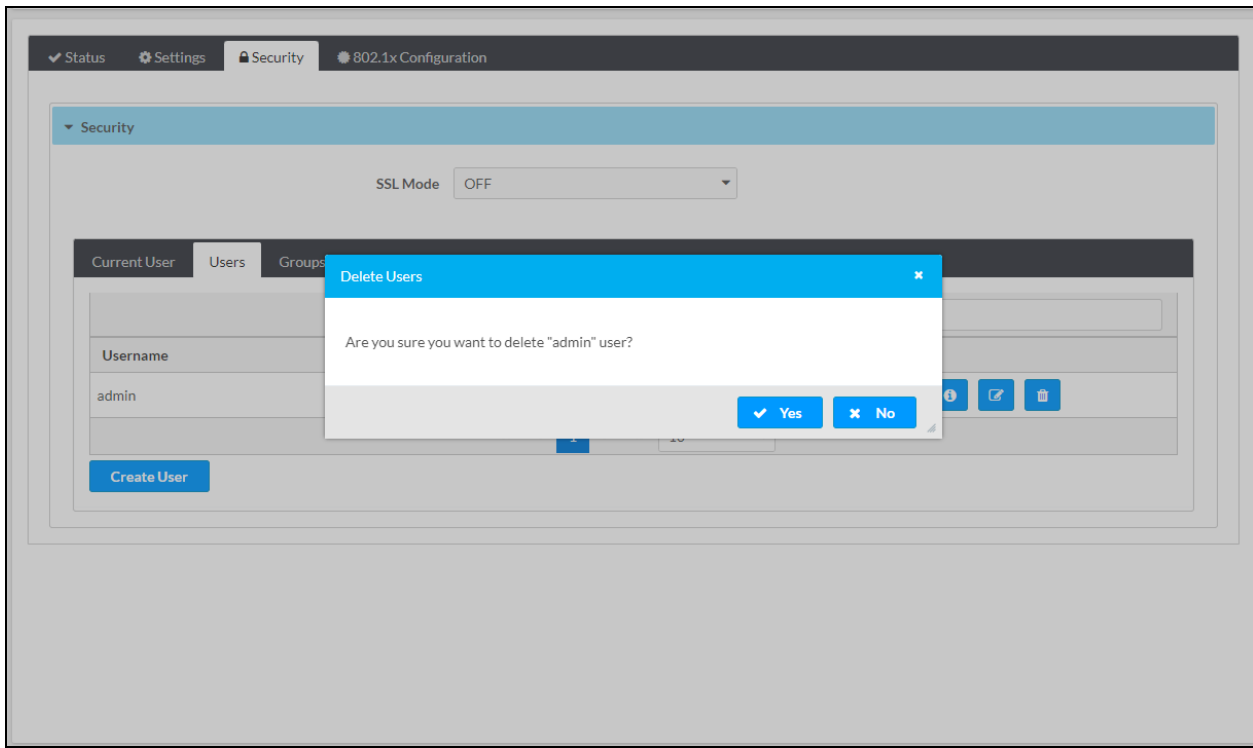

To delete the user, select **Yes**. The dialog box closes.

Create a User

In the **Users** tab, select the **Create User** button to add a user. The **Create User** pop-up dialog box opens.

Security Tab, Users Tab - Create User Pop-Up Dialog Box

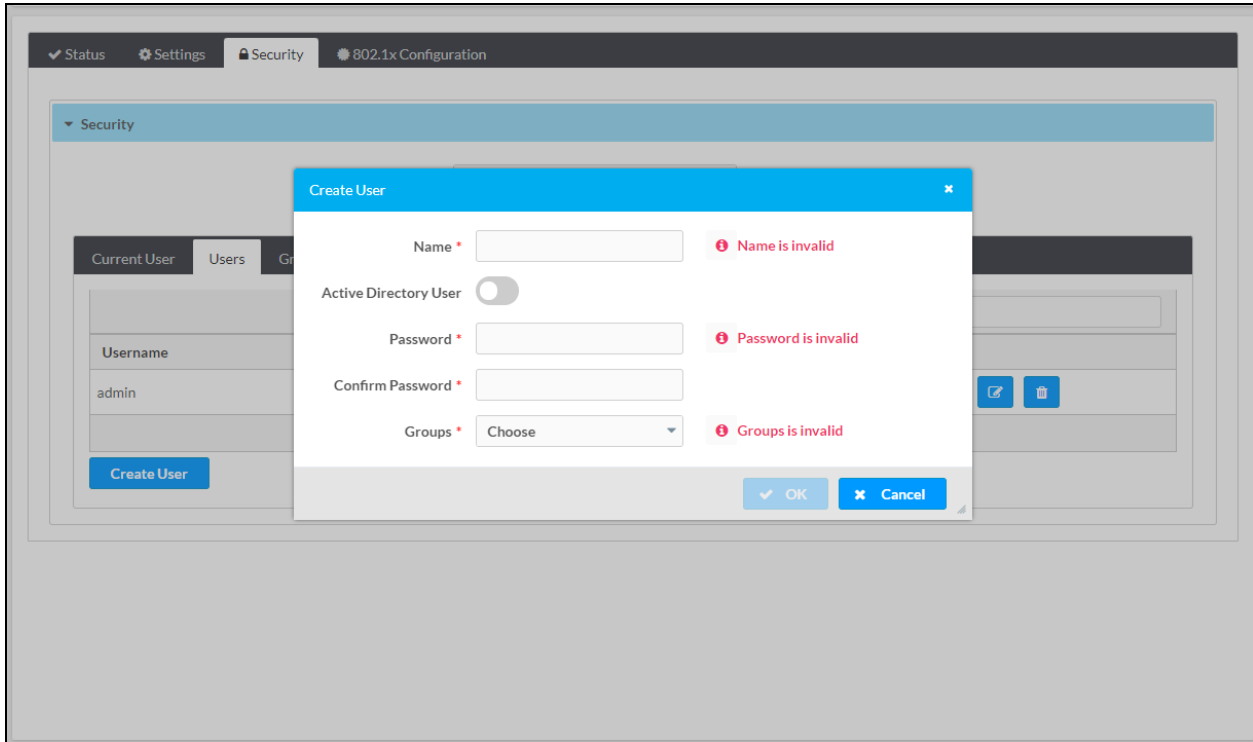

Create a user as follows:

- **Name:** Enter the username.
- **Active Directory User:** By default, **Active Directory User** credential management is disabled (the toggle switch is set in the Off position). To enable **Active Directory User**, set the toggle switch in the On position.
- **Password:** (Applicable when **Active Directory User** credential management is disabled) Enter a password for the user.
- **Confirm Password:** (Applicable when **Active Directory User** credential management is disabled) Reenter the password for confirmation.
- **Groups:** In the drop-down list, select one or more groups to which the user is to be a member. Default selections are as follows: **Select All, Administrators, Connects, Operators, Programmers, and Users**. The list of groups also includes any groups created in the Groups tab (refer to [Create a Group](#) for information). Selecting **Select All** selects all groups. To search for a group, enter the name of the group in the search box, and then select the checkbox for the desired group.

To save the changes, select **OK**. The dialog box closes.

Managing Group Authentication

Groups are used to group users based on access level and Active Directory credential management settings. Select the **Groups** tab to view information about all groups, to delete a group, or to add a group.

Security Tab, Groups Tab

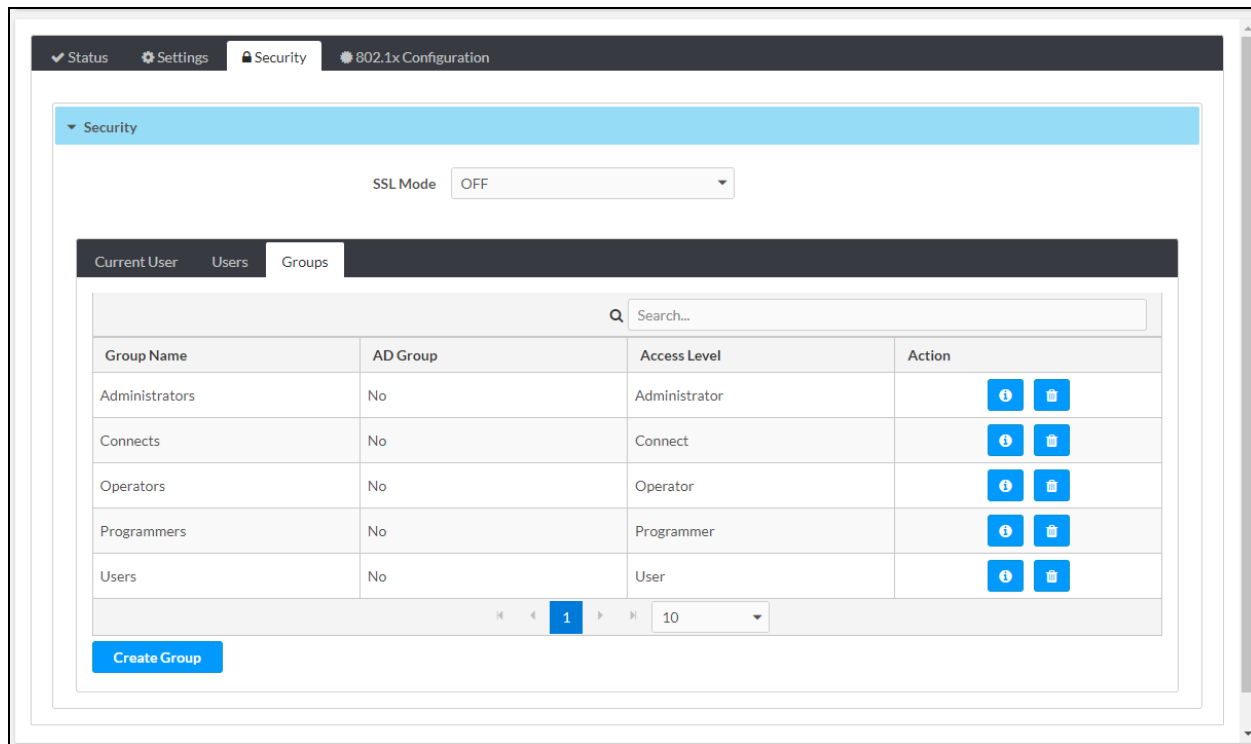

The **Groups** tab provides a table that displays the following information about each group:

- **Group Name:** Indicates the name of the group. Default group names are **Administrators**, **Connects**, **Operators**, **Programmers**, and **Users**.
- **AD Group:** Indicates whether the group is authenticated using Active Directory credential management: **Yes** or **No**
- **Access Level:** Indicates the access level of the group: **Administrator**, **Connect**, **Operator**, **Programmer**, or **User**.

By default, up to 10 groups can be displayed in the table simultaneously. To change the default setting, select the desired number in the drop-down list at the bottom of the table. The number of groups can be set to **5**, **10** (default setting), or **20**. If the number of groups exceeds the number to be displayed simultaneously, do either of the following to locate additional groups:

- Use the Search box above the table.
- Use the scroll arrows at the bottom of the table to navigate through the list of groups.

The **Action** column of the Groups table enables the following actions to be performed:

- [View group details](#)
- [Delete a group](#)

To add a group, refer to [Create a Group](#) for information.

View Group Details

In the **Action** column of the Groups table, select the Information icon (i) to view details about a particular group listed in the table. The **Group Details** pop-up dialog box opens.

Security Tab, Groups Tab - Group Details Pop-Up Dialog Box

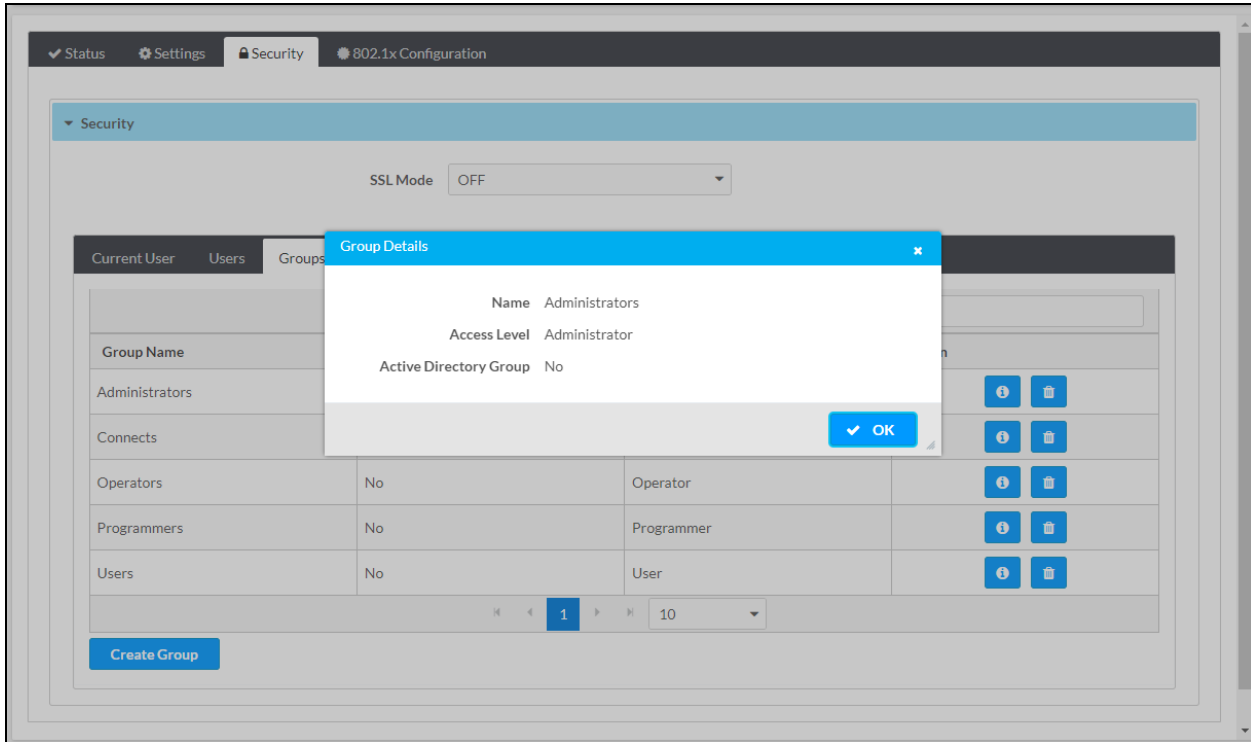

The **Group Details** pop-up dialog box displays the following information:

- **Name:** Indicates the name of the group
- **Access Level:** Indicates the access level of the group
- **Active Directory Group:** Indicates whether the group is authenticated using Active Directory credential management: **Yes** or **No**

Select **OK** to close the dialog box.

Delete a Group

In the **Action** column of the **Groups** table, select the Trash icon (🗑️) to delete a group listed in the table. The **Delete Groups** pop-up dialog box opens, prompting for confirmation that the group be deleted.

Security Tab, Groups Tab - Delete Groups Pop-Up Dialog Box

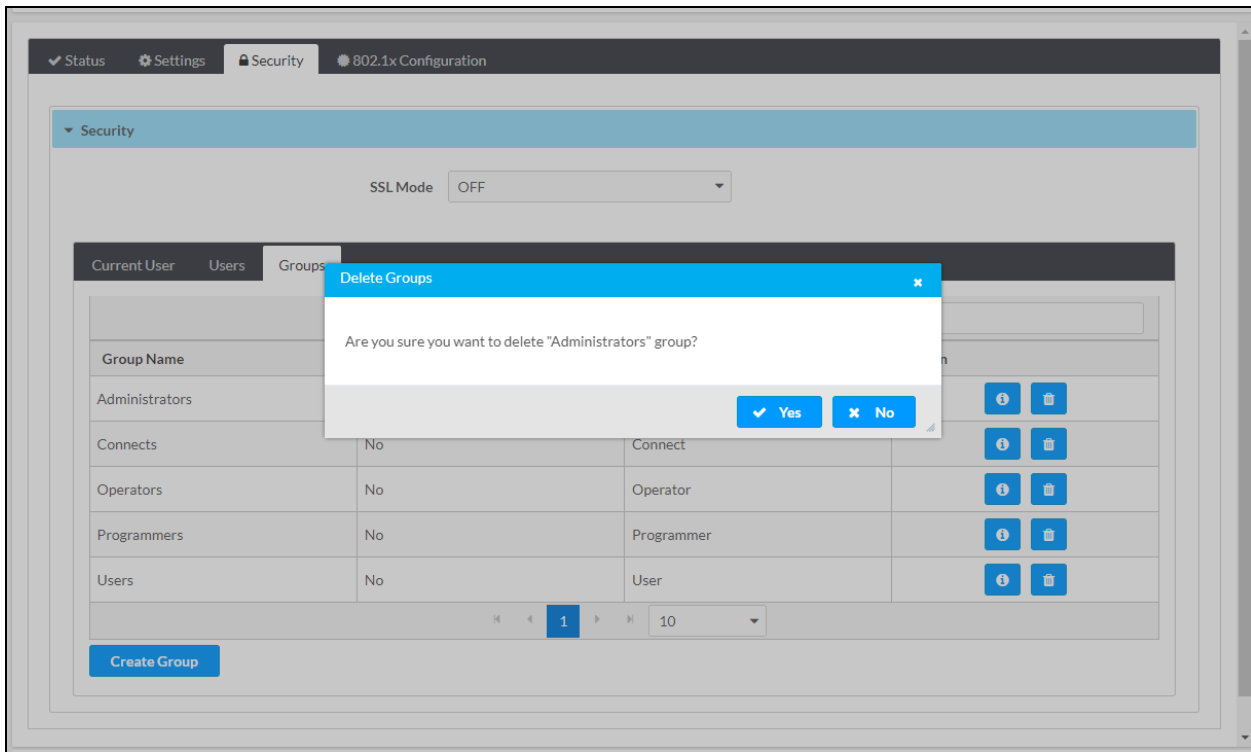

To delete the group, select **Yes**. The dialog box closes.

Create a Group

In the **Groups** tab, select the **Create Group** button to add a group. The **Create Group** pop-up dialog box opens.

Security Tab, Groups Tab - Create Group Pop-Up Dialog Box

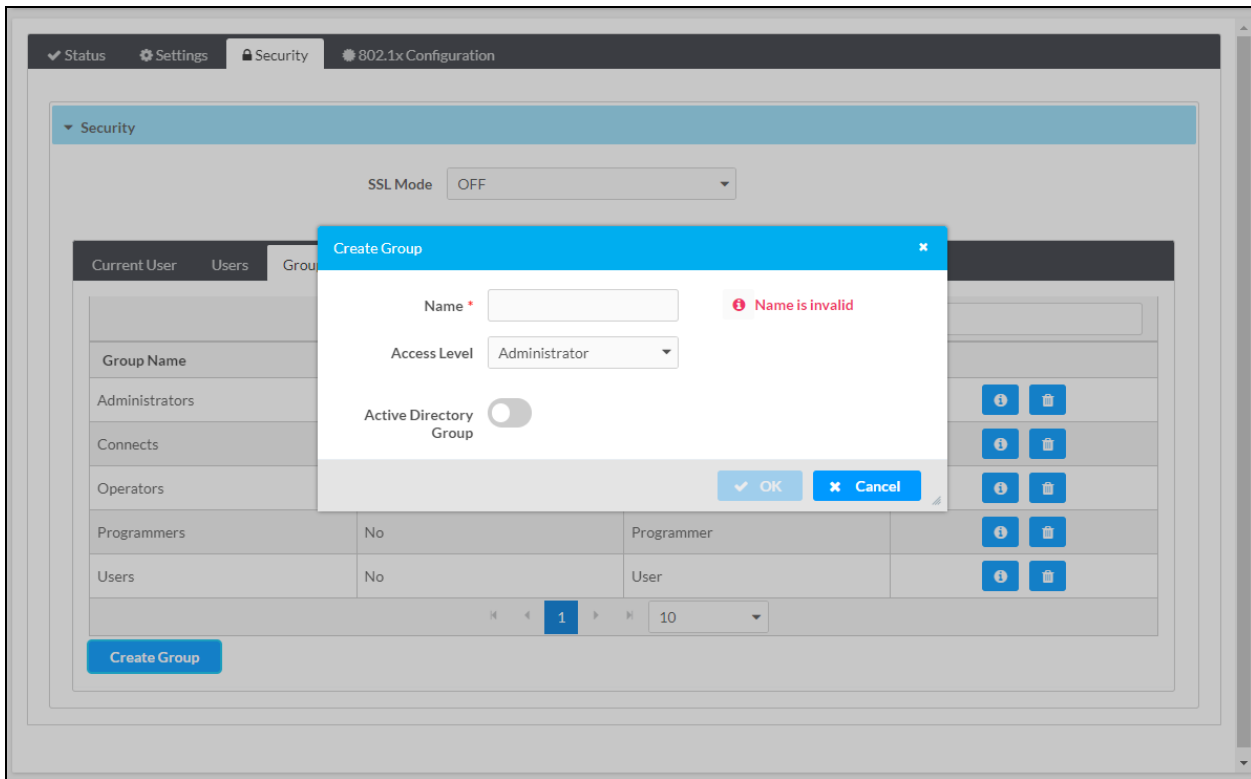

Add a group as follows:

- **Name:** Enter the name of the group.
- **Access Level:** In the drop-down list, select one of the following access levels: **Administrator**, **Connect**, **Operator**, **Programmer**, or **User**.
- **Active Directory Group:** By default, **Active Directory Group** is disabled (the toggle switch is set in the Off position). To enable **Active Directory Group**, set the toggle switch in the On position.

To save the changes, select **OK**. The dialog box closes.

Configuring IEEE 802.1X Settings

NOTE: If required, add trusted root certificates prior to selection of certificates in the **802.1x Configuration** tab. To do so, refer to [Managing Certificates](#) for information.

Select the **802.1x Configuration** tab to configure IEEE 802.1X network authentication.

802.1x Configuration Tab

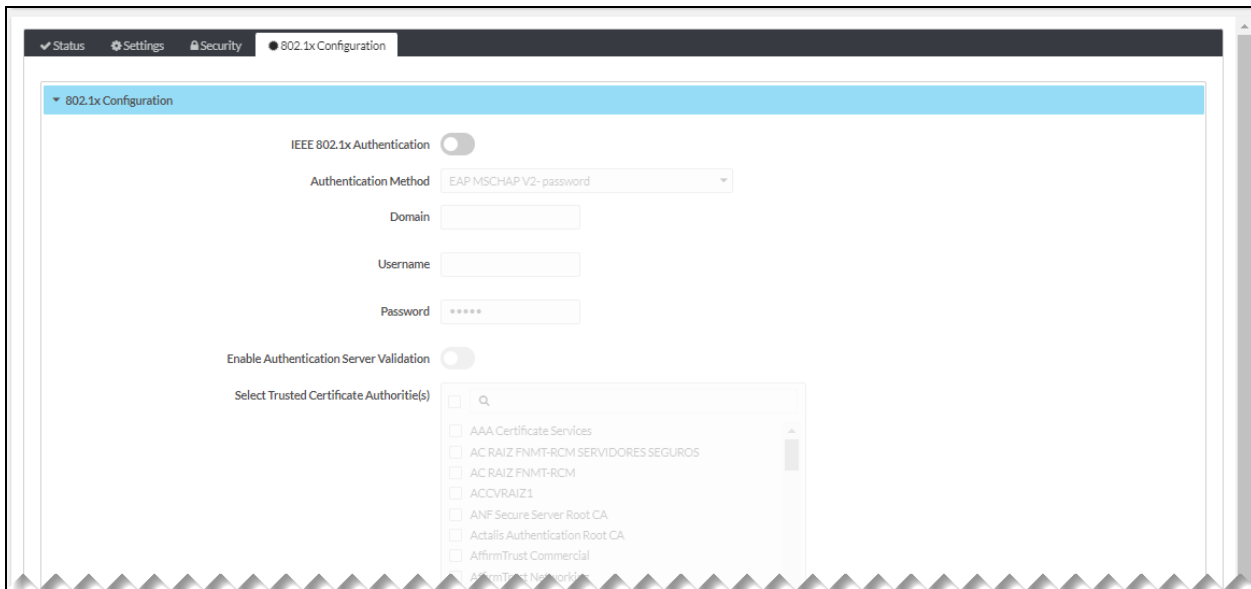

Refer to the configuration guidelines that follow.

IEEE 802.1x Authentication: By default, IEEE 802.1X authentication is disabled (the toggle switch is set in the Off position) and cannot be configured.

To enable IEEE 802.1X authentication, set the toggle switch in the On position and configure the following parameters:

- **Authentication Method:** In the drop-down list, select one of the following as required by the network administrator: **EAP MSCHAP V2-password** or **EAP-TLS Certificate**. The default setting is **EAP MSCHAP V2-password**.

Configure the following:

- **Domain:** (Optional, applicable only when **EAP MSCHAP V2-password** is selected as the authentication method) Enter the domain name that is to be used for authentication.
- **Username:** (Required, applicable only when **EAP MSCHAP V2-password** is selected as the authentication method) Enter the username that is to be used for authentication.
- **Password:** (Required, applicable only when **EAP MSCHAP V2-password** is selected as the authentication method) Enter the password that is to be used for authentication.

- **Enable Authentication Server Validation:** By default, **Enable Authentication Server Validation** is disabled (the toggle switch is set in the Off position). To enable server validation for increased security, set the toggle switch in the On position.
- **Select Trusted Certificate Authoritie(s):** (Applicable when **Enable Authentication Server Validation** is enabled)

NOTE: The DM Essentials device provides a list of preloaded trusted root certificates from the Trusted Root Certification Authorities (CAs) certificate store. If required, additional root certificates can be uploaded to the DM Essentials device (refer to [Managing Root Certificates](#) for information).

In the CA selection box, select one or more trusted CAs as follows:

- To select all CAs simultaneously, select the checkbox to the left of the search box.
- To select one or more CAs on an individual basis, do either of the following:
 - Scroll for the desired CAs and select the corresponding checkboxes.
 - Use the search box and select the checkboxes for the desired CAs.

Management

NOTE: This section applies to the HD-TXU-4KZ-211, HD-TXU-4KZ-211-CHGR, and HD-RXU-4KZ-202 only.

Management functions of the HD-TXU-4KZ-211(-CHGR) and HD-RXU-4KZ-202 include the following:

- [Rebooting the device](#)
- [Restoring factory default settings](#)
- [Updating firmware](#)
- [Downloading message logs](#)
- [Managing certificates](#)
- [Managing EDIDs](#)
- [Managing device drivers](#)
- [Downloading a configuration file](#)
- [Uploading a configuration file](#)
- [Managing an occupancy sensor](#)
- [Managing schedules](#)

Rebooting the Device

To reboot the device:

1. In the **Action** menu located in the upper-right corner of the web interface, select **Reboot**.

Action Menu - Reboot

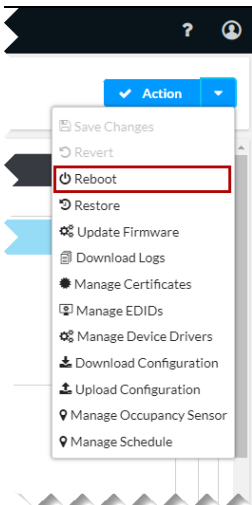

The **Reboot** pop-up dialog box opens, prompting for confirmation that the device be rebooted.

Reboot Pop-Up Dialog Box

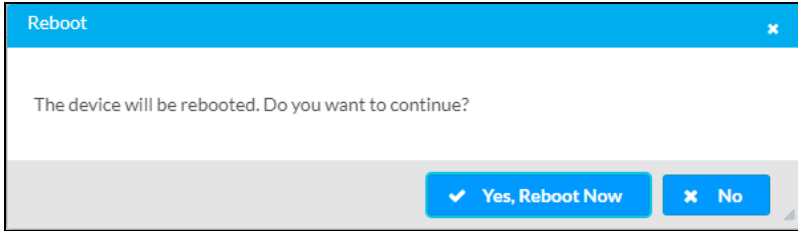

2. Select the **Yes, Reboot Now** button.

The **Reboot** message box opens, indicating that the device is rebooting. In addition, a progress indicator bar displays the percentage of completion of the reboot process. When the reboot process is complete, the progress indicator bar displays 100%.

Reboot Message Box

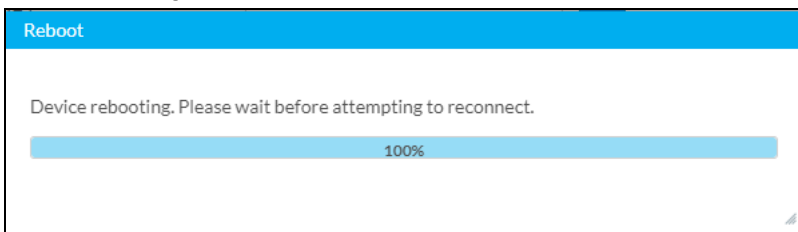

The Device Administration page opens, enabling sign-in to the device.

Restoring Factory Default Settings

This section provides information about restoring the device to factory default settings by using any of the following:

- [Web interface](#)
- [SETUP button](#)
- [Crestron Toolbox software](#)

Using the Web Interface

To restore the factory default settings by using the web interface:

1. In the **Action** menu located in the upper-right corner of the web interface, select **Restore**.

Action Menu - Restore

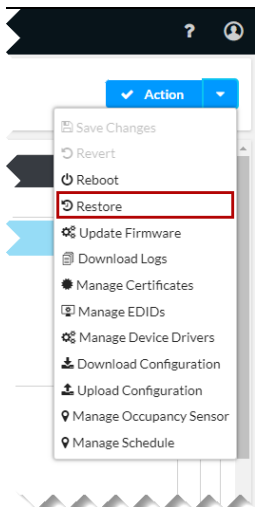

The **Restore** pop-up dialog box opens, prompting for confirmation that the device be restored to factory default settings.

Restore Pop-Up Dialog Box

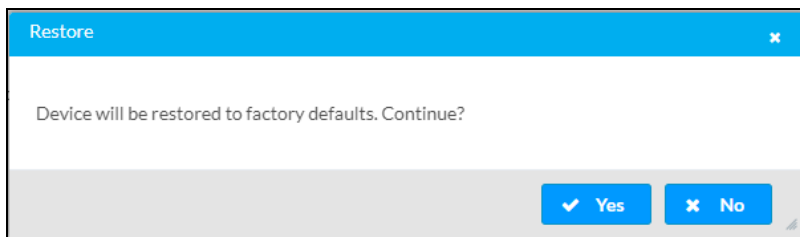

2. Select the **Yes** button to restore factory default settings.

The **Restore** message box opens, indicating that the device is being restored. In addition, a progress indicator bar displays the percentage of completion of the restore process. When the reboot process is complete, the progress indicator bar displays 100%.

Restore Message Box Indicating Restore Process

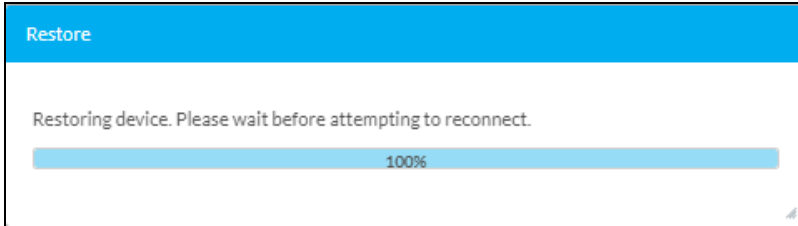

The **Restore** message box then indicates that the device was restored successfully.

Restore Message Box Indicating Successful Restore

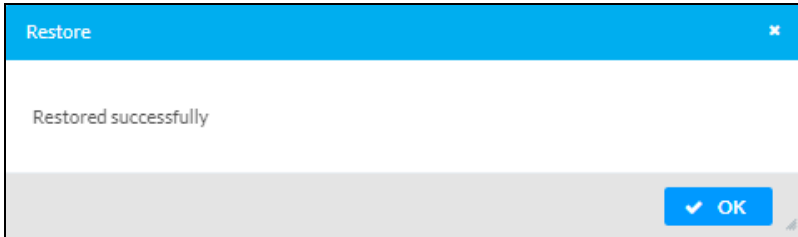

3. Select **OK** to close the message box. The Device Administration Page - Create User page opens. After a user account is created, the Device Administration page opens, enabling sign-in to the device.

Using the SETUP Button

To restore factory default settings by using the **SETUP** button on the device:

1. Remove power from the device.
2. Press and hold the **SETUP** button while applying power to the device. Wait until the **SETUP** LED begins flashing, and then release the **SETUP** button.

The device reboots automatically after the default settings are restored.

Using Crestron Toolbox Software

To restore the factory default settings by using Crestron Toolbox software:

From the **Tools** menu, select **Text Console** and issue the `restore` command.

Updating Firmware

The information below provides instructions for upgrading firmware manually. For instructions to update firmware automatically based on a scheduled period of time, refer to [Auto Update](#) in the [Configuration](#) section of this manual. To update firmware using the web interface:

NOTE: If an HD-TXU-4KZ-211 is connected to an HD-RXU-4KZ-202, initiating a firmware update on one device can update the firmware on both devices. Consider the following:

- The other device's LAN port must be disconnected.
- Updating both devices in this way will take approximately 70 minutes. A session timeout error may be seen before the upgrade is complete.
- To achieve faster upgrade times, upgrade each device independently through its own LAN connection and web interface.

1. Download the latest firmware file (*.puf) from www.crestron.com/firmware to a computer.
2. In the **Action** menu located in the upper-right corner of the web interface, select **Update Firmware**.

Action Menu - Update Firmware

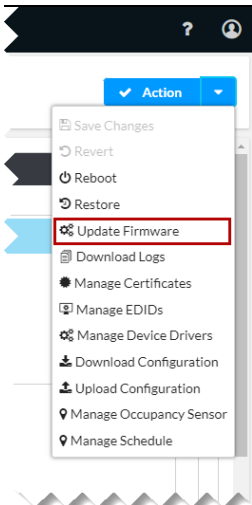

The **Update Firmware - Browse** pop-up dialog box opens.

Update Firmware - Browse Pop-Up Dialog Box

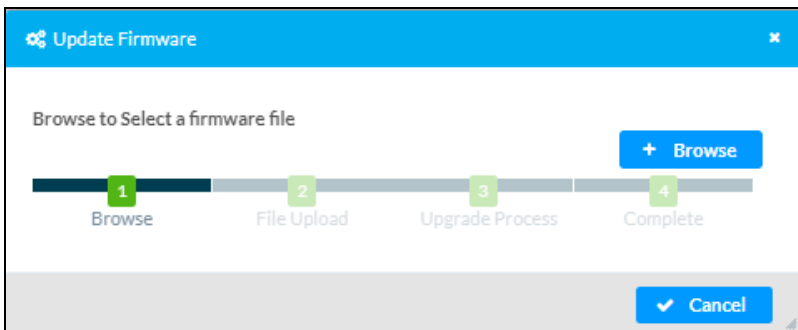

3. Select **Browse**. File Explorer opens.
4. Navigate to the latest firmware file (*.puf), select the file, and then select **Open**.
The **Update Firmware - File Upload** dialog box opens.

Update Firmware - File Upload Dialog Box

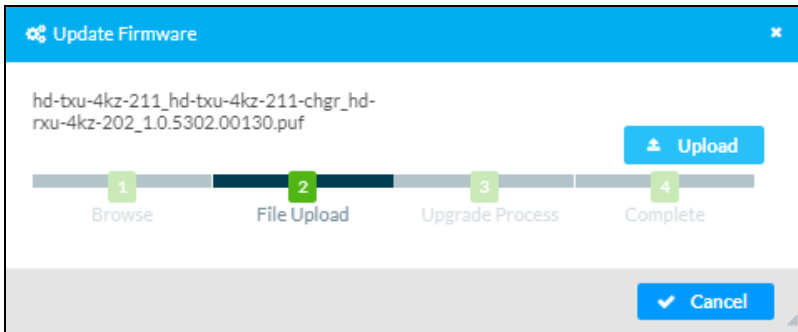

5. Select **Upload**.

The **Update Firmware** dialog box indicates the progress of the upload and update process. When the update process is complete, the **Update Firmware - Complete** dialog box opens, indicating the successful completion of the update process.

Update Firmware - Complete Dialog Box

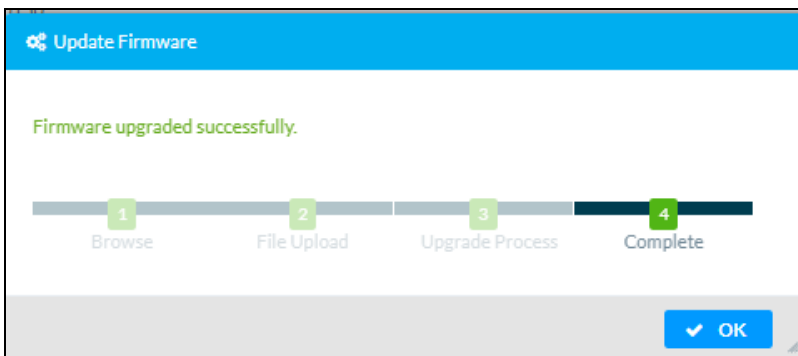

6. Select **OK**.

The Status page opens, displaying the latest firmware version.

Downloading Message Logs

Message logs can be downloaded to a computer for diagnostic purposes.

To download message logs:

In the **Action** menu located in the upper-right corner of the web interface, select **Download Logs**.

Action Menu - Download Logs

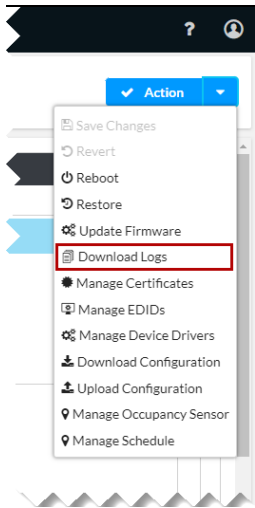

The **Loading** message appears indicating that the message logs are being downloaded. When the process is complete, the message logs are downloaded in a compressed .tgz file. To view the message logs, extract them from the .tgz file.

Managing Certificates

To manage root, intermediate, machine, and web server certificates:

In the **Action** menu located in the upper-right corner of the web interface, select **Manage Certificates** to view information about certificates that reside on the device or to add or delete certificates.

Action Menu - Manage Certificates

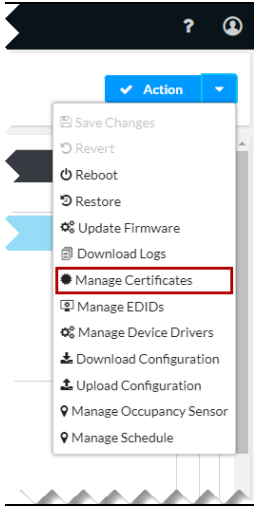

The **Manage Certificates** pop-up dialog box opens.

Manage Certificates Pop-Up Dialog Box

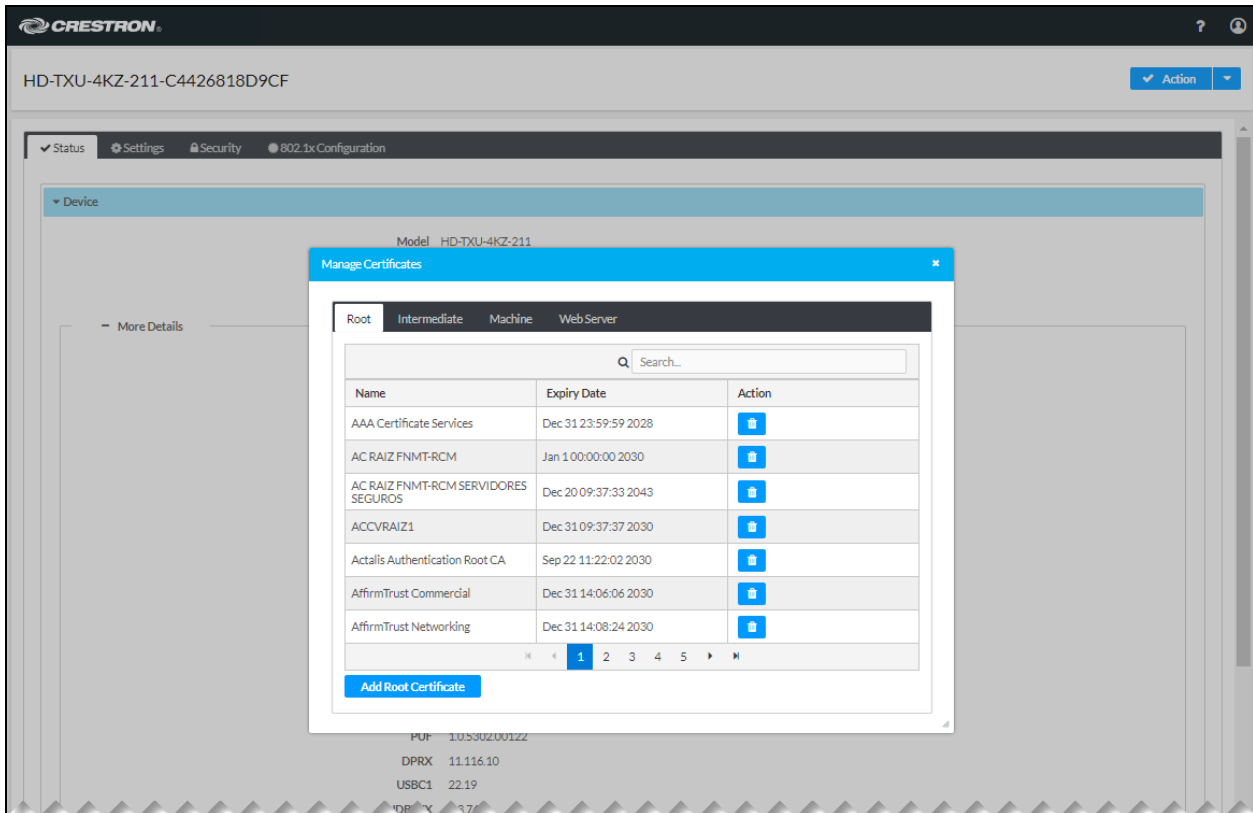

The **Manage Certificates** pop-up dialog box provides the following tabs based on certificate categories:

- **Root:** The Root tab lists all trusted root certificates preloaded into the device. The root certificates are used by the device to verify server certificates when acting as a TLS client. Root certificates are the beginning of a certificate chain. The Issuer and Subject fields of a root certificate are the same. The device can use an alternate list of trusted certificates for certain protocols or use cases; however, unless specifically indicated, the Root store is used. To add or delete root certificates, refer to [Managing Root Certificates](#).
- **Intermediate:** The Intermediate category of trusted certificates is identical to the Root category of trusted certificates except that the Intermediate store contains only intermediate certificates, which were signed by another certificate—the Issuer and Subject fields of the intermediate certificate are not the same. To add or delete intermediate certificates, refer to [Managing Intermediate Certificates](#).
- **Machine:** The Machine category contains a single client certificate that is used only for IEEE 802.1X when **EAP-TLS Certificate** is selected as the authentication method in the **801.2x Configuration** tab of the web interface. The certificate must include a private key. To add or delete a machine certificate, refer to [Managing Machine Certificates](#).
- **Web Server:** The Web Server category contains a single server certificate that is used by the web server. The web server certificate must include a private key. If no web server certificate is loaded, the default server certificate will be used. To add or delete a web server certificate, refer to [Managing Web Server Certificates](#).

Managing Root Certificates







In the **Manage Certificates** pop-up dialog box, select the **Root** tab to view information about root certificates that reside on the device or to add or delete root certificates. By default, the **Root** tab is displayed when the dialog box opens.

Manage Certificates Pop-Up Dialog Box - Root Tab

Manage Certificates ✕

Root Intermediate Machine Web Server

Search...

Name	Expiry Date	Action
AAA Certificate Services	Dec 31 23:59:59 2028	
AC RAIZ FNMT-RCM	Jan 1 00:00:00 2030	
AC RAIZ FNMT-RCM SERVIDORES SEGUROS	Dec 20 09:37:33 2043	
ACCVRAIZ1	Dec 31 09:37:37 2030	
Actalis Authentication Root CA	Sep 22 11:22:02 2030	
AffirmTrust Commercial	Dec 31 14:06:06 2030	
AffirmTrust Networking	Dec 31 14:08:24 2030	

« ‹ 1 2 3 4 5 › »

[Add Root Certificate](#)

The **Root** tab provides a table that displays the following information about root certificates:

- **Name:** Name of the certificate
- **Expiry Date:** Expiration date and time of the certificate

By default, up to seven certificates are displayed in the table simultaneously. If the number of certificates listed in the table exceeds seven, do either of the following to locate additional certificates:

- Use the Search box above the table.
- Use the scroll arrows at the bottom of the table to navigate through the list of certificates.

To manage root certificates, [add](#) or [delete](#) certificates as required.

Add a Root Certificate

To add a root certificate:

1. In the **Root** tab, select the **Add Root Certificate** button.
2. The **Add Certificate - Browse** pop-up dialog box opens.

Add Certificate - Browse Pop-Up Dialog Box

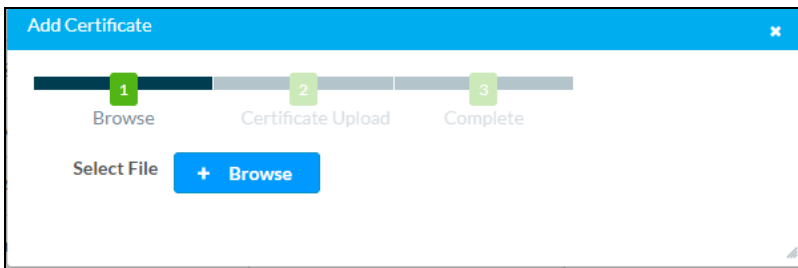

3. Select **Browse**. File Explorer opens.
4. Navigate to the desired certificate file, select the file, and then select **Open**.

The **Add Certificate - Certificate Upload** dialog box opens.

Add Certificate - Certificate Upload Dialog Box

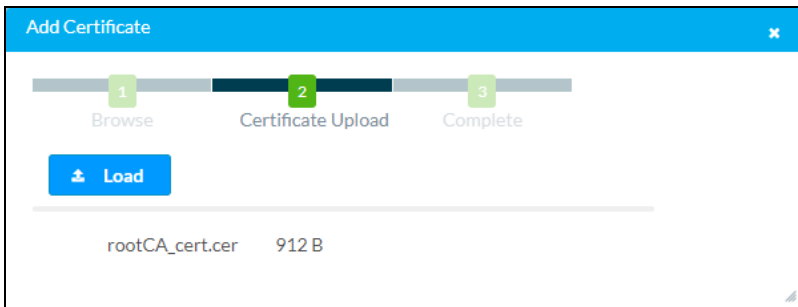

5. Select **Load**.

When the certificate upload process is complete, the **Certificate added successfully** message appears in the **Add Certificate - Complete** dialog box.

Add Certificate - Complete Dialog Box

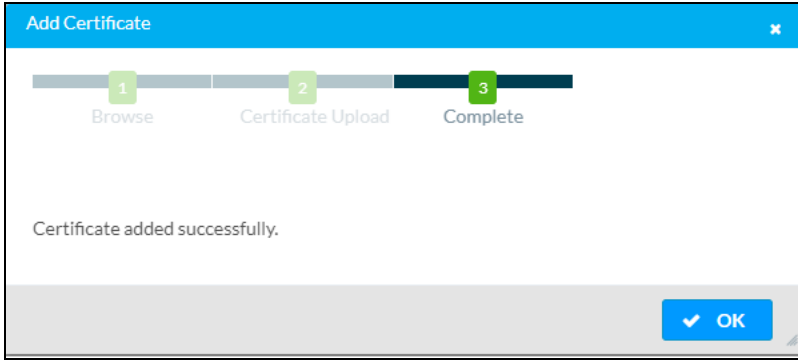

6. Select **OK** to close the dialog box.
The certificate is added to the root certificate table.
7. Close the **Manage Certificates** pop-up dialog box by selecting the **x** in the upper-right corner.

Delete a Root Certificate

To delete a root certificate:

1. In the **Action** column of the root certificate table, select the Trash icon (🗑️) corresponding to the certificate to be deleted.

The **Delete Certificate** pop-up dialog box opens, prompting for confirmation that the certificate be deleted.

Delete Certificate Pop-Up Dialog Box

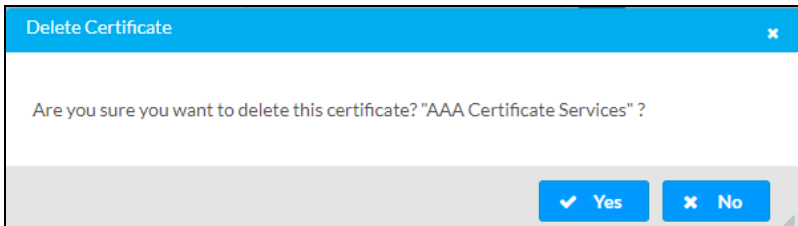

2. Select **Yes** to delete the certificate.
The certificate is removed from the root certificate table.
3. Close the **Manage Certificates** pop-up dialog box by selecting the **x** in the upper-right corner.

Managing Intermediate Certificates

In the **Manage Certificates** pop-up dialog box, select the **Intermediate** tab to view information about intermediate certificates that reside on the device or to add or delete intermediate certificates.

Manage Certificates Pop-Up Dialog Box - Intermediate Tab

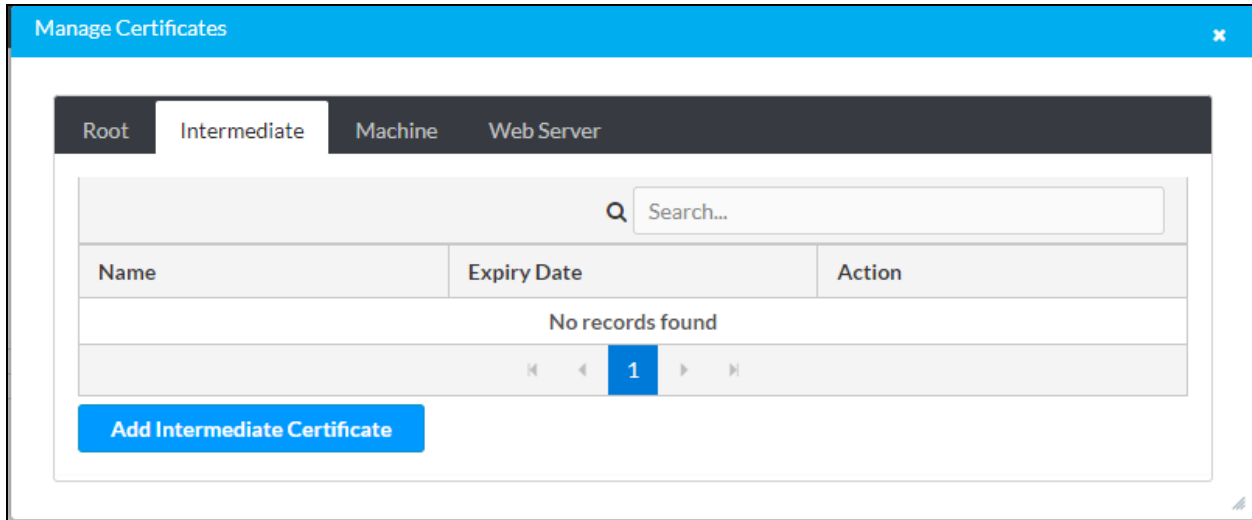

The **Intermediate** tab provides a table that displays the following information:

- **Name:** Name of the certificate
- **Expiry Date:** Expiration date and time of the certificate

By default, up to seven certificates can be displayed in the table simultaneously. If the number of certificates listed in the table exceeds seven, do either of the following to locate additional certificates:

- Use the Search box above the table.
- Use the scroll arrows at the bottom of the table to navigate through the list of certificates.

To manage intermediate certificates, [add](#) or [delete](#) certificates as required.

Add an Intermediate Certificate

To add an intermediate certificate:

1. In the **Intermediate** tab, select the **Add Intermediate Certificate** button. The **Add Certificate - Browse** pop-up dialog box opens.

Add Certificate - Browse Dialog Box

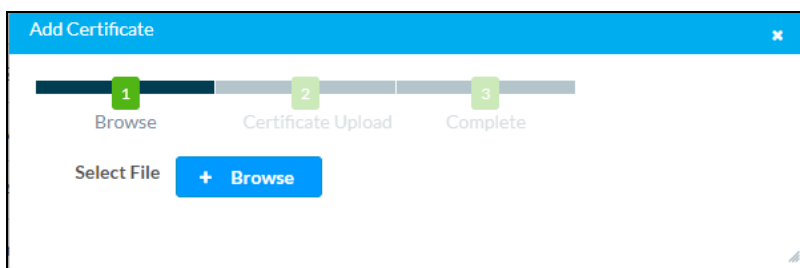

2. Select **Browse**. File Explorer opens.
3. Navigate to the desired certificate file, select the file, and then select **Open**.
The **Add Certificate - Certificate Upload** dialog box opens.

Add Certificate - Certificate Upload Dialog Box

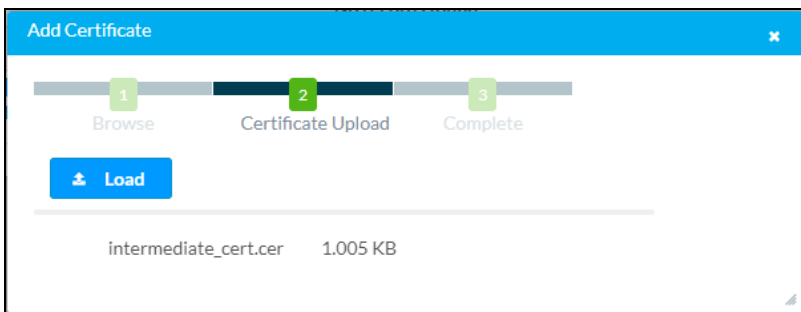

4. Select **Load**.
When the certificate upload process is complete, the **Certificate added successfully** message appears in the **Add Certificate - Complete** dialog box.

Add Certificate - Complete Dialog Box

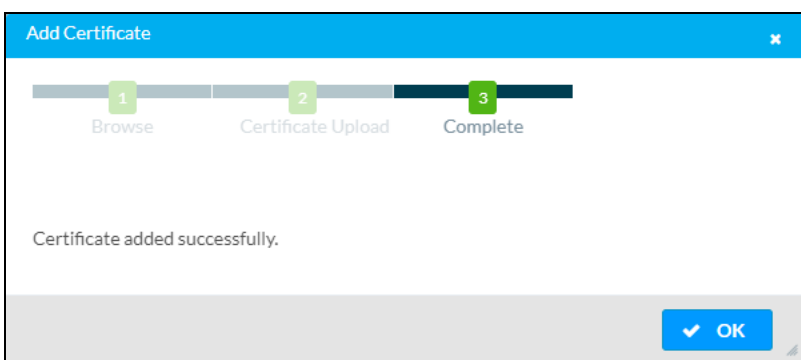

5. Select **OK** to close the dialog box.
The newly added certificate is listed in the intermediate certificate table as shown in the example below.

Addition of Intermediate Certificate

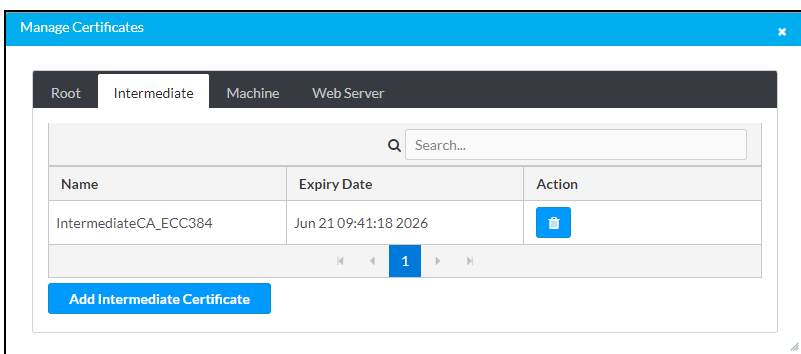

6. Close the **Manage Certificates** pop-up dialog box by selecting the **x** in the upper-right corner.

Delete an Intermediate Certificate

To delete an intermediate certificate:

1. In the **Action** column of the intermediate certificate table, select the Trash icon (🗑️) corresponding to the certificate to be deleted.

The **Delete Certificate** pop-up dialog box opens, prompting for confirmation that the certificate be deleted.

Delete Certificate Pop-Up Dialog Box

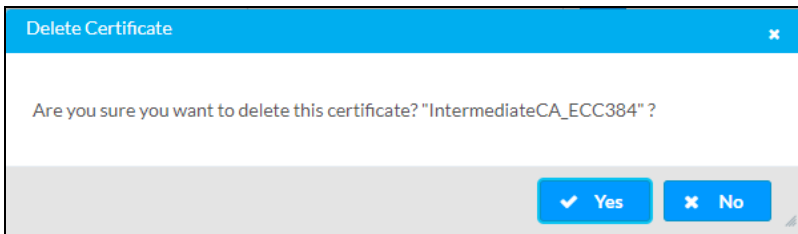

2. Select **Yes** to delete the certificate.
The certificate is removed from the intermediate certificate table.
3. Close the **Manage Certificates** dialog box by selecting the **x** in the upper-right corner.

Managing Machine Certificates

NOTE: Only one machine certificate can reside on the device.

In the **Manage Certificates** pop-up dialog box, select the **Machine** tab to view information about the machine certificate or to add or delete the certificate.

Manage Certificates Dialog Box - Machine Tab

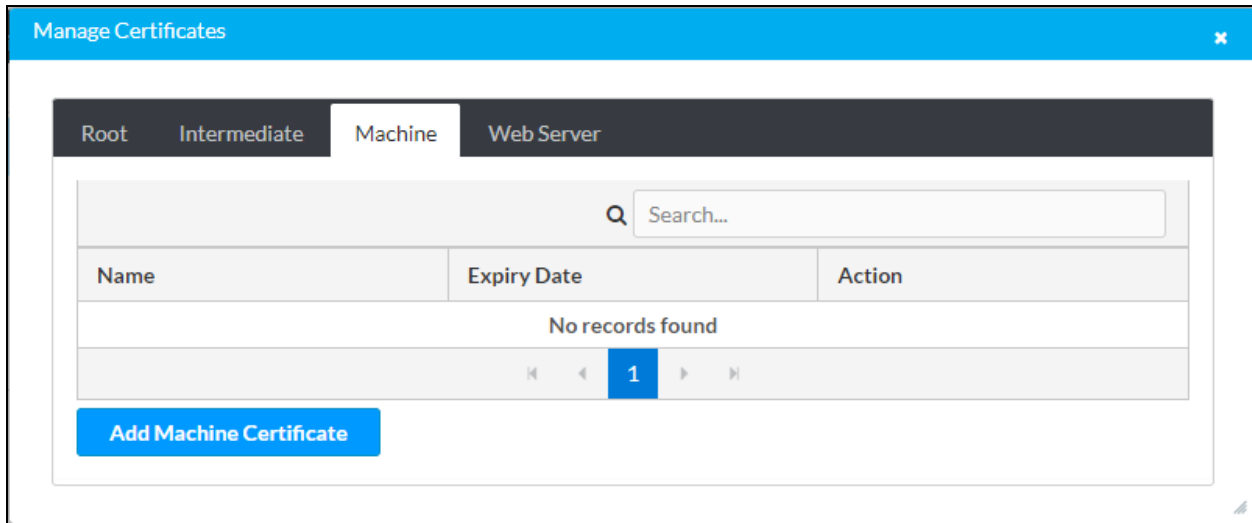

The **Machine** tab provides a table that displays the following information:

- **Name:** Name of the certificate
- **Expiry Date:** Expiration date and time of the certificate

To manage the machine certificate, [add](#) or [delete](#) the certificate as required.

Add the Machine Certificate

To add the machine certificate:

1. In the **Machine** tab, select the **Add Machine Certificate** button.

The **Add Certificate - Browse** pop-up dialog box opens.

Add Certificate - Browse Pop-Up Dialog Box

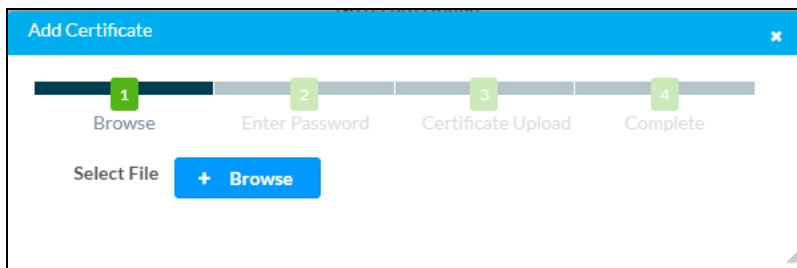

2. Select **Browse**. File Explorer opens.
3. Navigate to the desired certificate file, select the file, and then select **Open**.

The **Add Certificate - Enter Password** dialog box opens.

Add Certificate - Enter Password Dialog Box

machine_cert.pfx 2.581 KB

Password

Password cannot be less than 6 characters

Confirm Password

✓ OK

4. Do the following:
 - a. In the **Password** text box, enter a password. The password cannot be less than 6 characters.
 - b. In the **Confirm Password** text box, reenter the password for confirmation.
 - c. Select **OK** to save the password.

The **Add Certificate - Certificate Upload** dialog box opens.

Add Certificate - Certificate Upload Dialog Box

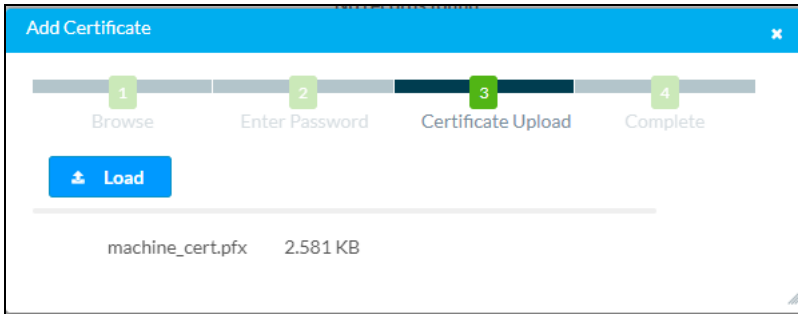

5. Select **Load**.

When the certificate upload process is complete, the **Certificate added successfully** message appears in the **Add Certificate - Complete** dialog box.

Add Certificate - Complete Dialog Box

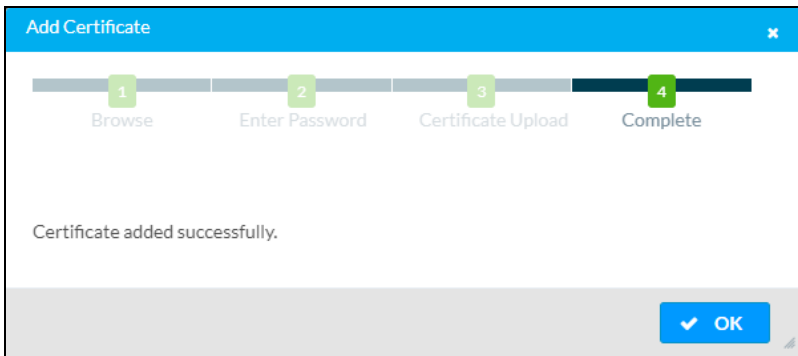

6. Select **OK** to close the dialog box.

The newly added certificate is listed in the machine certificate table as shown in the example below.

Addition of Machine Certificate

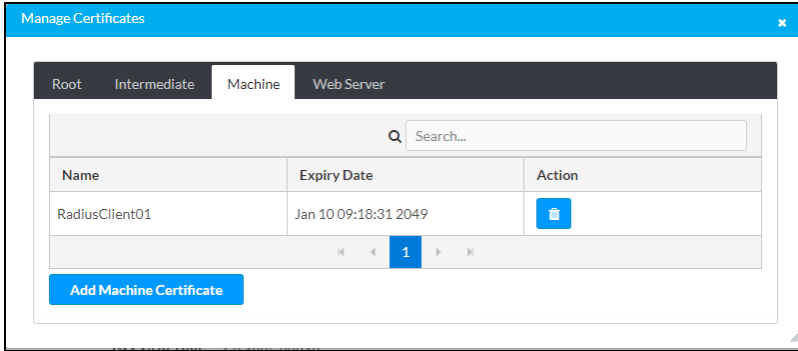

7. Close the **Manage Certificates** pop-up dialog box by selecting the **x** in the upper-right corner.

Delete the Machine Certificate

To delete the machine certificate:

1. In the **Action** column of the machine certificate table, select the Trash icon () corresponding to the certificate.

The **Delete Certificate** pop-up dialog box opens, prompting for confirmation that the certificate be deleted.

Delete Certificate Pop-Up Dialog Box

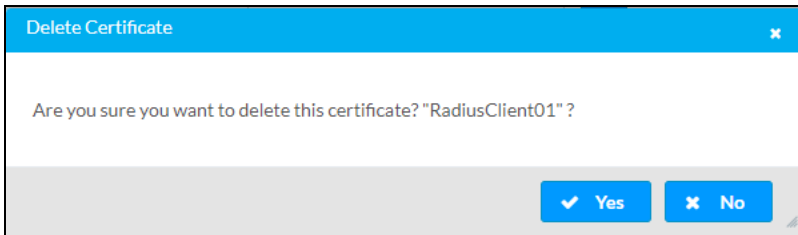

2. Select **Yes** to delete the certificate.
The certificate is removed from the machine certificate table.
3. Close the **Manage Certificates** dialog box by selecting the **x** in the upper-right corner.

Managing Web Server Certificates

NOTE: Only one web server certificate can reside on the DM Essentials device.

In the **Manage Certificates** pop-up dialog box, select the **Web Server** tab to view information about the web server certificate or to add or delete the certificate.

Manage Certificates Pop-Up Dialog Box - Web Server Tab

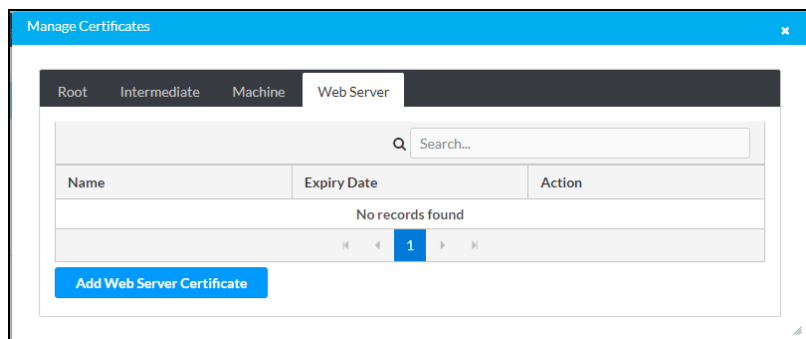

The **Web Server** tab provides a table that displays the following information:

- **Name:** Name of the certificate
- **Expiry Date:** Expiration date and time of the certificate

To manage the web server certificate, [add](#) or [delete](#) the certificate as required.

Add the Web Server Certificate

To add the web server certificate:

1. In the **Web Server** tab, select the **Add Web Server Certificate** button.
The **Add Certificate - Browse** pop-up dialog box opens.

Add Certificate - Browse Pop-Up Dialog Box

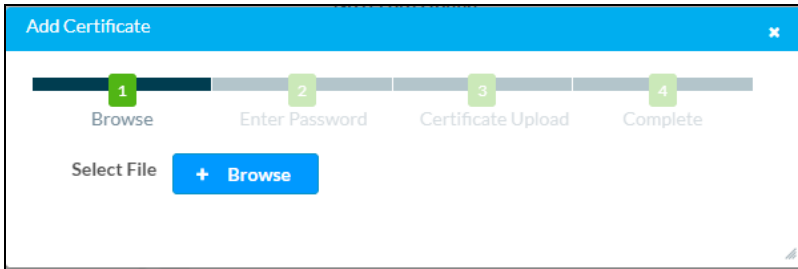

2. Select **Browse**. File Explorer opens.
3. Navigate to the desired certificate file, select the file, and then select **Open**.
The **Add Certificate - Enter Password** dialog box opens.

Add Certificate - Enter Password Dialog Box

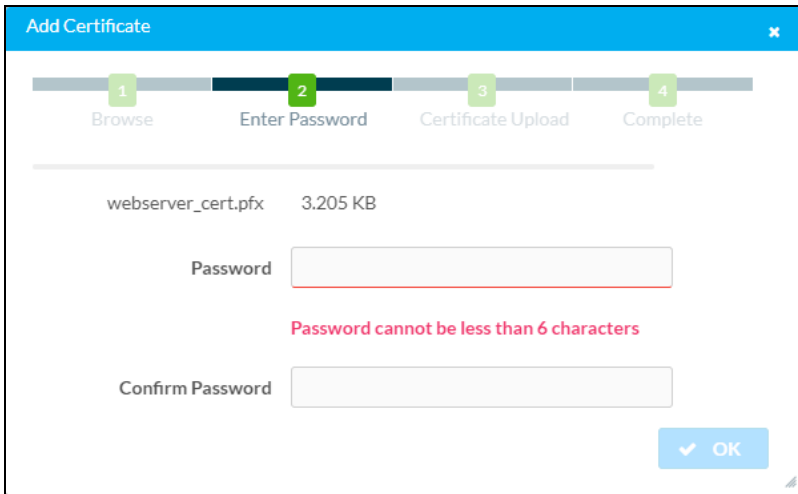

4. Do the following:
 - a. In the **Password** text box, enter a password. The password cannot be less than 6 characters.
 - b. In the **Confirm Password** text box, reenter the password for confirmation.
 - c. Select **OK** to save the password.

The **Add Certificate - Certificate Upload** dialog box opens.

Add Certificate - Certificate Upload Dialog Box

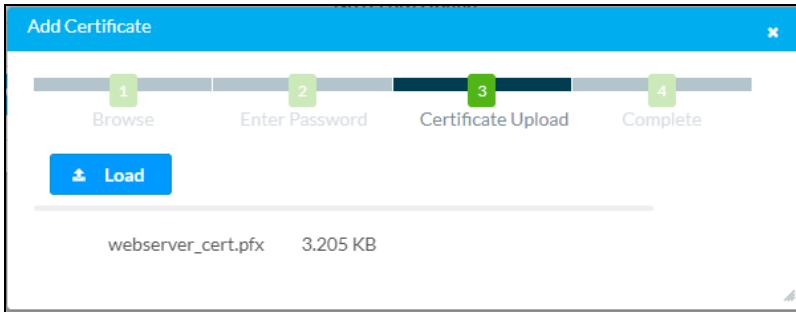

5. Select **Load**.

The certificate is uploaded to the device, and the **Reboot** dialog box opens, prompting for confirmation that the device be rebooted.

Reboot Dialog Box

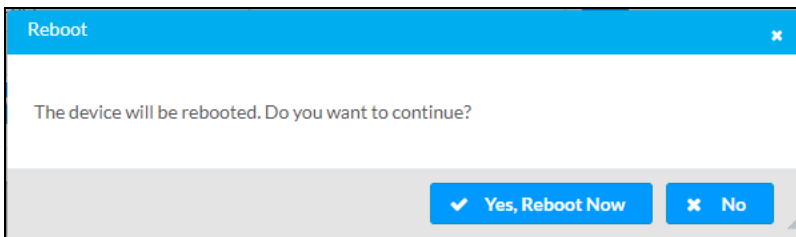

6. Select **Yes, Reboot Now** to reboot the device at the current time or select **No** to reboot the device at a later time.

If **Yes, Reboot Now** is selected, the **Reboot** message box appears, indicating that the device is rebooting. In addition, a progress indicator bar displays the percentage of completion of the reboot process. When the reboot process is complete, the progress indicator bar displays 100%.

Reboot Message Box

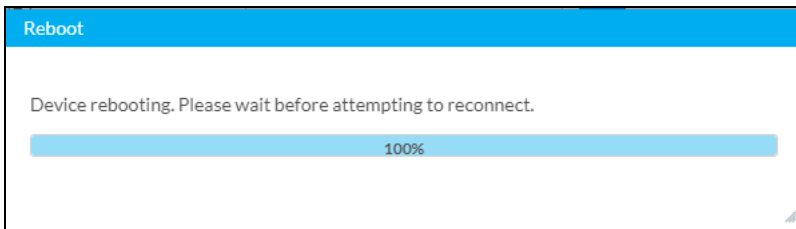

The Device Administration page opens, enabling sign-in to the device.

The newly added web server certificate is listed in the web server certificate table as shown in the example below.

Addition of Web Server Certificate

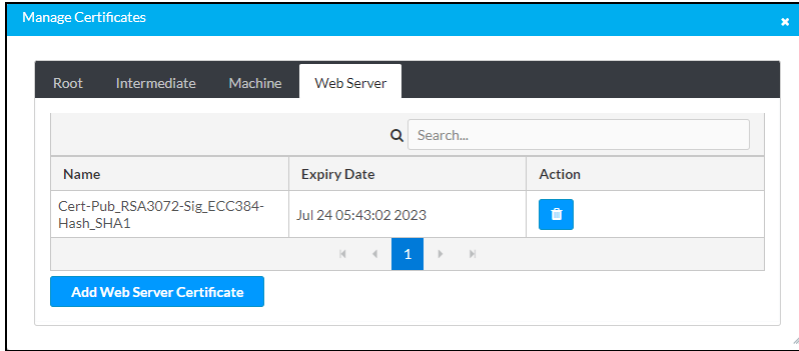

Delete the Web Server Certificate

To delete the web server certificate:

1. In the **Action** column of the web server certificate table, select the Trash icon () corresponding to the certificate.

The **Delete Certificate** pop-up dialog box opens, prompting for confirmation that the certificate be deleted.

Delete Certificate Pop-Up Dialog Box

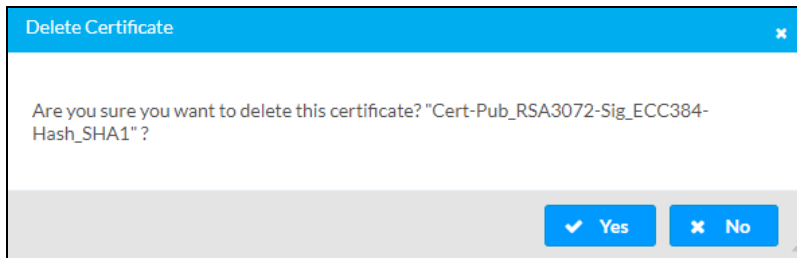

2. Select **Yes** to delete the certificate.

The **Reboot** dialog box opens, prompting for confirmation that the device be rebooted.

Reboot Dialog Box

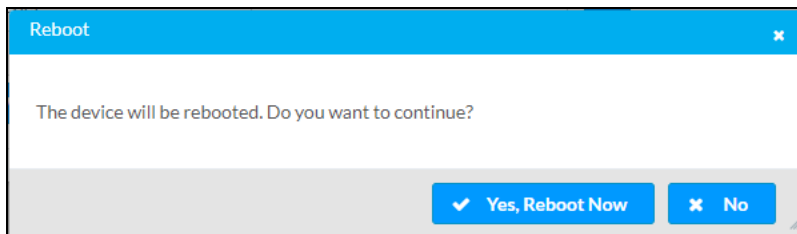

3. Select **Yes, Reboot Now** to reboot the device at the current time or select **No** to reboot the device at a later time.

If **Yes, Reboot Now** is selected, the **Reboot** message box appears, indicating that the device is rebooting. In addition, a progress indicator bar displays the percentage of completion of the reboot process. When the reboot process is complete, the progress indicator bar displays 100%.

Reboot Message Box

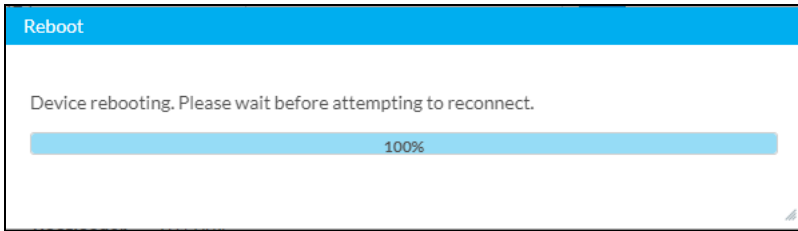

The Device Administration page opens, enabling sign-in to the device.

Managing EDIDs

To view the list of default EDIDs or to add or delete user EDIDs:

In the **Action** menu located in the upper-right corner of the web interface, select **Manage EDIDs**.

Action Menu - Manage EDIDs

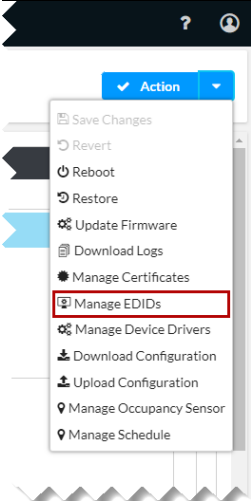

The **Manage EDIDs** pop-up dialog box opens.

Manage EDIDs Pop-Up Dialog Box

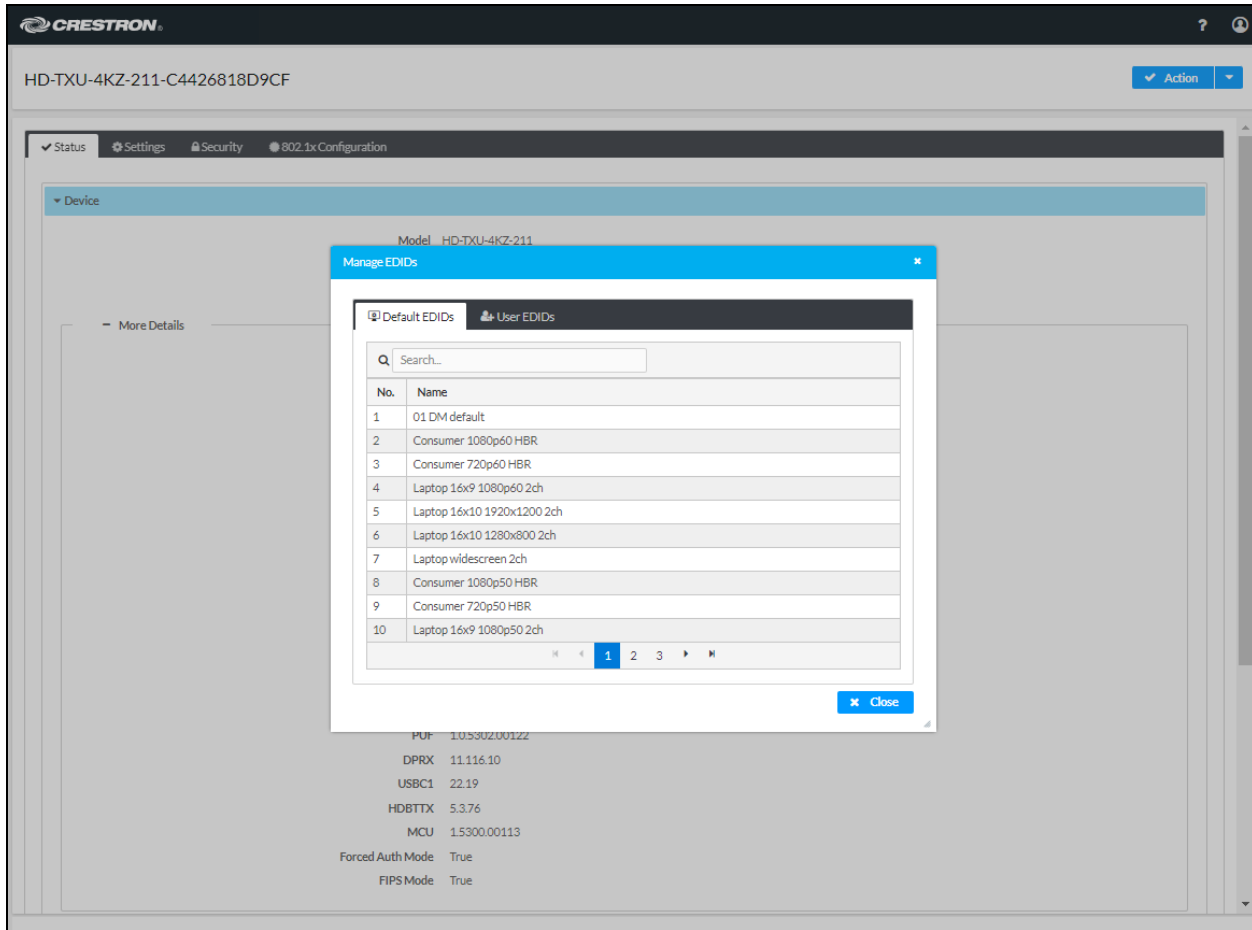

The **Manage EDIDs** pop-up dialog box provides the following tabs:

- **Default EDIDs** (refer to [Viewing Default EDIDs](#) for information)
- **User EDIDs** (refer to [Managing User EDIDs](#) for information)

Viewing Default EDIDs

In the **Manage EDIDs** pop-up dialog box, select the **Default EDIDs** tab to view all default EDIDs. By default, the **Default EDIDs** tab is displayed when the dialog box opens.

Manage EDIDs Pop-Up Dialog Box, Default EDIDs Tab

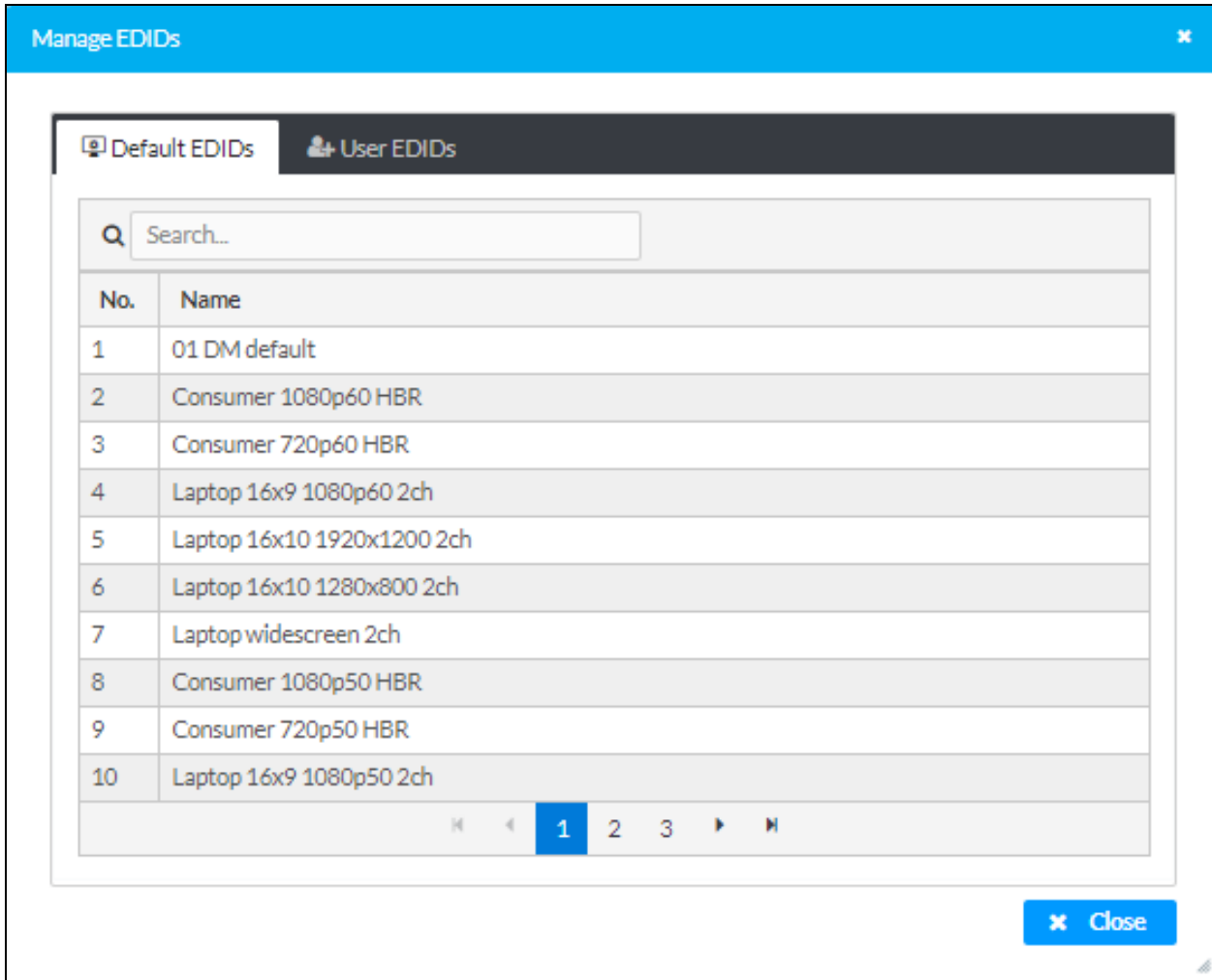

Up to 10 default EDIDs are displayed in the table simultaneously. To locate additional EDIDs in the table:

- Use the Search box above the table.
- Use the scroll arrows at the bottom of the table to navigate through the list of EDIDs.

Managing User EDIDs

In the **Manage EDIDs** pop-up dialog box, select the **User EDIDs** tab to view, add, or delete user (custom) EDIDs.

Manage EDIDs Pop-Up Dialog Box, User EDIDs Tab

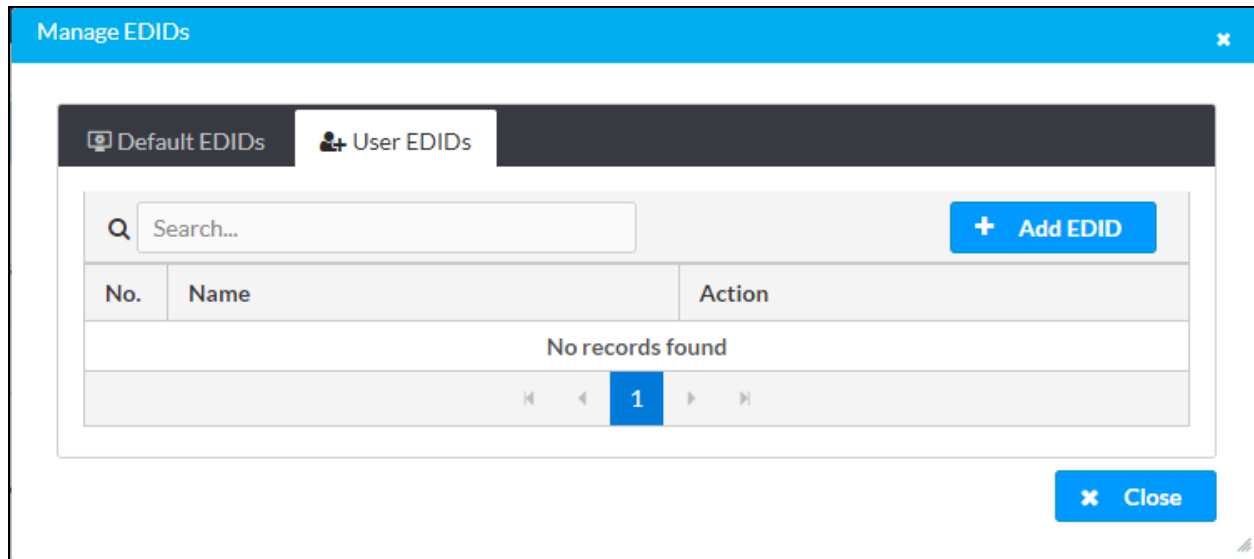

Up to 10 user EDIDs can be displayed in the table simultaneously. If the number of user EDIDs exceeds 10, do either of the following to locate one or more EDIDs in the table:

- Use the Search box above the table.
- Use the scroll arrows at the bottom of the table to navigate through the list of EDIDs.

[Add](#) or [delete](#) user EDIDs as required.

Add a User EDID

To add a user EDID (*.cedid):

1. In the **User EDIDs** tab, select the **Add EDID** button.

The **File Upload - Browse** dialog box opens.

File Upload - Browse Dialog Box

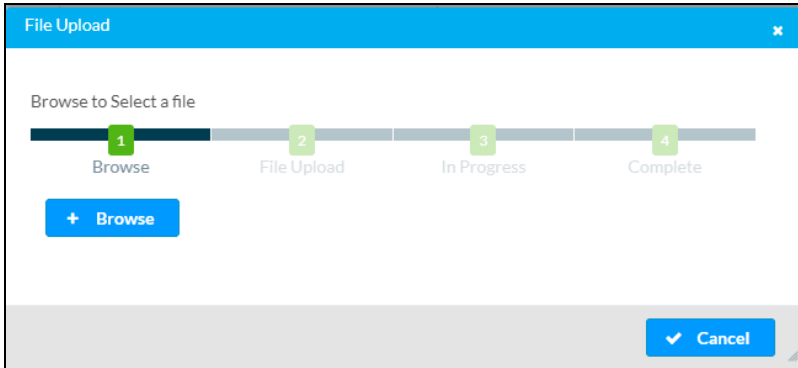

2. Select **Browse**. File Explorer opens.
3. Navigate to the desired EDID file (*.cedid), select the file, and then select **Open**.

The **File Upload - Load** dialog box opens.

File Upload - Load Dialog Box

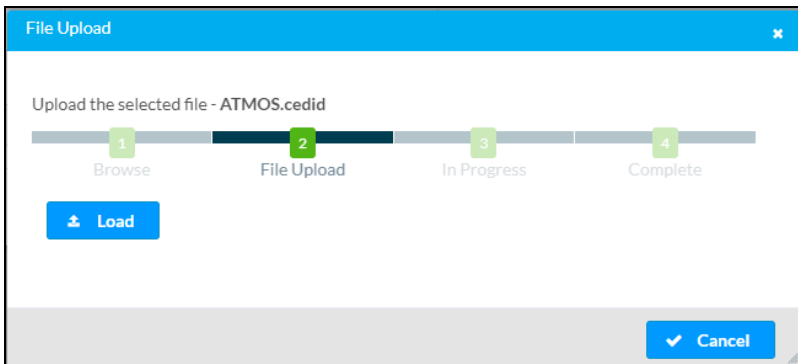

4. Select **Load**.

When the file upload process is complete, the **File upload is complete** message appears in the **File Upload - Complete** dialog box.

File Upload - Complete Dialog Box

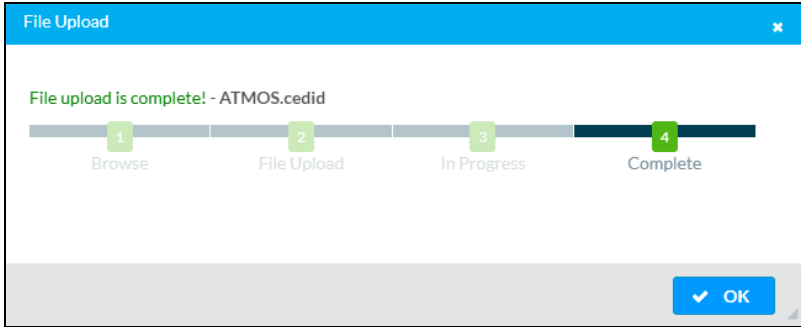

5. Select **OK** to close the dialog box.

The newly added EDID file is listed in the User EDIDs table as shown in the example below.

Addition of User EDID

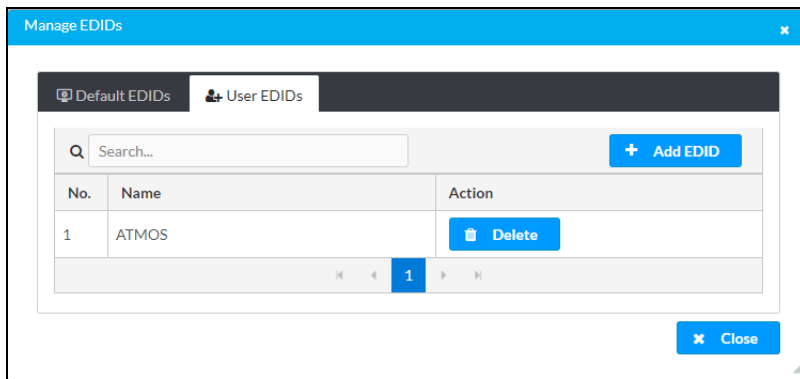

Delete a User EDID

To delete a user EDID:

1. In the **Action** column of the User EDIDs table, select the **Delete** button corresponding to the EDID to be deleted.

The **Delete EDID** dialog box opens, prompting for confirmation that the EDID be deleted.

Delete EDID Dialog Box

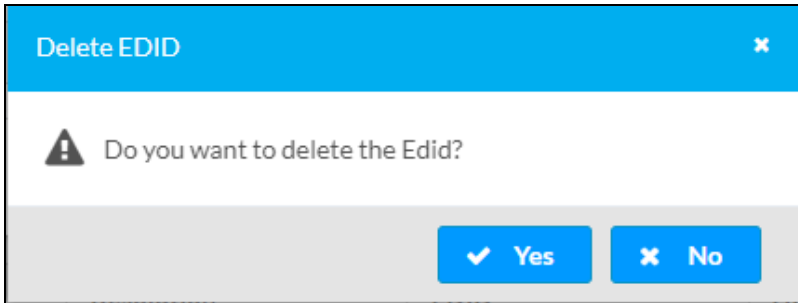

2. Select **Yes** to delete the EDID.
3. In the **Manage EDIDs** pop-up dialog box, select **Close** to close the dialog box.

Managing Device Drivers

To manage device drivers:

In the **Action** menu located in the upper-right corner of the web interface, select **Manage Device Drivers**.

Action Menu - Manage Device Drivers

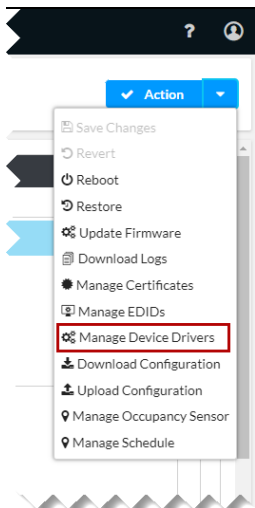

The **Manage Device Drivers** pop-up dialog box opens.

Manage Device Drivers Pop-Up Dialog Box

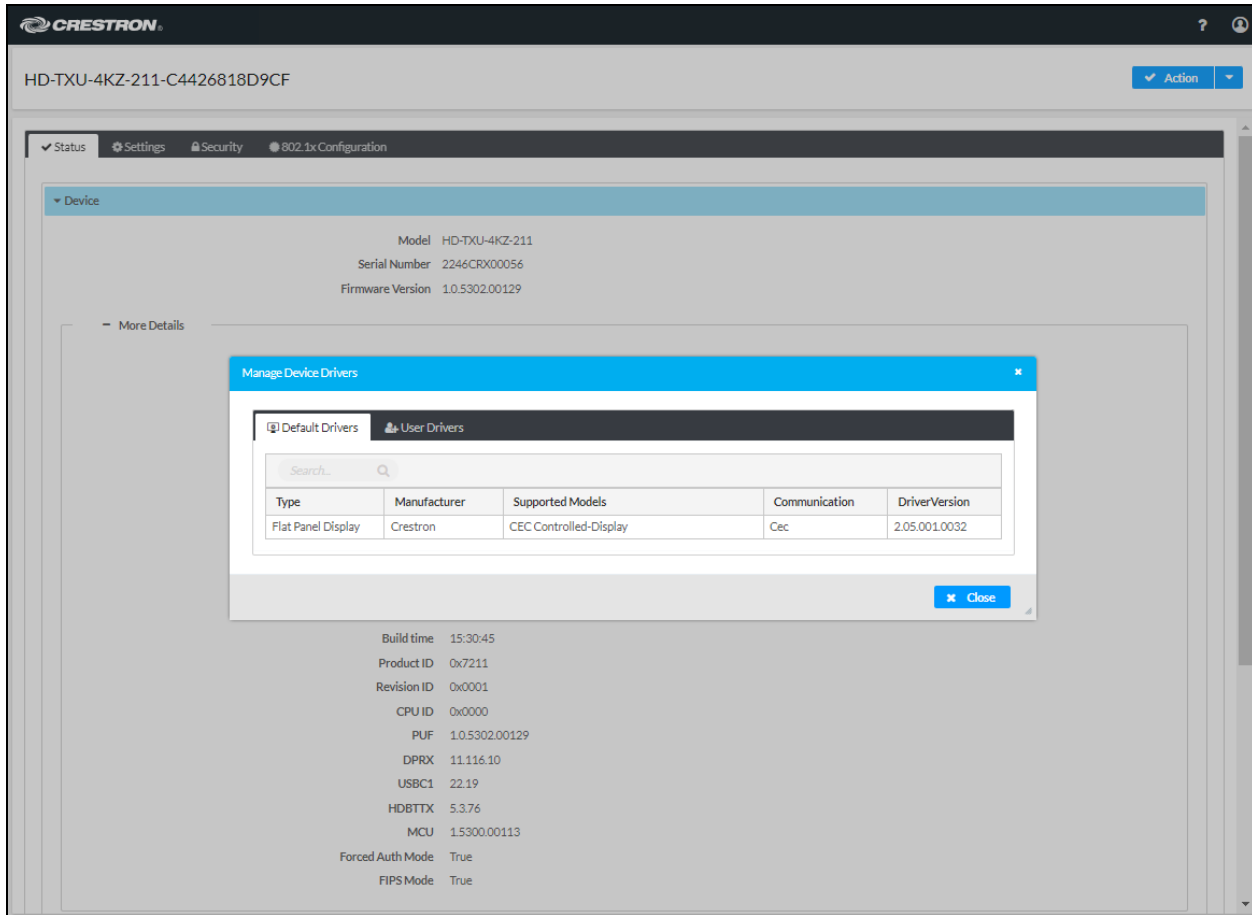

The **Manage Device Drivers** pop-up dialog box provides the following tabs:

- **Default Drivers** (refer to [Viewing Default Drivers](#) for information)
- **User Drivers** (refer to [Managing User Drivers](#) for information)

Viewing Default Drivers

In the **Manage Device Drivers** pop-up dialog box, select the **Default Drivers** tab to view the default driver. By default, the **Default Drivers** tab is displayed when the **Manage Device Drivers** pop-up dialog box opens.

Manage Device Drivers Pop-Up Dialog Box, Default Drivers Tab

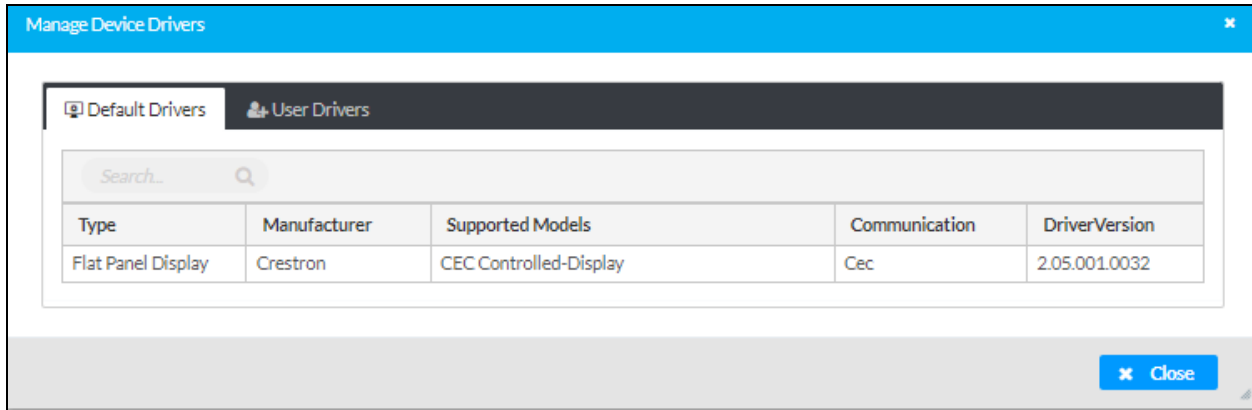

The Default Drivers table consists of a single default driver as listed in the screen above.

Managing User Drivers

In the **Manage Device Drivers** pop-up dialog box, select the **User Drivers** tab to view, add, or delete user (custom) drivers.

Manage Device Drivers Pop-Up Dialog Box, User Drivers Tab

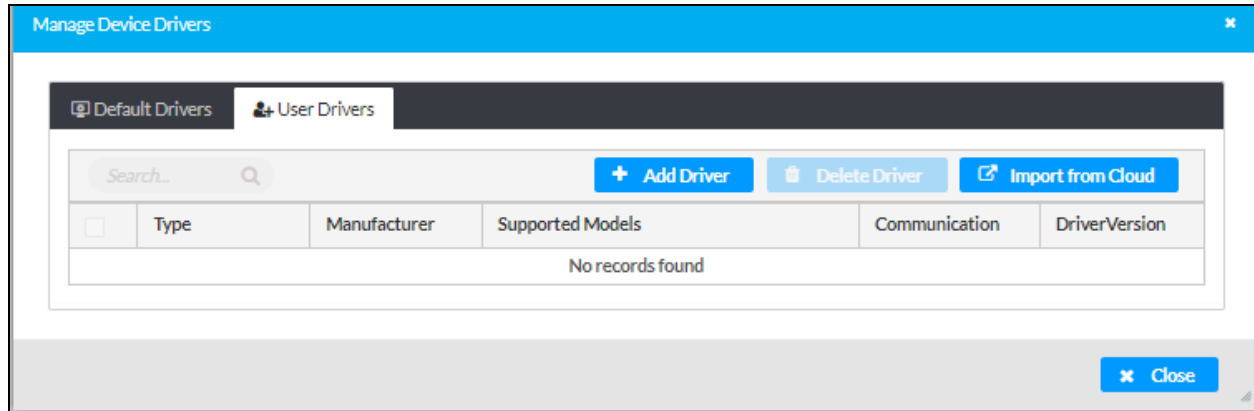

Up to 5 user drivers can be displayed in the table simultaneously. If the number of user drivers exceeds 5, do either of the following to locate one or more drivers in the table:

- Use the Search box above the table.
- Use the scroll arrows at the bottom of the table to navigate through the list of drivers. The scroll arrows become visible when the number of user drivers exceeds 5.

To manage user drivers, [add](#) or [delete](#) drivers as required.

Add a User Driver

To add a user driver, do either or both of the following:

- Use the **Add Driver** button.
- Use the **Import from Cloud** button.

Use the Add Driver Button

To add a user driver using the **Add Driver** button:

1. In the **User Drivers** tab, select the **Add Driver** button.

User Drivers Tab - Add Driver Button

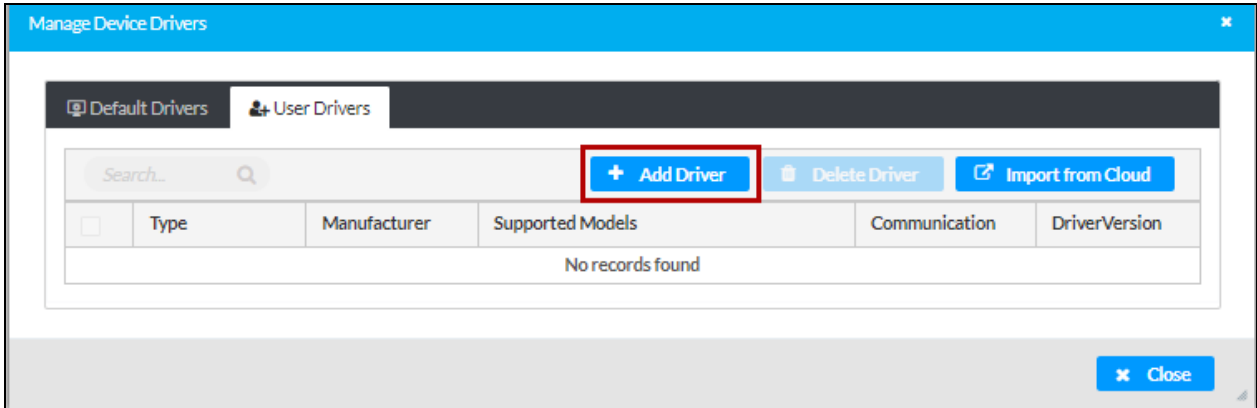

The **File Upload - Browse** dialog box opens.

File Upload - Browse Dialog Box

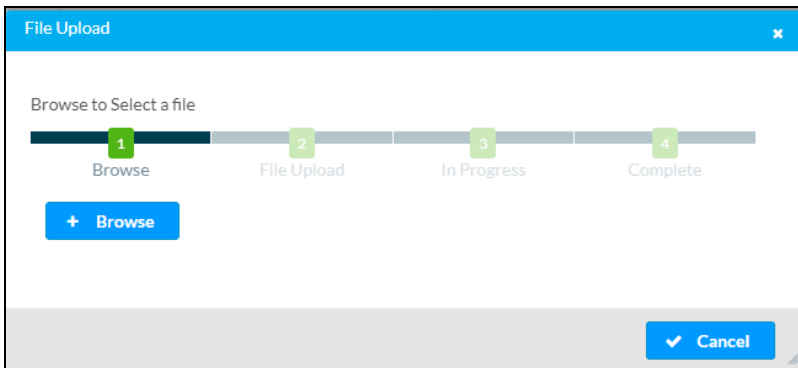

2. Select **Browse**. File Explorer opens.
3. Navigate to the desired driver file (*.pkg), select the file, and then select **Open**.

The **File Upload** dialog box opens.

File Upload Dialog Box



4. Select **Upload**.

When the file upload process is complete, the **File upload is complete** message appears in the **File Upload - Complete** dialog box.

File Upload - Complete Dialog Box

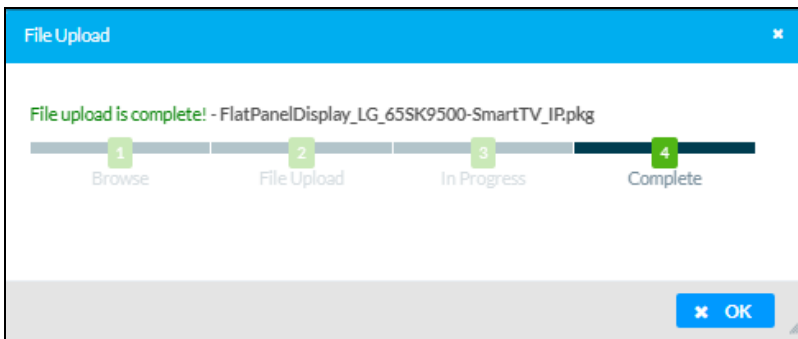

5. Select **OK** to close the dialog box.

The newly added driver file is listed in the User Drivers table as shown in the example below.

Addition of User Driver

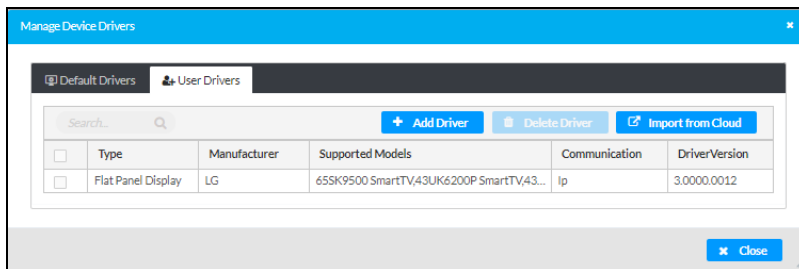

Use the Import from Cloud Button--Does this have anything to do with XiO Cloud?????

As its name implies, the **Import from Cloud** button is used to import user drivers from the cloud.

To add a user driver using the **Import from Cloud** button:

1. In the **User Drivers** tab, select the **Import from Cloud** button.

User Drivers Tab - Import from Cloud Button

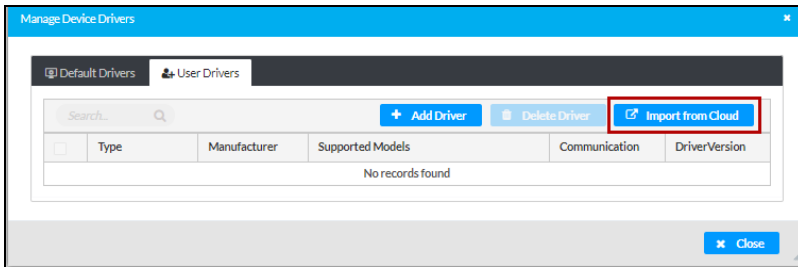

The **Import a Driver** pop-up dialog box opens, providing a list of available drivers with 5 drivers displayed simultaneously.

Import a Driver Pop-Up Dialog Box

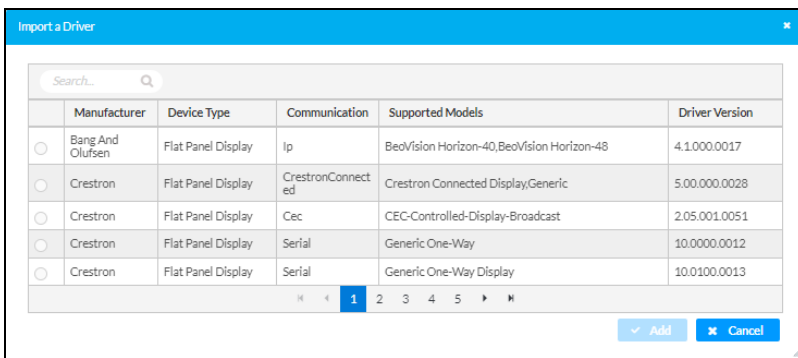

2. Locate the desired driver by using the Search box above the table or use the scroll arrows at the bottom of the table to navigate through the list of drivers.
3. Select the checkbox corresponding to the desired driver, and then select the **Add** button.
The driver is added to the User Drivers table.
4. Repeat steps 1-4 for each driver to be imported from the cloud.
5. Select **Close** to close the **Manage Device Drivers** dialog box.

Delete a User Driver

To delete one or more user drivers listed in the User Drivers table:

1. Do either of the following:
 - To delete all user drivers simultaneously, select the topmost checkbox in the first column of the table. All checkboxes for all drivers on all pages of the table are automatically selected.

All Drivers Selected Simultaneously

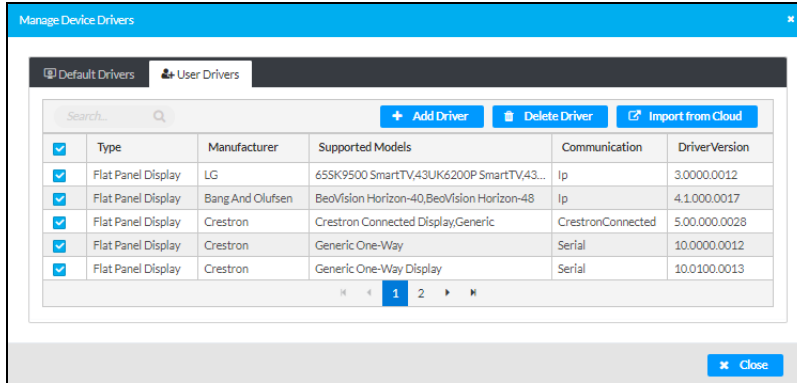

- To delete one or more user drivers on an individual basis, select the checkbox of the corresponding drivers.

Multiple Drivers Selected on an Individual Basis

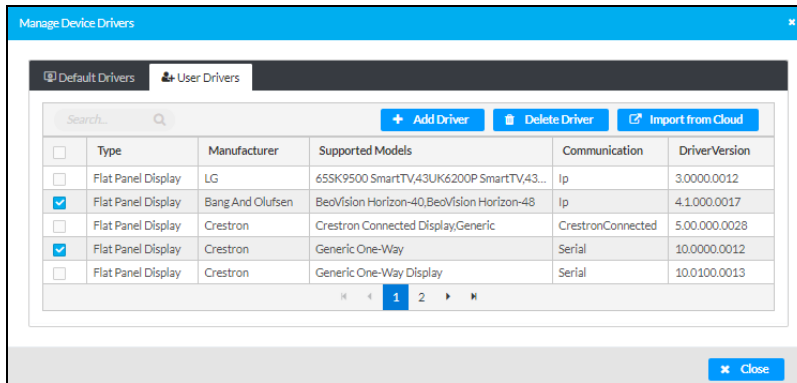

2. Select the **Delete Driver** button.

Delete Driver Button

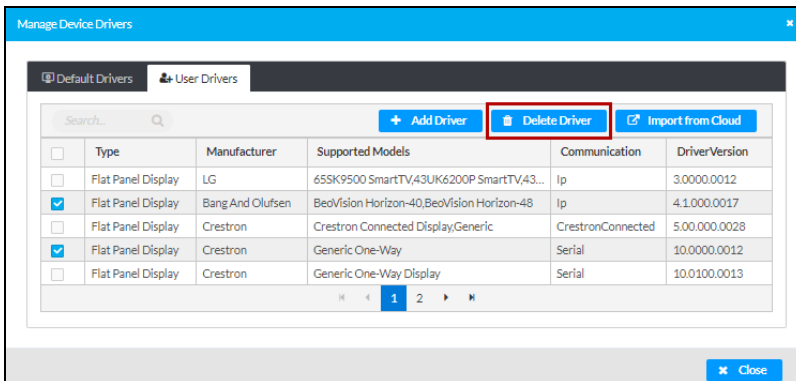

The selected drivers are deleted from the table.

3. Select **Close** to close the **Manage Device Drivers** dialog box.

Downloading a Configuration File

The configuration of the HD-TXU-4KZ-211(-CHGR) or HD-RXU-4KZ-202 can be downloaded to a computer as an *.tgz file. The configuration file provides a backup of the device configuration and can be used for uploading to a replacement HD-TXU-4KZ-211(-CHGR) or HD-RXU-4KZ-202.

To download a configuration file:

1. In the **Action** menu located in the upper-right corner of the web interface, select **Download Configuration**.

Action Menu - Download Configuration

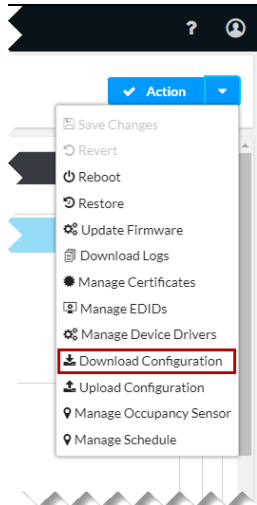

The configuration file is downloaded to the **Downloads** folder of the computer using the following naming convention:

model_config_yyyy.mm.dd_hh.mm.ss.tgz

- *model* is the model name of the device
- *yyyy.mm.dd* is the 4-digit year, 2-digit month, and 2-digit day separated by hyphens
- *hh.mm.ss* is the 2-digit hour, 2-digit minutes, and 2-digit seconds separated by hyphens in 24-hour format

Example: hd-txu-4kz-211_config_2023.10.02_11.31.28.tgz

To upload a configuration file to a replacement HD-TXU-4KZ-211(-CHGR) or HD-RXU-4KZ-202, refer to [Uploading a Configuration File](#).

Uploading a Configuration File

A configuration file (*.tgz) that was downloaded from an HD-TXU-4KZ-211(-CHGR) or HD-RXU-4KZ-202 being replaced can be uploaded to the replacement device.

To upload a configuration file:

1. In the **Action** menu located in the upper-right corner of the web interface, select **Upload Configuration**.

Action Menu - Upload Configuration

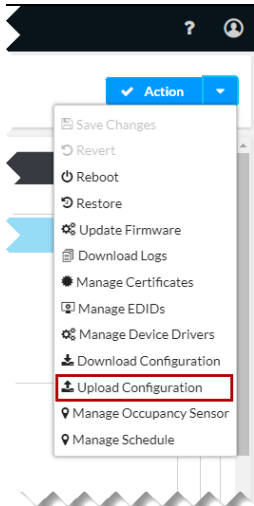

The **Device Configuration - Browse** dialog box opens.

Device Configuration - Browse Dialog Box

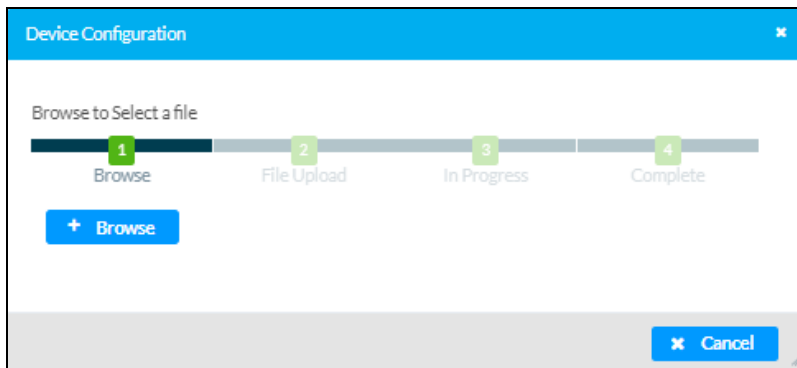

2. Select **Browse**. File Explorer opens.
3. Navigate to the configuration file (*.tgz), select the file, and then select **Open**.

The **Device Configuration - Upload** dialog box opens.

Device Configuration - Upload Dialog Box

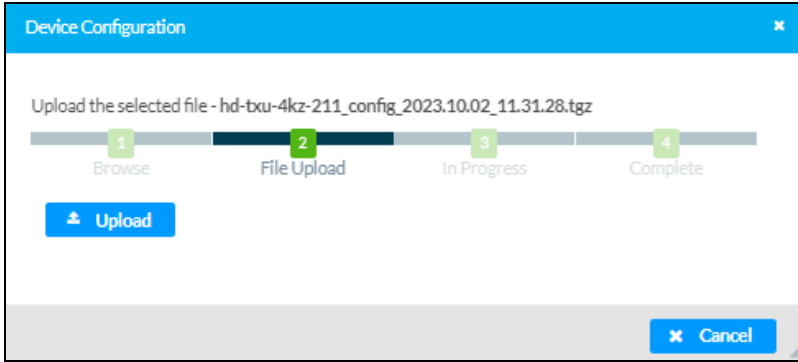

4. Select **Upload**.

A message box opens indicating that the file is being uploaded.

Upload Message Box

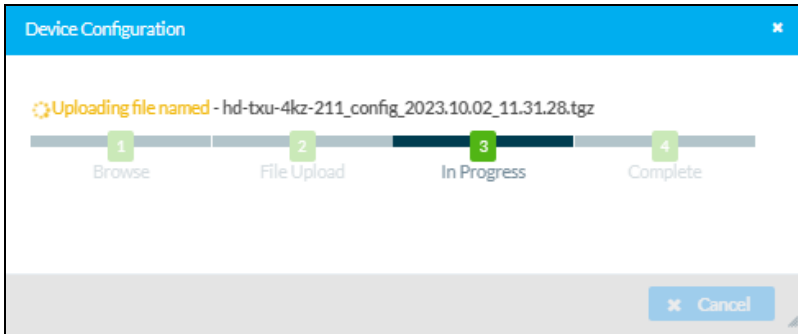

The **Reboot** dialog box then opens, prompting for confirmation that the device be rebooted in order for the changes to take effect.

Reboot Dialog Box

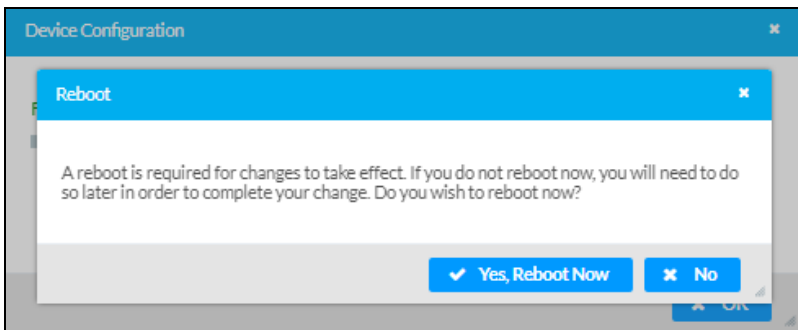

5. Select **Yes, Reboot Now** to reboot the device at the current time or select **No** to reboot the device at a later time.

If **Yes, Reboot Now** is selected, the Reboot message box appears, indicating that the device is rebooting. In addition, a progress indicator bar displays the percentage of completion of the reboot process. When the reboot process is complete, the progress indicator bar displays 100%.

Reboot Message Box

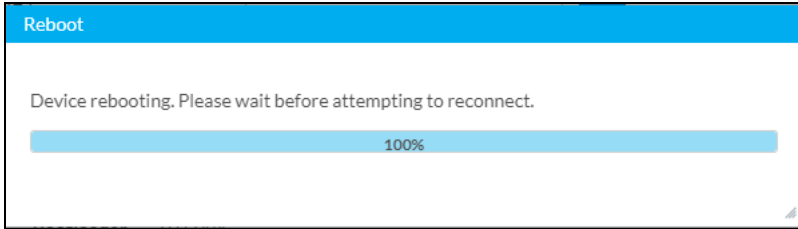

The Device Administration page opens, enabling sign-in to the device.

Managing an Occupancy Sensor

An occupancy sensor that is accessible from the network can be used to control automatic display power of an output.

To add or delete an occupancy sensor, do either of the following:

- In the **Action** menu located in the upper-right corner of the web interface, select **Manage Occupancy Sensor**.

Action Menu - Manage Occupancy Sensor

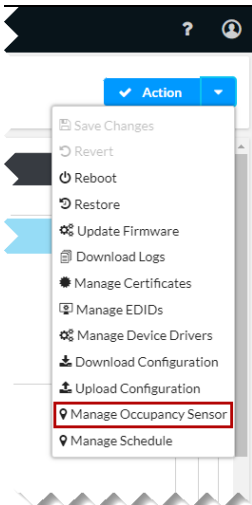

- In the **Settings** tab, navigate to **Outputs** and then select the **Edit** button.

In the **Edit Output** pop-up dialog box, go to the **Automatic Display Power** section, set the **Automatic Power Trigger** to include **Occupancy**, and then select the **Manage Occupancy Sensor** button.

Settings Tab - Outputs, Edit Output Pop-Up Dialog Box, Automatic Display Power, Manage Occupancy Sensor Button

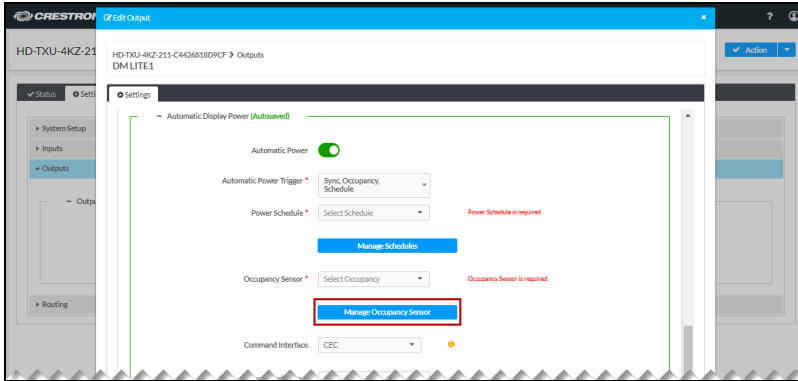

The **Manage Occupancy Sensor** pop-up dialog box opens.

Manage Occupancy Sensor Pop-Up Dialog Box

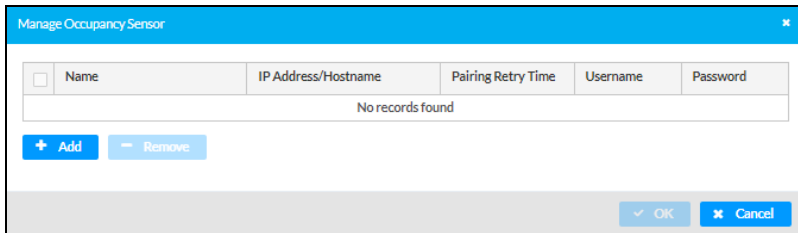

[Add](#) or [remove](#) an occupancy sensor as required.

Adding an Occupancy Sensor

To add an occupancy sensor that is accessible on the network:

1. In the **Manage Occupancy Sensor** pop-up dialog box, select the **Add** button.

Manage Occupancy Sensor Pop-Up Dialog Box - Add Button

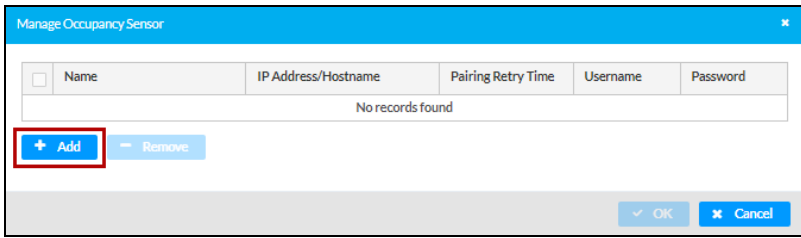

The screenshot shows the 'Manage Occupancy Sensor' dialog box. It features a table with columns: Name, IP Address/Hostname, Pairing Retry Time, Username, and Password. The table is currently empty with the text 'No records found' below it. Below the table are two buttons: '+ Add' (highlighted with a red box) and '- Remove'. At the bottom right are 'OK' and 'Cancel' buttons.

A row is added to the Manage Occupancy Sensor table, enabling an occupancy sensor to be added.

Manage Occupancy Sensor Pop-Up Dialog Box for Addition of Occupancy Sensor

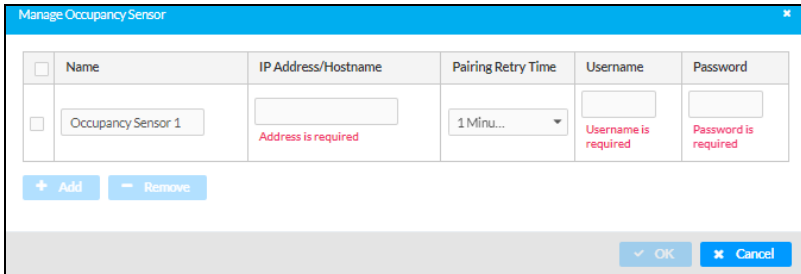

The screenshot shows the 'Manage Occupancy Sensor' dialog box with a new row added. The row contains: Name: 'Occupancy Sensor 1', IP Address/Hostname: an empty field with a red error message 'Address is required', Pairing Retry Time: a dropdown menu set to '1 Minu...', Username: an empty field with a red error message 'Username is required', and Password: an empty field with a red error message 'Password is required'. Below the table are '+ Add' and '- Remove' buttons. At the bottom right are 'OK' and 'Cancel' buttons.

2. Complete the following entries:

- **Name:** Enter the desired name for the occupancy sensor. The default name of the occupancy sensor is **Occupancy Sensor 1**.
- **IP Address/Hostname:** Enter the IP address or hostname of the occupancy sensor.
- **Pairing Retry Time:** Enter the number of seconds that must pass after a failed attempt at pairing with the HD-TX-4KZ-211(-CHGR) or HD-RXU-4KZ-202 before the occupancy sensor attempts to retry pairing with the HD-TX-4KZ-211(-CHGR) or HD-RXU-4KZ-202. Available values are **1 Minute, 2 Minutes, 3 Minutes, 4 Minutes, or 5 Minutes**.
- **Username:** Enter the username assigned to the occupancy sensor.
- **Password:** Enter the password assigned to the occupancy sensor.

3. Select **OK** to add the occupancy sensor.

Addition of Occupancy Sensor

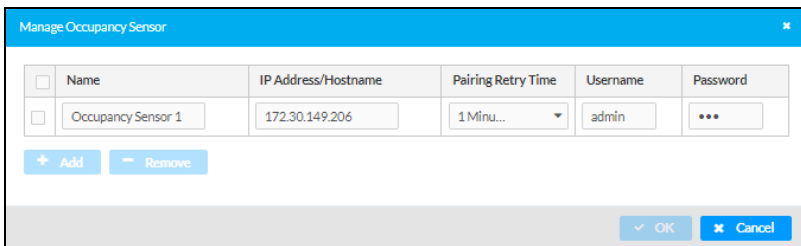

The screenshot shows the 'Manage Occupancy Sensor' dialog box with the sensor successfully added. The row now contains: Name: 'Occupancy Sensor 1', IP Address/Hostname: '172.30.149.206', Pairing Retry Time: '1 Minu...', Username: 'admin', and Password: '***'. Below the table are '+ Add' and '- Remove' buttons. At the bottom right are 'OK' and 'Cancel' buttons.

Removing an Occupancy Sensor

To remove an occupancy sensor:

1. In the Manage Occupancy Sensor table, select the checkbox of the occupancy sensor to be removed.

Selection of Occupancy Sensor for Removal

<input type="checkbox"/>	Name	IP Address/Hostname	Pairing Retry Time	Username	Password
<input checked="" type="checkbox"/>	Occupancy Sensor 1	172.30.149.206	1 Minu...	admin	***

+ Add - Remove

OK Cancel

2. Select the **Remove** button. The occupancy sensor is removed from the Manage Occupancy Sensor table.

Managing Schedules

Schedules can be added or deleted to control automatic display power of an output.

To add or delete schedules, do either of the following:

- In the **Action** menu located in the upper-right corner of the web interface, select **Manage Schedule**.

Action Menu - Manage Schedule

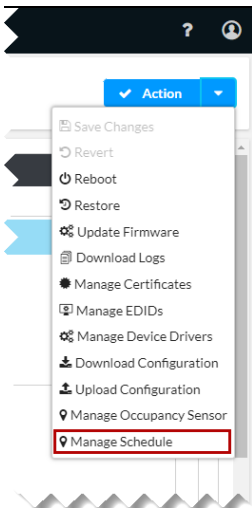

- In the **Settings** tab, navigate to **Outputs** and then select the **Edit** button.

In the **Edit Output** pop-up dialog box, go to the **Automatic Display Power** section, set the **Automatic Power Trigger** to include **Schedule**, and then select the **Manage Schedules** button.

Settings Tab - Outputs, Edit Output Pop-Up Dialog Box, Automatic Display Power, Manage Schedules Button

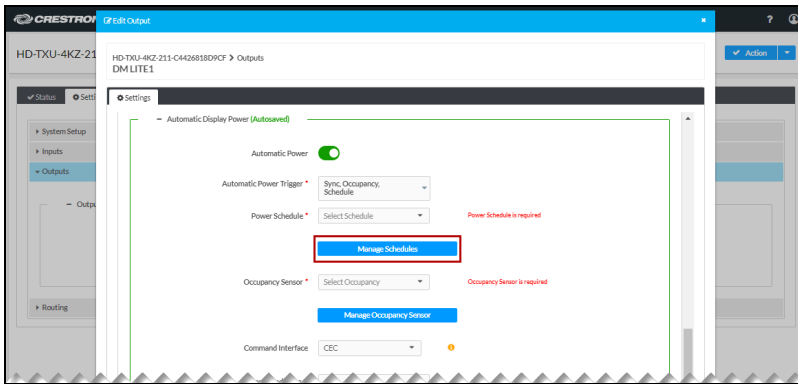

The **Manage Schedule** pop-up dialog box opens.

Manage Schedule Pop-Up Dialog Box

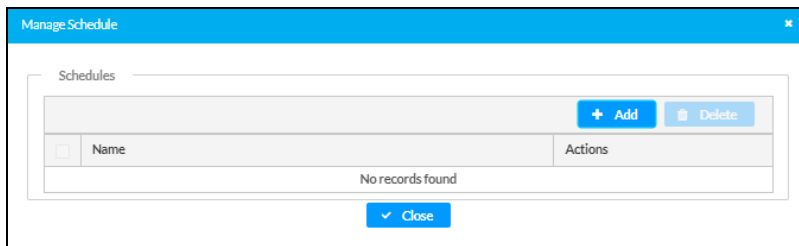

[Add](#) or [delete](#) schedules as required.

Adding a Schedule

A maximum of 10 schedules can be added.

To add a schedule:

1. In the **Manage Schedule** pop-up dialog box, select the **Add** button.

Manage Schedule Pop-Up Dialog Box - Add Button

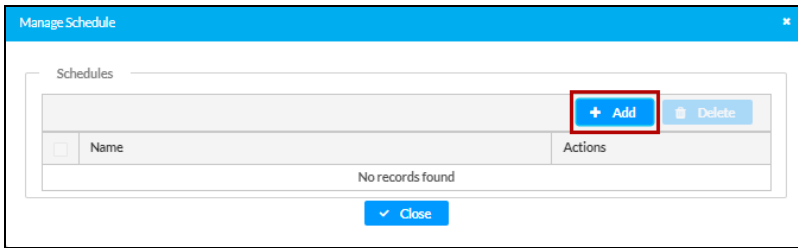

The **Add Schedule** pop-up dialog box opens.

Add Schedule Pop-Up Dialog Box

Enabled	Day	On Time	Off Time
<input checked="" type="checkbox"/>	Monday	00:00	23:59
<input checked="" type="checkbox"/>	Tuesday	00:00	23:59
<input checked="" type="checkbox"/>	Wednesday	00:00	23:59
<input checked="" type="checkbox"/>	Thursday	00:00	23:59
<input checked="" type="checkbox"/>	Friday	00:00	23:59
<input type="checkbox"/>	Saturday	00:00	23:59
<input type="checkbox"/>	Sunday	00:00	23:59

2. Set a schedule as follows:
 - a. In the **Name** text box, enter a name for the desired schedule.
 - b. In the **Enabled** column of the table, set the toggle switch in the On or Off position for the corresponding day of the week (**Monday**, **Tuesday**, and so on). If the toggle switch is in the On position, the schedule is enabled for the corresponding day. If the toggle switch is in the Off position, the schedule is disabled for the corresponding day. By default, **Monday**, **Tuesday**, **Wednesday**, **Thursday**, and **Friday** are enabled, and **Saturday** and **Sunday** are disabled.
 - c. In the **On Time** column, set the desired starting time in 24-hour format (hh:mm) for each day that is enabled in the **Enabled** column. The default starting time is **00:00**.
 - d. In the **Off Time** column, set the desired ending time in 24-hour format (hh:mm) for each day that is enabled in the **Enabled** column. The default ending time is **23:59**.
 - e. Select **OK** to set the schedule.

The name of the schedule is listed in the **Manage Schedule** pop-up dialog box, for example, **Schedule 1**.

Addition of Single Schedule

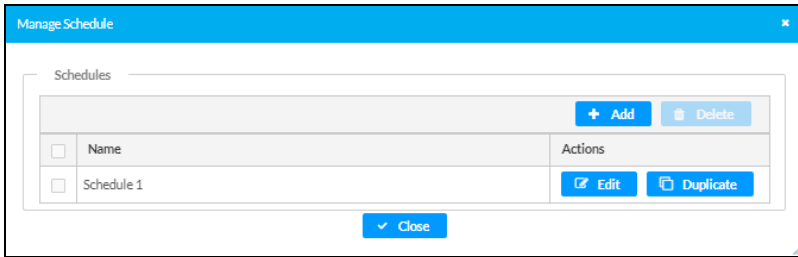

- (Optional) If additional schedules are needed (maximum of 10), repeat steps 2 and 3 for each schedule to be added. A maximum of 5 schedules is displayed simultaneously in the table. If more than 5 schedules are added, use the scroll arrows at the bottom of the table to navigate through the list of schedules.

Addition of Multiple Schedules

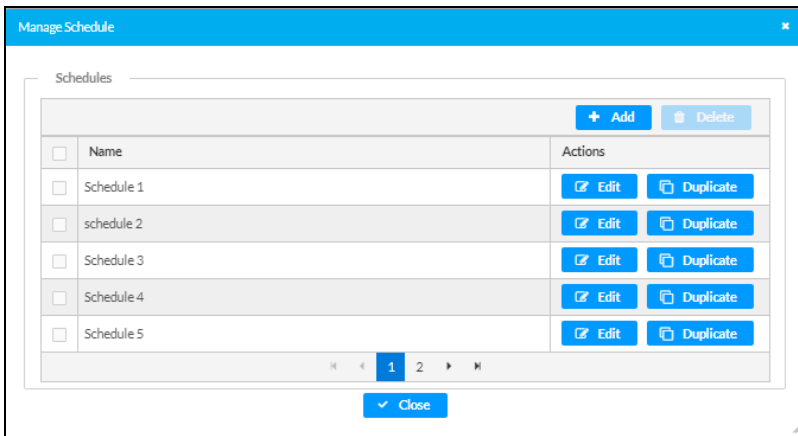

A schedule can be edited or duplicated as necessary. Refer to [Edit a Schedule](#) or [Duplicate a Schedule](#), respectively, for information.

To delete a schedule, refer to [Deleting a Schedule](#) for information.

Edit a Schedule

To edit a schedule listed in the **Manage Schedule** pop-up dialog box:

1. In the **Actions** column of the **Schedules** table, select the **Edit** button corresponding to the schedule to be edited.

Manage Schedule Pop-Up Dialog Box - Edit Button

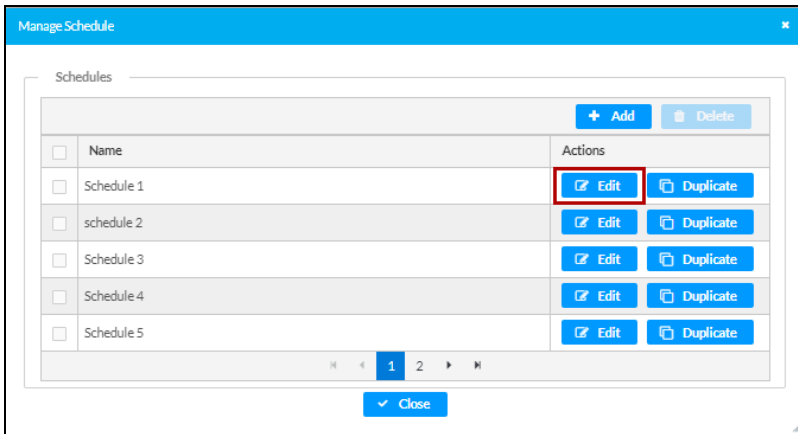

The Edit Schedule pop-up dialog box opens.

Edit Schedule Pop-Up Dialog Box

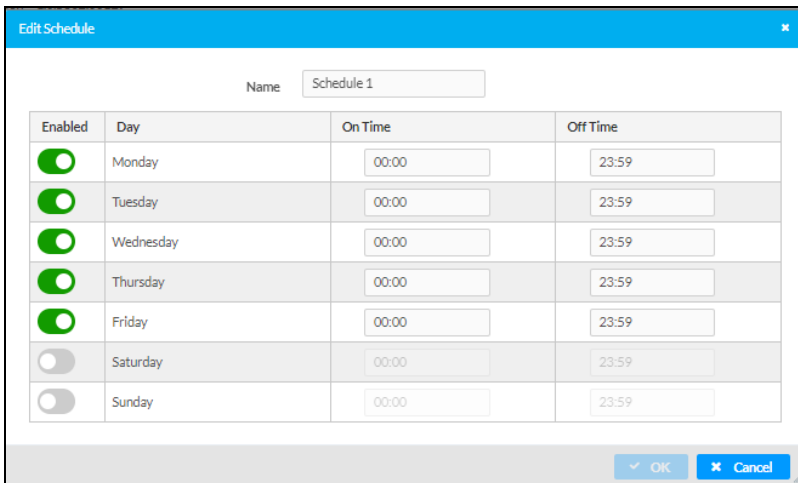

2. If desired, edit the **Name** of the schedule. For one or more days (**Monday** through **Sunday**), edit the following settings as desired: **Enabled** (enable or disable the corresponding day), **On Time**, and **Off Time**.
3. Select **OK** to save the schedule.
4. (Optional) Repeat steps 1-3 for each schedule to be edited.
5. Select **Close** to close the **Manage Schedule** dialog box.

Duplicate a Schedule

NOTE: A maximum of 10 schedules is supported.

To duplicate a schedule listed in the **Manage Schedule** dialog box:

1. In the **Actions** column of the **Schedules** table, select the **Duplicate** button corresponding to the schedule to be duplicated.

Manage Schedule Pop-Up Dialog Box - Duplicate Button

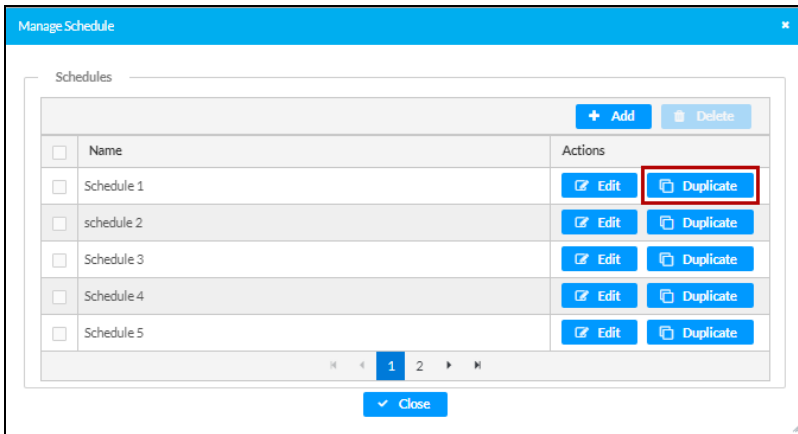

The duplicated schedule is added to the end of the **Schedules** table. The name of the duplicated schedule is appended by a hyphen (-) and a number based on the order in which the schedule was added to the list.

2. Edit the duplicated schedule as required. For information, refer to [Editing a Schedule](#).

Deleting a Schedule

To delete one or more schedules listed in the **Manage Schedule** pop-up dialog box:

1. In the first column of the **Schedules** table, select one or more checkboxes corresponding to the schedules to be deleted. If all schedules are to be deleted, select the topmost checkbox in the first column of the table. All checkboxes for all schedules in the table (maximum of 10) are automatically selected.

Three Schedules Selected for Deletion

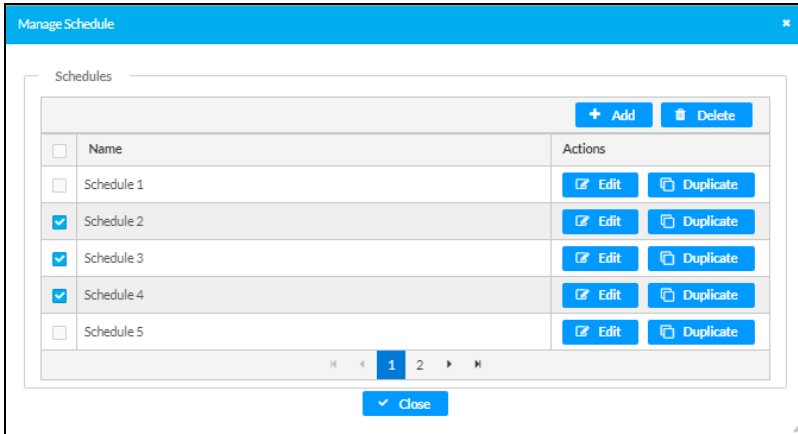

All Schedules Selected for Deletion

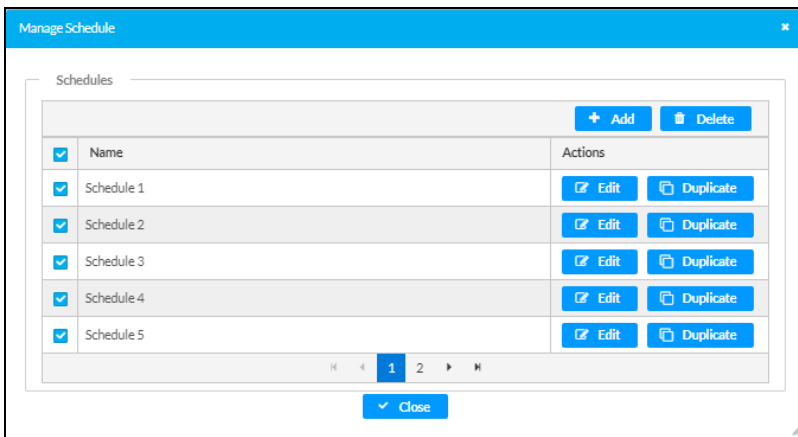

2. Select the **Delete** button. The **Delete Schedule** pop-up dialog box opens, prompting for confirmation that the selected schedule be deleted.

Delete Schedule Pop-Up Dialog Box

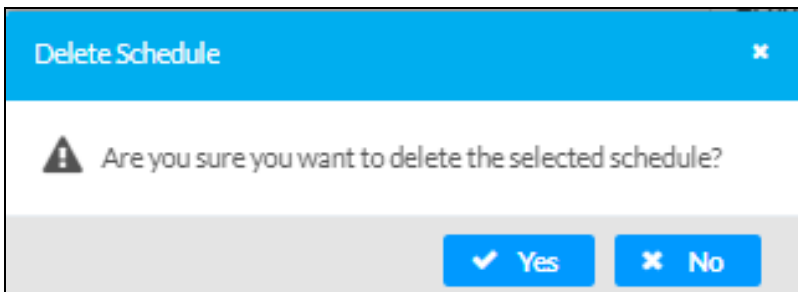

3. Select **Yes** to delete the selected schedules. The schedules are deleted from the **Schedules** table.
4. Select **Close** to close the **Manage Schedule** pop-up dialog box.

Resources

For additional information, refer to the following resources.

Crestron Support and Training

- [Crestron True Blue Support](#)
- [Crestron Resource Library](#)
- [Crestron Online Help \(OLH\)](#)
- [Crestron Training Institute \(CTI\) Portal](#)

Programmer and Developer Resources

- help.crestron.com: Provides help files for Crestron programming tools such as SIMPL, SIMPL#, and Crestron Toolbox™ software
- developer.crestron.com: Provides developer documentation for Crestron APIs, SDKs, and other development tools

Product Certificates

To search for product certificates, refer to support.crestron.com/app/certificates.

